

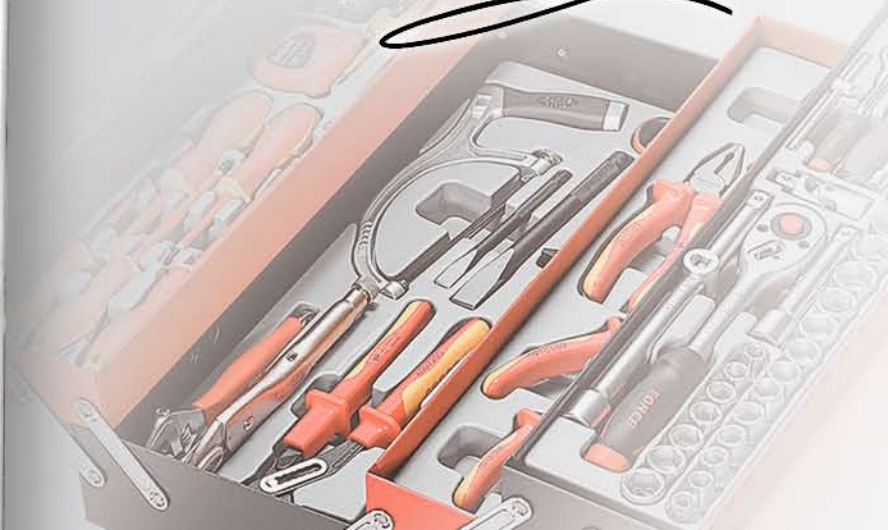

FORCE®

**GENERAL
CATALOGUE
V9**

Power you on





General Information

This catalogue replaces all previous editions. All rights reserved in all countries. Reprinting and excerpts require a prior permission in writing by Shyang Yun Tools Co., Ltd.

The photographs and the technical details are of the articles at present offered.

Since we are constantly updating and improving our products to meet user needs and technological developments, we reserve the right to make modifications and changes with regard to photographs, specifications, sizes, packing, weights and performance without notice.

There is no liability for printing errors and correction or replacement supplies with regard to products already delivered. Cancellations of all models and sets may be made at any time without there being any grounds for legal claim.

FORCE is a registered trademark.

All other trademarks mentioned in this document or website are the property of their respective owners.

The use of the word partner does not imply a partnership relationship between Shyang Yun Tools Co., Ltd. and any other company.

© Copyright by Shyang Yun Tools Co., Ltd.
All rights reserved.



INDEX

GENERAL CATALOGUE V9

Anything you need for tools...



P.1-1~1-14

**Trolleys,
Tool boxes,
Suitcases,
Workbenches,
Cabinets.**



**Torque wrench,
Pliers,
Hammers,
Pullers,
Insulated tools,
Auto special tools**

P.2-1~2-152



**Wrenches,
Ratchet wrenches**

P.3-1~3-46



**Bits,
Screwdrivers,
L keys,
T-handle tools**

P.4-1~4-76



**1/4"DR. Hand tools:
Sockets,
Socket bits,
Ratchet handles,
Accessories**

P.5-1~5-28



**3/8"DR. Hand tools:
Sockets,
Socket bits,
Ratchet handles,
Accessories**

P.6-1~6-32



**1/2"DR. Hand tools:
Sockets,
Socket bits,
Ratchet handles,
Accessories**

P.7-1~7-74



**3/4"DR. Hand tools:
Sockets,
Socket bits,
Ratchet handles,
Accessories**

P.8-1~8-10



**1"DR. Hand tools:
Sockets,
Socket bits,
Ratchet handles,
Accessories**

P.9-1~9-4



**Impact sockets,
Impact wrenches,
Cordless tools**

P.10-1~10-70

Tool bag with 95pc tools

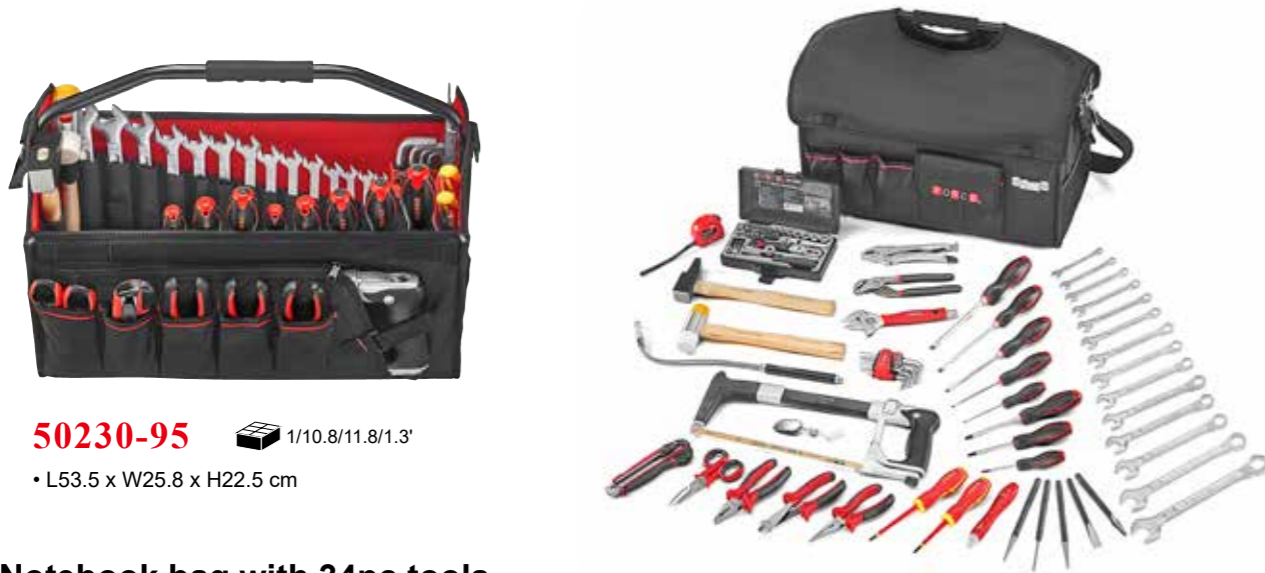

50230-95  1/10.8/11.8/1.3'
• L53.5 x W25.8 x H22.5 cm

Notebook bag with 34pc tools



50231-33  5/20/21/1.2'
• L38.5 x W24 x H5 cm

Black suitcase / with 107pc tools



50234  1/4.5/5.3/1.65'
• L45 x W33 x H15 cm

50234-107  1/12.9/13.9/1.65'

3-Layer / 5-Layer tool box



50233  1/6/7/1.5'
• L53.5 x W25.8 x H16.5 cm

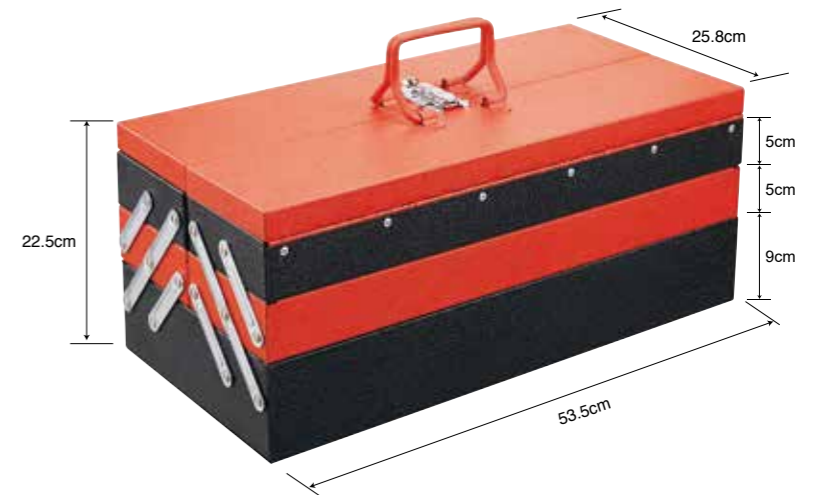

50235  1/7.6/9/1.9'
• L53.5 x W25.8 x H22.5 cm

3-Layer tool box with 76pc tool

NEW



50233-76  1/13.8/14.8/1.5'

C4482

C5166

C51221

5-Layer tool box with 101pc tools



50235-101 1/18.2/19.2/1.9'

5-Layer tool box with 187pc tools

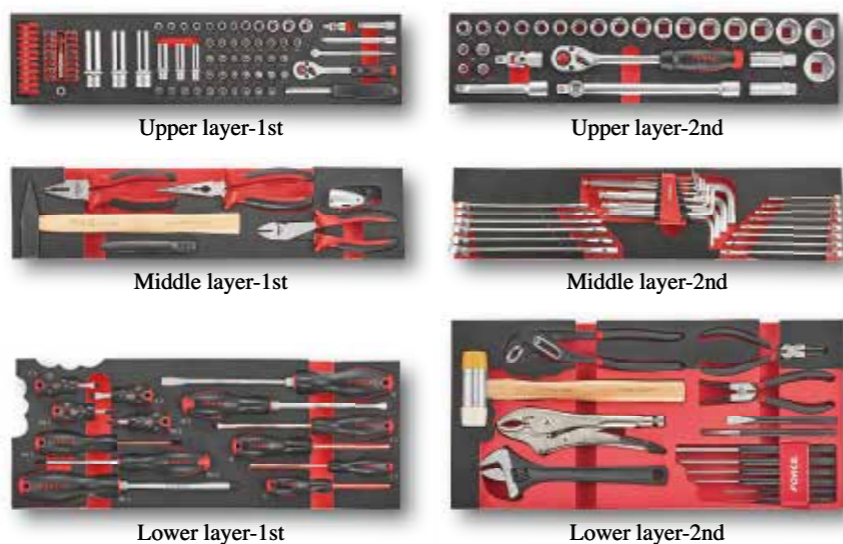

50235-187 1/20.4/21.4/1.9'

5-Layer tool box with 124pc tools (S&M)



50235-124 1/17.9/18.9/1.9'

3-Layer tool box with 25pc Insulated tools

NEW

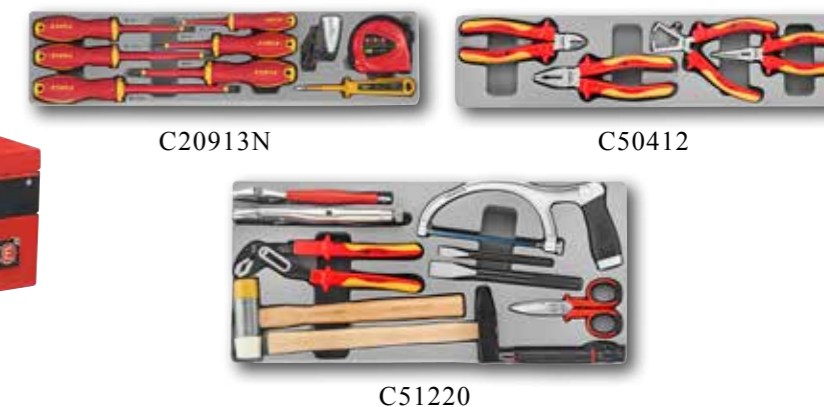

50233-25 1/10.9/11.9/1.5'

5-Layer tool box with 88pc Insulated tools

NEW

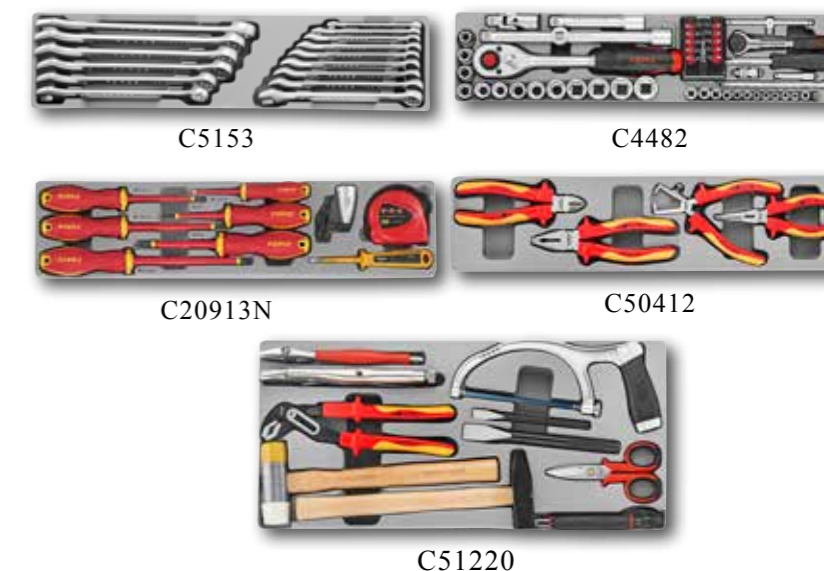

50235-88 1/18.2/19.2/1.9'

5-Layer tool box with 110pc insulated tools (S&M)

NEW



50235-110 1/18.8/19.8/1.9'

3-Drawer / 9-Drawer black tool box



50223S 1/11.5/12.5/2.2'
• L55.5 x W24 x H28 cm



50229S 1/28.2/29.2/4.3'
• L65.5 x W31 x H43 cm

Glory boxes (with glossy paint)

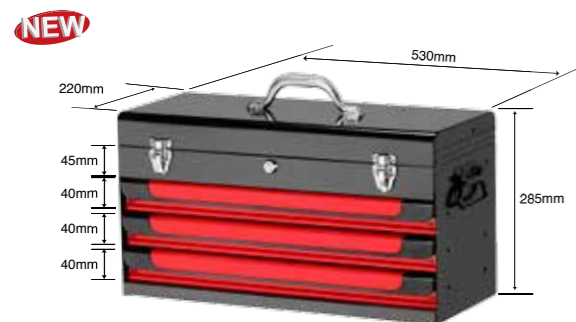

10523 1/9.8/10.6/2'



10526 1/22/25/4.8'

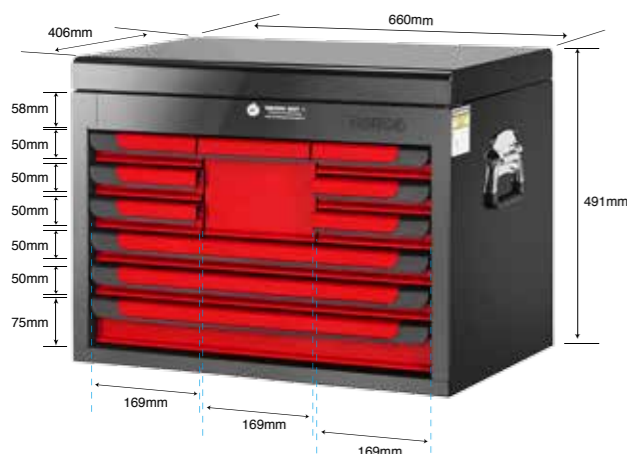

1052D 1/40/41.7/7'

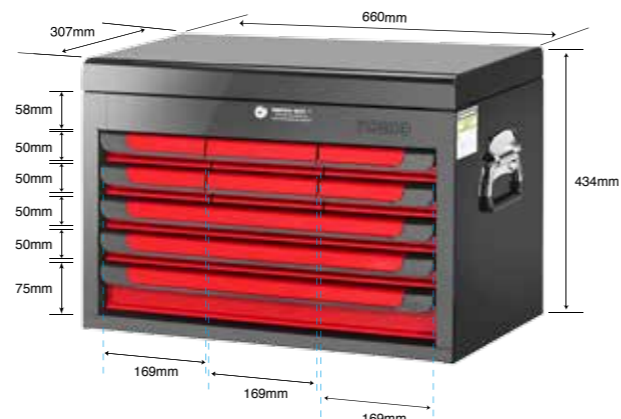

10529 1/29/32/4.8'

Basic 7-drawer trolley

NEW

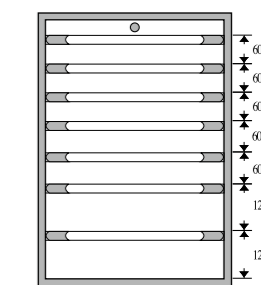
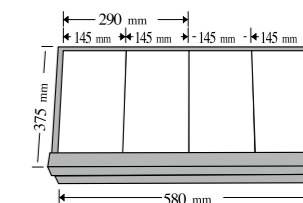

10517 1/54/58.7/14.3'
• L69 x W46.5 x H98 cm

Basic 7-drawer trolley with 310pc tools

NEW



10517-310 1/87.8/88.8/14.3'

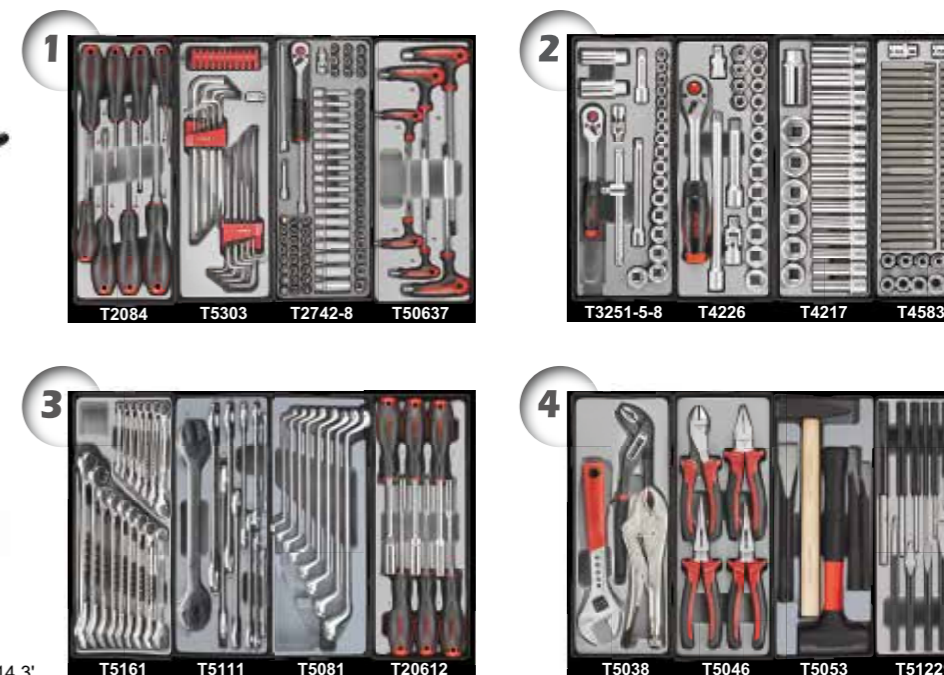



2-Drawer tool cabinet

50352  1/34.2/35.2/8.1'
 • With 15 pcs hooks included

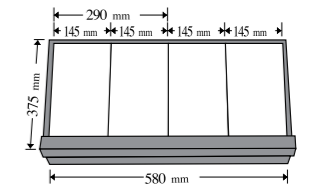

3-Drawer tool box



• L70 x W47 x H34 cm
 1/27.4/29.3/6.4'

50223



50223R

2-Drawer tool cabinet with 129pc tools



50352-129  1/46.8/48.8/9'

Heavy-duty workbench with drawers & fiberboard

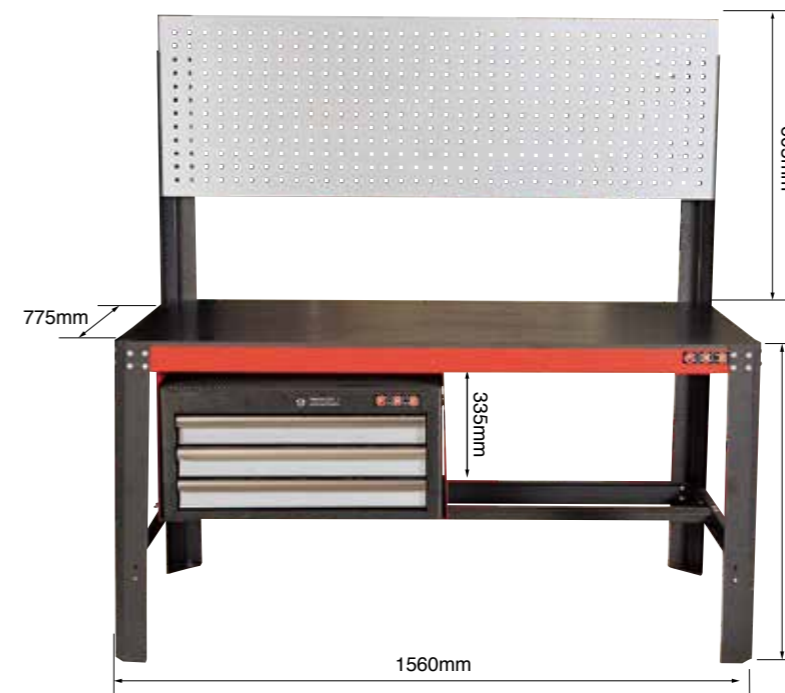

50253  1/114.4/120.6/12.1'

- With 20 pcs hooks included.
- With 3-drawer tool box 50223.

Heavy-duty workbench with drawers & lockable cabinet



50254 1/135.9/144.6/18.6'

- With 20 pcs hooks included.
- With 3-drawer tool box 50223.

Practical 5-drawer tool box

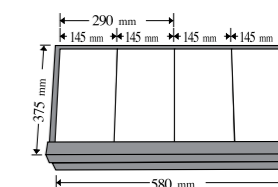

• L69 x W46 x H49 cm

1/38.7/41.9/8.9'

10225

10225B



10225A

10225R

2-Drawer service cart



50212 1/27.5/31.7/8.6'

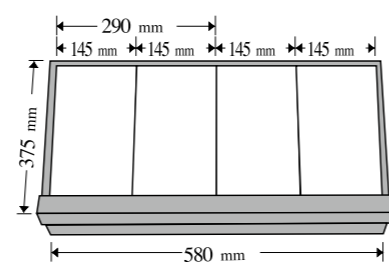

Practical 5-drawer trolley

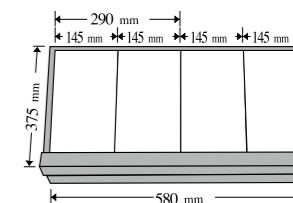

10215

10215B

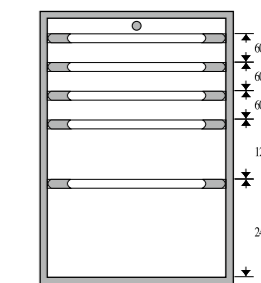

• L80 x W50 x H103 cm

1/62.6/68.19/14.8'



10215A

10215R

Practical 6-drawer trolley



Practical 7-drawer trolley



Practical 8-drawer trolley



Practical 3-drawer jumbo tool box



Practical 8-drawer jumbo trolley



10318

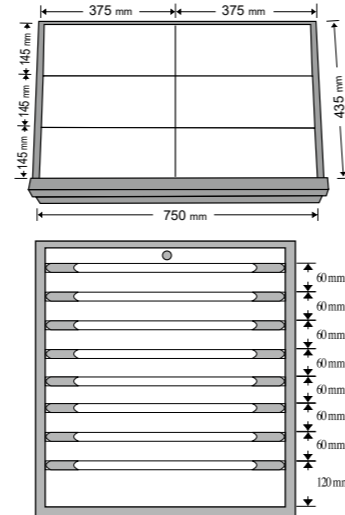

• L95 x W50 x H103 cm

1/97.7/103.2/20.2'



10318B



10318R



2pc 1/4"DR. Torque driver set



64703 40/15.7/16.7/0.5' 393g

	1pc	1-5 Nm (64721605)
	1pc	1/4"DR.x1/4"(F)

64703A 40/15.7/16.7/0.5' 393g

Changed items		
	1pc	2-8 Nm (64721608)

47pc 1/4"DR. Torque driver set



K64706 24/21.7/22.7/1.5' 905g

	4pc	1/4" PH.0; PH.1; PH.2; PH.3 (25mmL)
	4pc	1/4" PZ.0; PZ.1; PZ.2; PZ.3 (25mmL)
	5pc	1/4" 3; 4; 5; 5.5; 6.5 mm (25mmL)
	6pc	1/4" 1.5; 2; 3; 4; 5; 6 mm (25mmL)
	3pc	1/4" 1; 2; 3 mm (25mmL)
	11pc	1/4" T6; T7; T8; T9; T10; T15; T20; T25; T27; T30; T40 (25mmL)
	11pc	1/4" T-6H; T-7H; T-8H; T-9H; T-10H; T-15H; T-20H; T-25H; T-27H; T-30H; T-40H (25mmL)
	1pc	1-5 Nm (64721605)
	1pc	4"(100mm)
	1pc	1/4"DR.x1/4"(F)

K64706S 24/21.7/22.7/1.5' 905g

Changed items		
	1pc	10-50 Inch-lb (64721605S)

9pc 1/2"DR. Wheel specialized torque tool set



64707 1/12.4/13.4/0.85' 12.4kg

	3pc	44585 17C...21C	Wheel nut 6pt. flank impact socket 17; 19; 21 mm (85mmL)
	1pc	6474088N	Torque wrench 88 Nm
	1pc	6474108N	Torque wrench 108 Nm
	1pc	6474135N	Torque wrench 135 Nm
	1pc	6474163N	Torque wrench 163 Nm
	1pc	6474190N	Torque wrench 190 Nm
	1pc	681A300	Assembly wheel nut wrench 17; 19; 13/16"; 1/2"DR. (300mmL)

11pc 3/8"DR Torque wrench set



64701L 12/20.4/21.4/0.85' 1700g

	6pc	10; 12; 14; 17; 19; 21 mm
	4pc	4; 5; 6; 8 mm (50mmL)
	1pc	20-110 Nm, 380mmL (6473380)

11pc 1/2"DR Torque wrench set



64702L 6/18.1/19.1/1.1' 3016g

	6pc	17; 19; 21; 22; 24; 27 mm
	4pc	6; 8; 10; 12 mm (55mmL)
	1pc	40-210 Nm, 535mmL (6474535)

8pc Head-interchangeable torque wrench & spanner set



64709 4/15.7/16.7/0.78' 3925g

647B210	1pc	Torque wrench 40-210 Nm (14x18mm)
685C14 32...82	7pc	Single hook spanner head (14x18mm) 32; 43; 50; 60; 63.2; 72; 82 mm

10pc Head-interchangeable torque wrench & spanner set





64710 10/15.2/15.8/1.29' 1520g

647B030	1pc	Torque wrench 6-30 Nm (9x12mm)
647H209	1pc	1/4"DR. Ratchet head 24teeth (9x12mm)
68509 07...14	8pc	Spanner head (9x12mm) 7; 8; 9; 10; 11; 12; 13; 14 mm

12pc Head-interchangeable torque wrench & spanner set





64711  10/21.6/22.6/1.68'  2160g

647B110	1pc	Torque wrench 20-110 Nm (9x12mm)
647H309	1pc	3/8"DR. Ratchet head 24teeth (9x12mm)
68509 10...19	10pc	Spanner head (9x12mm) 10; 11; 12; 13; 14; 15; 16; 17; 18; 19 mm

11pc Head-interchangeable torque wrench & spanner set





64712  30/23.0/24.0/0.74'  765g

647B015	1pc	Torque wrench 3-15 Nm (9x12mm)
647H209	1pc	1/4"DR. Ratchet head 24teeth (9x12mm)
685E09	9pc	Spanner head (9x12mm)
051...069		5.1; 5.8; 6.1; 6.3; 6.4; 6.5; 6.7; 6.9 mm; 6pt. Spline

10pc Head-interchangeable torque wrench & spanner set





64713  10/15.2/16.2/1.29'  1520g

647B030W	1pc	Torque wrench 6-30 Nm (9x12mm)
647H309A	1pc	3/8"DR. Ratchet head 24teeth (9x12mm) (small, width 27mm)
68509 07...14	8pc	Spanner head (9x12mm) 7; 8; 9; 10; 11; 12; 13; 14 mm

12pc Head-interchangeable torque wrench & spanner set





64714  10/18.1/18.7/1.68'  1810g

647B060W	1pc	Torque wrench 10-60 Nm (9x12mm)
647H409	1pc	1/2"DR. Ratchet head 24teeth (9x12mm)
68509 10...19	10pc	Spanner head (9x12mm) 10; 11; 12; 13; 14; 15; 16; 17; 18; 19 mm

12pc Head-interchangeable torque wrench & spanner set





64715  10/21.6/22.4/1.68'  2160g

647B100W	1pc	Torque wrench 20-100 Nm (9x12mm)
647H409	1pc	1/2"DR. Ratchet head 24teeth (9x12mm)
68509 10...19	10pc	Spanner head (9x12mm) 10; 11; 12; 13; 14; 15; 16; 17; 18; 19 mm

8pc Head-interchangeable torque wrench & spanner set





64704  6/19.5/20.5/1.2'  3250g

647B080	1pc	Torque wrench 15-80 Nm (14x18mm)
647H414A	1pc	1/2"DR. Ratchet head 24teeth (14x18mm) (small, width 36mm)
68514 17...29	6pc	Spanner head (14x18mm) 17; 22; 24; 26; 27; 29 mm

11pc Head-interchangeable torque wrench & spanner set





64705  4/17.7/18.7/0.96'  4425g

647B210	1pc	Torque wrench 40-210 Nm (14x18mm)
647H414	1pc	1/2"DR. Ratchet head 24teeth (14x18mm)
68514 13...30	9pc	Spanner head (14x18mm) 13; 14; 15; 17; 19; 22; 24; 27; 30 mm

1/4"DR. torque driver



Part no.	Capacity		 packing	 g
	Nm			
64721602	0.4-2	100/18/18.8/1.02'		130
64721605	1-5	30/11.7/12.3/1'		280
64721608	2-8	30/13.21/13.81/1'		280
64721610	2-10	30/13.6/14/0.96'		452

3/8"DR. Preset torques wrench



Part no.	Capacity		 g
	Nm	<i>l</i> mm	
647318P	18	245	1500
647324P	24	245	1500

Tone control torques wrench



647 Part no.	Capacity Nm	Packing	l mm	g
6472270	1/4"DR. 5-25	20/15.4/16.4/1.19'	270	770
6473270	3/8"DR. 5-25	20/15.5/16.5/1.19'	270	775
6473365	20-110	20/21.5/22.5/1.46'	365	1075
6474470	1/2"DR. 42-210	12/19.8/20.8/1.1'	470	1650
6474630	70-350	10/28.7/29.7/1.4'	630	2870
6476850	3/4"DR. 65-450	4/18.1/19.1/1.7'	850	4525
64761030	140-700	4/30.3/31.3/1.67'	1030	7575
64761215	140-980	2/16.2/17.2/1.13'	1215	8100
64781215	1"DR. 140-980	2/16.3/17.3/1.13'	1215	8150
Part no.	Inch-lb	Packing	mm	g
6472270S	1/4"DR. 20-200	20/14.4/15.4/1.14'	270	720
6473270S	3/8"DR. 20-200	20/14.8/15.8/1.14'	270	740
Part no.	Ft-lb	Packing	mm	g
6473365S	3/8"DR. 5-80	20/21.0/22.0/1.14'	365	1050
6474470S	1/2"DR. 10-150	12/20.2/21.2/1.1'	470	1685
6474630S	25-250	4/11.2/12.2/0.92'	630	2800
6476850S	3/4"DR. 50-300	4/19.0/20.0/1.7'	850	4750
64761030S	100-600	4/30.0/31.0/1.67'	1030	7500
64761215S	100-700	2/15.0/16.0/0.8'	1215	7500
64781215S	1"DR. 100-700	2/15.0/16.0/0.8'	1215	7500

Spare part available

Lock torques wrench (tone control)

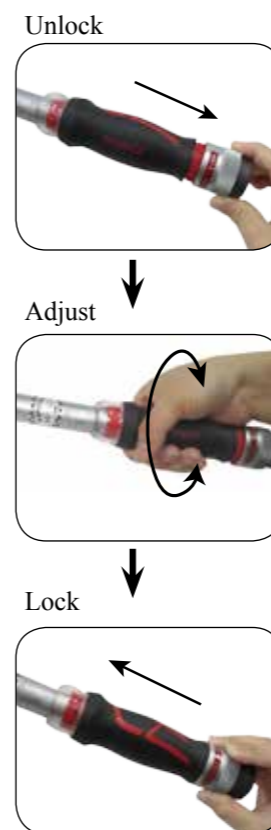

647 Part no.	Capacity Nm	Packing	l mm	g
6472295	1/4"DR. 6-30	20/19.0/20.0/1.12'	295	950
6473295	3/8"DR. 6-30	20/18.1/19.1/1.12'	295	905
6473380	20-110	12/13.7/14.7/1.57'	380	1140
6474380	1/2"DR. 20-110	12/15/16/1.3'	380	1250
6474535	40-210	10/21.0/22.0/1.31'	535	2100
6474660	70-350	6/17.9/18.9/0.92'	660	2980
6476880	3/4"DR. 100-500	4/18.7/19.7/1.07'	880	4675
64761095	140-700	4/31.0/32.0/1.93'	1095	7750
64761240	140-980	4/30.3/31.1/1.93'	1240	7575
64781240	1"DR. 140-980	2/16.2/17/1.13'	1240	8100
64781700	300-1500	1/12.0/13.0/0.9'	1700	11580
Part no.	Inch-lb	Packing	mm	g
6472295S	1/4"DR. 40-250	20/17.2/18.2/1.63'	295	860
6473295S	3/8"DR. 40-250	20/17.2/18.2/1.63'	295	860
Part no.	Ft-lb	Packing	mm	g
6473380S	3/8"DR. 15-80	8/9.1/10.1/0.76'	380	1140
6474535S	1/2"DR. 30-150	6/12.6/13.6/1.31'	535	2100
6474660S	50-250	6/17.7/18.7/0.92'	660	2950
6476880S	3/4"DR. 50-300	5/23.7/24.7/1.7'	880	4740
64761095S	100-600	4/30.0/31.0/1.8'	1095	7500
64761240S	100-700	2/16.0/17.0/1'	1240	8000
64781240S	1"DR. 100-700	2/16.0/17.0/1'	1240	8000
64781700S	200-1000	1/12.0/13.0/0.9'	1700	11580

• Spare part available

Lock torques wrench (tone control)

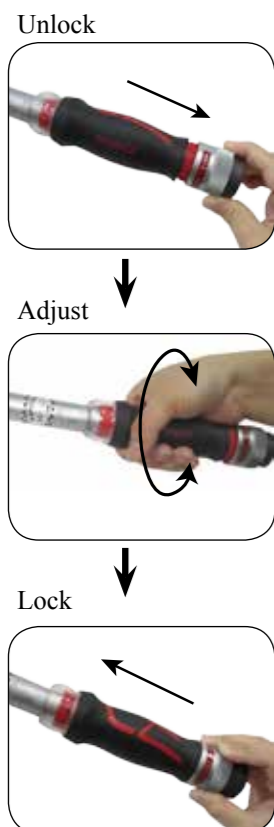

647				
Part no.	Capacity Nm	Packing	l mm	g
	3/8" DR.			
6473383	15-80	12/12.5/13.1/0.76'	383	740
6473385	20-110	12/14.0/15.0/0.76'	383	960
	1/2" DR.			
6474536	40-210	10/20.6/21.2/1.3'	535	1070
6474645	70-350	6/18.4/19.0/0.92'	645	2540
	3/4" DR.			
6476865	100-500	4/19.5/20.5/1.1'	865	3660
64761088	140-700	4/30.0/31.0/1.9'	1088	5940
64761230	140-980	2/16.0/17.0/1.1'	1230	6460
	1" DR.			
64781230	140-980	2/16.0/17.0/1.1'	1230	6460
Part no.	Capacity Ft-lb	Packing	mm	g
	3/8" DR.			
6473383S	10-60	12/12.5/13.1/0.76'	383	740
6473385S	15-80	12/14.0/15.0/0.76'	383	960
	1/2" DR.			
6474536S	30-150	10/20.6/21.2/1.3'	535	1070
6474645S	50-250	6/18.4/19.0/0.92'	645	2540
	3/4" DR.			
6476865S	50-300	4/19.5/20.5/1.1'	865	3660
64761088S	100-600	4/30.0/31.0/1.9'	1088	5940
64761230S	100-700	2/16.0/17.0/1.1'	1230	6460
	1" DR.			
64781230S	100-700	2/16.0/17.0/1.1'	1230	6460

• Spare part available



Clock wise click for right thread nut



Anti-clock wise click for left thread nut

Lock torques wrench-window display (tone control)



6472195W 30/10.2/11.2/0.74' 340g

- 1/4"DR. 3-15Nm (195mm)
- Nm in display only.

Lock torque wrench - window display (tone control)



647...W				
Part no.	Capacity	Packing	l mm	g
6472300W	1/4"DR. 6-30Nm 40-250in-lb	20/16.0/17.0/1.63'	300	800
6473420W	3/8"DR. 20-100Nm 15-75ft-lb	12/16.8/17.8/1.57'	420	1400
6474530W	1/2"DR. 40-200Nm 30-150ft-lb	10/16.0/17.0/1.31'	530	1600

• Spare part available

Lock torque wrench - window display



647...W			
Part no.	Capacity Nm	l mm	g
6472290W	1/4". DR 5-25	290	420
6473360W	3/8" DR. 10-50	360	920
6473405W NEW	20-100	405	1020
6474405W	1/2" DR. 20-100	405	1020
6474500W	40-200	500	1200
6474595W	60-300	595	1330
6474680W	80-400	680	1820
6476970W	3/4" DR. 110-550	970	3700
64761150W	150-750	1150	5600
64781250W	1" DR. 200-1000	1250	7200

• Spare part available

Double click torque wrench

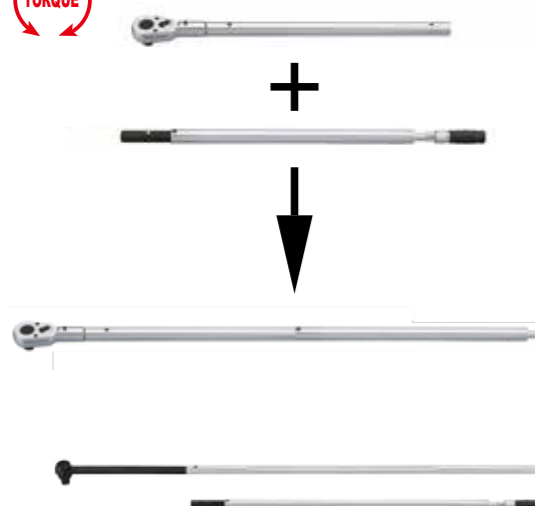

647A			<i>l</i>	
Part no.	Capacity		mm	kg
	3/4"DR.			
647A602	300-1500Nm		1720	12
647A602S	200-1000Ft-lb		1720	12
	1"DR.			
647A802	300-1500Nm		1720	12
647A802S	200-1000Ft-lb		1720	12
	1" DR.			
647A803	400-2000Nm		2176	13
647A803S	300-1500Ft-lb		2176	13
	1-1/2"DR.			
647A1201	600-3000Nm		2780	15
647A1201S	400-2000Ft-lb		2780	15



647A1201 / 647A1201S

• Spare part available



Interchangeable torque handle (Adjustable torque)



647B			Torque	<i>l</i>	
Part no.	mm		Nm	mm	g
647B005D	9x12		1-5Nm	195	340
647B030D	9x12		6-30Nm	220	420
647B110D	9x12		20-110Nm	403	970
647B210D	14x18		40-210Nm	460	1160
647B350D	14x18		70-350Nm	525	1310
647B450D	14x18		75-450Nm	775	2220

			Torque	<i>l</i>	
Part no.	mm		Nm	mm	g
647B800D	20x28.5		100-800Nm	960	5750
647B1500D	20x28.5		300-1500Nm	1786	8200

Torque handle fittings



647H
24 Teeth Ratchet head (9 X 12 mm)

Part No.	DR.
647H209	1/4"
647H309	3/8"
647H309A	3/8" (small, width 27mm)
647H409	1/2"



647H...-72
72 Teeth round ratchet head (9 X 12 mm)

Part No.	DR.
647H209-72	1/4"
647H309-72	3/8"
647H409-72	1/2"



68509
Open end wrench head (9x 12mm)

Part No.	Size (mm)
6850907	7
6850908	8
6850909	9
6850910	10
6850911	11
6850912	12
6850913	13
6850914	14
6850915	15
6850916	16
6850917	17
6850918	18
6850919	19

Torque handle fittings



685A09

Box end wrench head (9 X 12 mm)

Part No.	DR.
685A0907	7
685A0908	8
685A0910	10
685A0911	11
685A0912	12
685A0913	13
685A0914	14
685A0915	15
685A0916	16
685A0917	17
685A0918	18
685A0919	19
685A0921	21
685A0922	22

685B09

Flare nut wrench head (9 X 12 mm)

Part No.	DR.
685B0910	10
685B0911	11
685B0912	12
685B0913	13
685B0914	14
685B0916	16
685B0917	17
685B0918	18
685B0919	19
685B0921	21
685B0922	22



647H

24 Teeth Ratchet head (14 X 18 mm)

Part No.	DR.
647H314	3/8"
647H414	1/2"
647H414A	1/2" (small, width 36 mm)

Torque handle fittings



647H...-72

72 Teeth round ratchet head (14 X 18 mm)

Part No.	DR.
647H414-72	1/2"
647H314-72	3/8"



68514

Open end wrench head (14 X 18 mm)

Part No.	Size (mm)	Part No.	Size (mm)
6851413	13	6851429	29
6851414	14	6851430	30
6851415	15	6851432	32
6851416	16	6851434	34
6851417	17	6851436	36
6851418	18	6851438	38
6851419	19	6851440	40
6851421	21	6851441	41
6851422	22	6851442	42
6851424	24	6851444	44
6851426	26	6851446	46
6851427	27		

685A14

Box end wrench head (14 X 18 mm)

Part No.	Size (mm)	Part No.	Size (mm)
685A1413	13	685A1427	27
685A1414	14	685A1429	29
685A1415	15	685A1430	30
685A1416	16	685A1432	32
685A1417	17	685A1434	34
685A1418	18	685A1436	36
685A1419	19	685A1438	38
685A1421	21	685A1440	40
685A1422	22	685A1441	41
685A1424	24	685A1442	42
685A1426	26	685A1444	44
		685A1446	46



Torque handle fittings



685C14
Single hook spanner head (14 X 18 mm)

Part No.	Size (mm)
685C1432	32±5mm (strong type)
685C1443	43±5mm
685C1450	50±5mm
685C1460	60±5mm
685C1463	63.2±5mm
685C1472	72±5mm
685C1482	82±5mm



685D14
Double hook spanner head (14 X 18 mm)

Part No.	Size (mm)
685D1432	31.6±5mm
685D1435	34.9±5mm
685D1442	41.9±5mm
685D1450	50±5mm
685D1463	62.9±5mm



68520
Open end wrench head (20 x 28.5 mm)

Part No.	Size (mm)
6852032	32
6852036	36
6852041	41
6852046	46
6852050	50
6852055	55
6852060	60
6852065	65



685A20
Box end wrench head (20 x 28.5 mm)

Part No.	Size (mm)
685A2050	50
685A2055	55
685A2060	60
685A2065	65

Open ended pre-set torque wrench



Part no.	Spanner size	Torque	<i>l</i>	
	mm	Nm	mm	g
647C1817	17	18	220	410
647C4222	22	42	230	450
647C5526	26	55	290	600
647C6529	29	65	295	620

Pipe torque wrench



Part no.	Torque	<i>l</i>	
	Nm	mm	kg
647P210	40-210	590	3
647P350	70-350	825	3.7
647P500	100-500	920	4.3

• Accuracy : +-6%

Mechanical torque multipliers



65101 / 65102

Part no.	Max. Output	Square Drive	Ratio
	Nm / Ft-lb	size	
65101	1500/1100	1/2" to 3/4"	1:3
65102	3000/2200	3/4" to 1"	1:3

Part no.	Max. Input		
	Nm / Ft-lb	Packing	g
65101	500/365	4/14.4/15.4/0.75'	3600
65102	1000/730	4/19.4/20.4/1'	4850

- Spare part available
- Impact use is prohibited
- **65101L / 65102L**: Supplied with the reaction bar styles for maximum versatility.

Torque multiplier



65103 / 65104

Part no.	Drive	Ratio	Max Output		g
			Nm / Ft-lb	Nm / Ft-lb	
65103	1/2"(F)x3/4"(M)	1:10	150/110	1500/1100	3400
65104	1/2"(F)x1-1/2"(M)	1:10	400/290	4000/2900	16000

- Impact use is prohibited

Mechanical Torque Multipliers



65106 / 65107

Part no.	Drive	Torque Ratio	Max. output		g
			Max. input	Max. output	
65106	1/2"(F)x3/4"(M)	1:5	260Nm	1300Nm	8.8kg
65107	3/4"(F)x1"(M)	1:5	540Nm	2700Nm	8.7kg

- Material: SCM440 (4140)
- Finish: Manganese phosphate

Torque multiplier set



65111L

3/10.5/11.5/1.2' 3500g

- Always apply the break-away adapter in order to protect the torque multiplier from damage.
- The break-away adapter is expendable.

Contents:

- 2pc Torque multiplier head & 380mm reaction bar
1/2"(F)x3/4"(M) Max Output 1500 Nm (65111)
- 1pc 90° Reaction bar (65111L-1)
- 1pc 90° Reaction base (65111L-2)
- 1pc Break-away adapter (65111L-3)

Torque multiplier set



65112L

3/10.5/11.5/1.2' 3500g

- Always apply the break-away adapter in order to protect the torque multiplier from damage.
- The break-away adapter is expendable.

Contents:

- 2pc Torque multiplier head & 380mm reaction bar
1/2"(F)x1"(M) Max Output 2000 Nm (65112)
- 1pc 90° Reaction bar (65112L-1)
- 1pc 90° Reaction base (65112L-2)
- 1pc Break-away adapter (65112L-3)

Torque multiplier set



65113L

3/10.5/11.5/1.2' 3500g



- Always apply the break-away adapter in order to protect the torque multiplier from damage.
- The break-away adapter is expendable.



Contents:

- 2pc Torque multiplier head & 380mm reaction bar
3/4"(F)x1"(M) Max Output 2500 Nm (65113)
- 1pc 90° Reaction bar (65113L-1)
- 1pc 90° Reaction base (65113L-2)
- 1pc Break-away adapter (65113L-3)

3pc Pliers set









5034  6/10.0/11.0/0.9'  1660g

	1pc	610200	Long nose pliers 8"(200mm)
	1pc	611215	Combination pliers 8.5"(215mm)
	1pc	612175	Diagonal pliers 7"(175mm)

4pc Pliers set









5045  6/9.9/10.9/0.9'  1650g

	1pc	610B200	Long nose pliers 8"(200mm)
	1pc	611B175	Combination pliers 7"(175mm)
	1pc	612B175	Diagonal pliers 7"(175mm)
	1pc	673B215	Slip joint pliers 8.5"(215mm)

4pc Pliers set









5046  6/9.9/10.9/0.9'  1650g

	1pc	610B200	Long nose pliers 8"(200mm)
	1pc	610B200B	Bent long nose pliers 8"(200mm)
	1pc	611B175	Combination pliers 7"(175mm)
	1pc	612B175	Diagonal pliers 7"(175mm)

4pc Pliers set









5047  6/11.8/12.8/0.9'  1970g

	1pc	5047P1	Long nose straight pliers 11"(280mm)
	1pc	5047P2	Long nose 45° pliers 11"(280mm)
	1pc	5047P3	Long nose 90° pliers 11"(280mm)
	1pc	5047P4	Multi-purpose 4 points gripping pliers 11"(280mm)

4pc Snap ring pliers set





5043A  6/9.5/10.5/0.9'  1800g







	1pc	609ASO	External straight 7"(180mm)
	1pc	609ASC	Internal straight 7"(180mm)
	1pc	609ABO	External 90° bent 7"(180mm)
	1pc	609ABC	Internal 90° bent 7"(180mm)

6pc Snap ring pliers set

NEW













50653  10/16.2/17.2/1.3'  1620g

	1pc	609ASO	External straight 7"(180mm)
	1pc	60909ASO	External straight 9"(230mm)
	1pc	609ASC	Internal straight 7"(180mm)
	1pc	60909ASC	Internal straight 9"(230mm)
	1pc	609ABO	External 90° bent 7"(180mm)
	1pc	609ABC	Internal 90° bent 7"(180mm)

8pc Mini pliers set





50814  6/8.4/9.4/0.9'  1400g



	1pc	50814P1	Round nose pliers 5"(125mm)
	1pc	50814P2	Flat nose pliers 5"(125mm)
	1pc	50814P3	Combination pliers 5"(125mm)
	1pc	50814P4	Long nose pliers 5"(125mm)
	1pc	50814P5	Needle nose pliers 6"(150mm)
	1pc	50814P6	Bent nose pliers 6"(150mm)
	1pc	50814P7	Cutter pliers 6"(150mm)
	1pc	50814P8	Diagonal pliers 6"(150mm)

3pc Locking pliers set

NEW











50311  20/24.0/25.0/1'  1200g

	1pc	614125	Locking pliers 5"(125mm)
	1pc	614175	Locking pliers 7"(175mm)
	1pc	614250	Locking pliers 10"(250mm)

7pc Locking pliers & clamp set







50721  3/14.0/15.0/1.5'  4650g

	1pc	614125	Locking pliers 5"(125mm)
	1pc	614250	Locking pliers 10"(250mm)
	1pc	614A175	Locking pliers (straight jaw) 7"(175mm)
	1pc	615150	Long nose locking pliers 6"(150mm)
	1pc	66011	Locking "C" clamp 11" (275mm)
	1pc	66101	Sheet metal tool 8"(200mm)
	1pc	66201	Welding clamp 9" (225mm)

3pc Adjustable gauged wrench set







5036  6/13.3/14.3/0.9'  2210g

	1pc	649200	Adjustable gauged wrench 8"(200mm)
	1pc	649250	Adjustable gauged wrench 10"(250mm)
	1pc	649300	Adjustable gauged wrench 12"(300mm)

3pc Adjustable gauged wrench set







5036A  6/12.2/13.2/0.9'  2040g

	1pc	649200A	Adjustable gauged wrench 8"(200mm)
	1pc	649250A	Adjustable gauged wrench 10"(250mm)
	1pc	649300A	Adjustable gauged wrench 12"(300mm)

3pc Adjustable gauged wrench set







5036E  6/12.2/13.2/0.9'  2040g

	1pc	649200E	Adjustable gauged wrench 8"(200mm)
	1pc	649250E	Adjustable gauged wrench 10"(250mm)
	1pc	649300E	Adjustable gauged wrench 12"(300mm)

3pc Adjustable gauged wrench set







5036C  10/14.9/15.9/0.8'  1455g

	1pc	649200	Adjustable gauged wrench 8"(200mm)
	1pc	649250	Adjustable gauged wrench 10"(250mm)
	1pc	649300	Adjustable gauged wrench 12"(300mm)

2pc Pliers set







5021  6/10.5/11.5/0.9'  1750g

	1pc	613250	Waterpump pliers 10"(250mm)
	1pc	614250	Locking pliers 10"(250mm)

3pc Pliers set



5038  6/12.8/13.8/0.9'  2130g

	1pc	613B250	Waterpump pliers 10"(250mm)
	1pc	614250	Locking pliers 10"(250mm)
	1pc	649250A	Adjustable gauged wrench 10"(250mm)

Mini nose pliers



610110		<i>l</i>	
Part no.	packing	mm	g
610110	120/9.6/10.6/2.4'	140	80

Long nose pliers



610		<i>l</i>	
Part no.	packing	mm	g
610150	60/9.7/10.7/1'	150-6"	162
610200	60/15.5/16.5/1.4'	200-8"	258

Long nose pliers



610B		<i>l</i>	
Part no.	packing	mm	g
610B145	50/8.0/9.0/1.2'	145-5.7"	160
610B160	50/9.3/10.3/1.2'	160-6.3"	186
610B200	50/11.0/12.0/2'	200-8"	220

Bent long nose pliers



610B...B		<i>l</i>	
Part no.	packing	mm	g
610B150B	50/9.3/10.3/1.1'	150-6"	186
610B200B	50/11.0/12.0/1.9'	200-8"	220

Combination pliers



611		<i>l</i>	
Part no.	packing	mm	g
611150	60/12.6/13.6/0.9'	150-6"	210
611175	60/16.8/17.8/1.6'	175-7"	280
611215	50/20.6/21.6/1.2'	215-8.5"	412

Combination pliers



611B		<i>l</i>	
Part no.	packing	mm	g
611B160	60/15.7/16.7/1.5'	160-6.3"	261
611B175	60/16.8/17.8/2'	175-7"	280
611B200	60/22.8/23.8/1.8'	200-8"	380

Mini diagonal pliers



612140		<i>l</i>	
Part no.	packing	mm	g
612140	120/9.2/10.2/2.4'	118	77

Diagonal pliers



612175		<i>l</i>	
Part no.	packing	mm	g
612175	60/14.2/15.2/1.3'	175-7"	245



Diagonal pliers



612B		<i>l</i>	
Part no.	packing	mm	g
612B160	60/14.3/15.3/1.6'	160-6.3"	238
612B175	60/15.6/16.6/2'	175-7"	260
612B200 <small>NEW</small>	60/20.2/21.2/2'	200-8"	288



Waterpump pliers



613		<i>l</i>	
Part no.	packing	mm	g
613200	60/13.5/14.5/1.5'	200-8"	225
613250	50/23.7/24.7/1.6'	250-10"	470
613300	20/18.8/19.8/1.1'	300-12"	680
613410	12/15.6/16.6/0.5'	410-16"	1300

Heavy duty waterpump pliers



613A500		<i>l</i>	
Part no.	packing	mm	g
613A500	10/17/18/1.54'	500	1700



Waterpump pliers



613B250		<i>l</i>	
Part no.	packing	mm	g
613B250	50/20.5/21.5/1.7'	250-10"	410



Slip joint pliers



673B		<i>l</i>	
Part no.	packing	mm	g
673B160	60/14.3/15.3/1.2'	160-6.3"	238
673B215	60/16.5/17.5/2'	215-8.5"	275
673B250	60/20.4/21.4/2'	250-10"	340



Long nose straight long pliers



5047P1		<i>l</i>		
Part no.	packing	mm	g	pc/box
5047P1	50/16.5/17.5/0.64'	280-11"	330	5
5047P1L	50/17.5/18.5/0.83'	400-15.7"	480	5



Long nose 45° long pliers



5047P2		<i>l</i>		
Part no.	packing	mm	g	pc/box
5047P2	50/16.5/17.5/0.64'	280-11"	330	5
5047P2L	50/17.5/18.5/ 1.1'	400-15.7"	480	5



Long nose 90° long pliers



5047P3		<i>l</i>		
Part no.	packing	mm	g	pc/box
5047P3	50/16.5/17.5/0.64'	280-11"	330	5
5047P3L	50/17.5/18.5/1.1'	400-15.7"	480	5

Multi-purpose 4 points gripping pliers



5047P4		<i>l</i>		
Part no.	packing	mm	g	pc/box
5047P4	50/16.5/17.5/0.64'	280-11"	330	5

Snap ring pliers (internal 90° bent tip)



609...ABC	Capacity	Tip		<i>l</i>	
Part no.	mm	mm	packing	mm	g
60905ABC	8-25	1.3	30/2.4/3.4/0.38'	40-5.5"	80
609ABC	19-60	1.9	30/4.5/5.5/0.69'	180-7"	150
60909ABC	40-100	2.3	30/9.0/11.0/1.2'	230-9"	300
60912ABC	85-165	3.2	25/11.6/12.6/1.2'	310-12"	465

• 60912ABC is without a spring.

Snap ring pliers (external 90° bent tip)



609...ABO	Capacity	Tip		<i>l</i>	
Part no.	mm	mm	packing	mm	g
60905ABO	8-25	1.3	30/2.4/3.4/0.38'	140-5.5"	80
609ABO	19-60	1.9	30/4.5/5.5/0.69'	180-7"	150
60909ABO	40-100	2.3	30/9.0/11.0/1.2'	230-9"	300
60912ABO	85-165	3.2	25/12.8/13.8/1.2'	310-12"	510

Snap ring pliers (internal straight tip)



609...ASC	Capacity	Tip		<i>l</i>	
Part no.	mm	mm	packing	mm	g
60905ASC	8-25	1.3	30/2.4/3.4/0.38'	140-5.5"	80
609ASC	19-60	1.9	30/4.5/5.5/0.69'	180-7"	150
60909ASC	40-100	2.3	30/9.0/11.0/1.2'	230-9"	300
60912ASC	85-165	3.2	25/11.7/12.7/1.2'	310-12"	470

• 60912ASC is without a spring

Snap ring pliers (external straight tip)



609...ASO	Capacity	Tip		<i>l</i>	
Part no.	mm	mm	packing	mm	g
60905ASO	8-25	1.3	30/2.4/3.4/0.38'	140-5.5"	80
609ASO	19-60	1.9	30/4.5/5.5/0.69'	180-7"	150
60909ASO	40-100	2.3	30/9.0/11.0/1.2'	230-9"	300
60912ASO	85-165	3.2	25/12.3/13.3/0.88'	310-12"	490

4-in-1 Electrical pliers



6921160		<i>l</i>	
Part no.	packing	mm	g
6921160	60/9.6/10.6/1.2'	160-6"	160

Diagonal cutting pliers



6922160		<i>l</i>	
Part no.	packing	mm	g
6922160	60/12.0/13.0/1.6'	160-6"	200

Cable cutter



6923		<i>l</i>	
Part no.	packing	mm	g
6923160	60/9.6/10.6/1.6'	160	180
6923200	60/18.0/19.0/1.6'	200	300

Cable cutter



6924250		<i>l</i>	
Part no.	packing	mm	g
6924250	40/21.2/22.2/0.9'	250	530

Plastic cutting pliers



6925		<i>l</i>	
Part no.	packing	mm	g
6925160	60/8.4/9.4/1.3'	160	140
6925180	60/10.8/11.8/1.5'	180	180

Wire twisting pliers



6958		<i>l</i>	
Part no.	Packing	mm	g
6958160	80/19.0/20.0/1.1'	160	220
6958225	60/22.1/23.1/1.1'	225	360

Wire rope cutter



6959180		<i>l</i>	
Part no.	Packing	mm	g
6959180	60/17.0/18.0/1.1'	180	280

End cutting nippers



6976200		<i>l</i>	
Part no.	Packing	mm	g
6976200	50/17.5/18.5/1.4'	200	310

Steel wire rope cutter



6927310		20/14/15.5/1.4'		700g
<ul style="list-style-type: none"> • For cutting steel wire rope up to 7mm and mild steel rod up to 5mm. • For cutting copper and aluminum cable up to 60 mm². • Length:310 mm. 				

Steel wire rope cutter



6927600		10/17/20.5/2.2'		1700g
<ul style="list-style-type: none"> • For cutting steel wire rope up to 14mm and mild steel rod up to 9 mm. • For cutting copper and aluminum cable up to 150 mm². • Length:600 mm. 				

Bolt cutter



9U0501		<i>l</i>	
Part no.	packing	mm	g
9U050112	20/16.6/17.6/2.1'	300-12"	830
9U050114	20/24.0/25.0/1.9'	355-14"	1200
9U050118	15/24.2/25.2/2.3'	455-18"	1613
9U050124	8/19.0/20.0/2.7'	610-24"	2375
9U050130	6/23.8/24.8/2.1'	762-30"	3967
9U050136	5/30.4/31.4/1.8'	863-36"	6080
9U050142	3/28.0/29.0/2'	1066-42"	9330

Pipe gripping pliers



6957240		<i>l</i>	
Part no.	Packing	mm	g
6957240	40/20.0/21.0/2'	240	500

Hoof nipper



6961300		<i>l</i>	
Part no.	packing	mm	g
6961300	20/17.4/18.4/0.56'	300-12"	900

Trim pliers



6962350		<i>l</i>	
Part no.	packing	mm	g
6962350	20/21.4/22.4/0.8'	350-14"	1070

Crocodile pliers



6963330		<i>l</i>	
Part no.	packing	mm	g
6963330	20/14.2/15.2/0.8'	330-13"	710

Fence pliers



6964			
Part no.	packing	mm	g
6964260	40/20.0/21.0/1'	260-10"	500
6964310	20/14.8/15.8/0.8'	310-12"	740

Fencing tool



6965265			
Part no.	packing	mm	g
6965265	20/14.1/15.1/0.64'	265-10"	703

Tower pincers



6971			
Part no.	packing	mm	g
6971230	40/16.8/17.8/0.6'	230	420
6971250	40/19.2/20.2/1.2'	250	480
6971280	30/15.9/16.9/0.9'	280	530

Carpenter's pincers



6972180			
Part no.	packing	mm	g
6972180	60/18.9/19.9/1.2'	180	315

Locking pliers



614			
Part no.	packing	mm	g
614125	40/7.6/8.6/0.7'	125-5"	190
614175	40/14.8/15.8/0.96'	175-7"	370
614250	40/22.0/23.0/1'	250-10"	550

Locking pliers (straight jaw)



614A			
Part no.	packing	mm	g
614A175	40/16.4/17.4/0.96'	175-7"	380
614A250	40/23.2/24.2/1.0'	250-10"	580

Locking pliers (V-jaw)



614B225			
Part no.	packing	mm	g
614B225	40/23.0/24.0/1'	225-9"	575

Long nose locking pliers



615			
Part no.	packing	mm	g
615150	50/10.3/11.3/1.1'	150-6"	220
615225	50/19.5/20.5/1.2'	225-9"	390

Hose clamp pliers



Part no.	packing	l mm	g
6252807	40/10.4/11.4/0.96'	180	260
6252809	40/13.5/14.5/1'	230	338

Locking pinch-off pliers



Part no.	packing	l mm	g
9G0115	36/17.1/18.1/1.5'	280	475

Chain locking pliers



Part no.	packing	l mm	g
61901A	20/16.5/17.5/1.1'		825g

- Cr-Mo jaw and handle
- Welded with a 18" chain

Adjustable locking pliers



Part no.	packing	l mm	g
65202	50/20/21/1'	215	400

- Jaw opening : 3-46mm
- For clamping plumbing and worn screws
- Can be adjusted for clamping small to large screws
- Smooth and fast screw clamping and releasing
- Material: Jaw Cr-Mo; Body: Cr-Mo

Locking "C" clamp with easy release



Part no.	packing	l size	g
66006	42/16.6/17.6/0.67'	6"	236
66011	30/22.5/23.5/1.2'	11"	750
66018	20/21.6/22.6/1.1'	18"	1200
66024	20/23/24/1.5'	24"	1150

Locking "C" clamp with pad



Part no.	packing	l size	g
66006D	72/17.5/18.5/0.67'	6"	245
66011D	36/23.2/24.2/1.2'	11"	772
66018D	20/23.5/24.5/1.1'	18"	1175
66024D	16/23.1/24.1/1.6'	24"	1438

Sheet metal tool



Part no.	packing	l mm	g
66101	48/22.0/23.0/1.2'		458g

- Size: 8"
- Cr-mo jaws
- Bodily heat-treated
- Welding brazed
- Nickel plated
- Function: U-shaped jaws allow access and perfect visibility when welding.

Welding clamp



Part no.	packing	l mm	g
66201	40/24.8/25.8/1.4'		620g

- Size: 9"
- Cr-mo jaws
- Bodily heat-treated
- Welding brazed
- Nickel plated
- Function: clips things by the two flat pieces in front of the clamp.

Adjustable gauged wrench



649	size		<i>l</i>	
Part no.	mm	packing	mm	g
649150	20	100/17.0/18.0/1.6'	150	122
649200	24	60/17.4/18.4/2.1'	200	242
649250	29	30/15.0/16.0/1.5'	250	397
649300	34	20/15.3/16.3/1.2'	300	605
649375	43	12/15.6/16.6/1.3'	375	1140
649450	53	10/19.0/20.0/0.7'	450	1610
649600	62	6/19.7/20.7/1.2'	600	3280

Adjustable gauged wrench (left-threaded)

NEW



649...L	size		<i>l</i>	
Part no.	mm	packing	mm	g
649150L	20	100/13.4/14.4/1.4'	150	134
649200L	24	60/14.4/15.4/1.1'	200	240
649250L	29	30/12.7/13.7/0.96'	250	424
649300L	33	20/13.6/14.6/0.87'	300	681
649375L	43	12/15.6/16.6/1'	375	1300
649450L	60	10/17.6/18.6/0.7'	450	1760

Adjustable gauged wrench



649...A	size		<i>l</i>	
Part no.	mm	packing	mm	g
649100A	13	100/9.0/10.0/1.4'	100	55
649150A	19	100/14.0/15.0/1.2'	150	135
649200A	24	50/13.0/14.0/1'	200	245
649250A	29	30/12.7/13.7/0.77'	250	440
649300A	34	20/15.3/16.3/1.2'	300	700
649375A	43	12/14.3/15.3/0.9'	375	1250

Adjustable gauged wrench(left-threaded)



649...AL	Size		<i>l</i>	
Part No.	mm	Packing	mm	g
649100AL	13	100/9.0/10.0/1.4'	100	55
649150AL	19	100/14.0/15.0/1.2'	150	135
649200AL	24	50/13.0/14.0/1'	200	245
649250AL	29	30/12.7/13.7/0.77'	250	440
649300AL	34	20/15.3/16.3/1.2'	300	700
649375AL	43	12/14.3/15.3/0.9'	375	1250

Adjustable gauged wrench



649...E	size		<i>l</i>	
Part no.	mm	packing	mm	g
649200E	24	60/18.0/19.0/2.1'	200	290
649250E	29	30/15.0/16.0/1.5'	250	500
649300E	33	20/15.3/16.3/1.3'	300	765

Wide-jaw adjustable wrench



649200C		<i>l</i>	
Part no.	Packing	mm	g
649200C	50/16.0/17.0/1'	200	280

- Material : Chrome Vanadium
- Type : Screw pin w/front side metric scale.
- Hot Forged Handle and Jaw
- Whole piece with heat treatment
- Perfectly matched knurl and teeth of jaw for smooth running
- Exceed world-wide industrial standard specification
- Over standard jaw opening, approach 38mm
- TPR handle w/end hole button

Ratchet-function adjustable wrench



649200D		<i>l</i>	
Part no.	Packing	mm	g
649200D	40/10.8/11.8/1'	200	270

- Material: Chrome Vanadium
- Patented ratchet-function jaw
- Comfortable and strong TPR handle

86pc Grade nut fastener set



5861

6/5.8/6.8/0.9' 960g

67802	1pc	Grade nut fastener (include 1pc M6x1.0 screw)
5861-M3...M5	3pc	M3x0.5; M4x0.7; M5x0.8
5861-S	1pc	Spanner
5861-1	20pc	Instant blind nut 5.1mm
5861-2	20pc	Instant blind nut 6.1mm
5861-3	20pc	Instant blind nut 7.1mm
5861-4	20pc	Instant blind nut 9.1mm

181pc Rivet pliers set



T51811

6/8.2/9.2/0.73' 1360g

67801	1pc	Rivet pliers
51811-1	30pc	Aluminum rivet 4x8
51811-2	30pc	Aluminum rivet 4x10
51811-3	30pc	Aluminum rivet 4.8x8
51811-4	30pc	Aluminum rivet 4.8x10
51811-5	30pc	Stainless rivet 4x7
51811-6	30pc	Stainless rivet 4x10

Rivet pliers



67801

Part no.	packing	mm	g
67801	20/15.7/16.7/2.1'	180	785

• Riveting capacity

Rivet diameter	Rivet material	
	Aluminum	Stainless Steel/Inox
Ø2.4mm or Ø3/32"	▲	●
Ø3.0/3.2mm or Ø1/8"	▲	●
Ø4.0mm or Ø5/32"	▲	●
Ø4.8/5.0mm or Ø3/16"	▲	●

Grade nut fastener



67802

Part no.	packing	mm	g
67802	20/12.6/13.6/1.5'	280	630

- M6 nozzle included.
- M3, M4, M5 are optional: (5861-M3, 5861-M4, 5861-M5)

Hand riveter



678260

30/17.3/18.3/1.5' 556g

- Rivet size: Ø2.4mm (Ø3/32"); Ø3.0, 3.2mm (Ø1/8"); Ø4.0mm (Ø5/32"); Ø4.8, 5.0mm (Ø3/16")
- High-grade heavy-duty steel plate upper handle with advanced heat treatment, high-strength aluminum body, high-grade steel alloy key parts (jaws, jaw case, fulcrum pin, etc) with advanced heat treatment, PAHs-Free (non-toxic to hand skin) plastic hand grips.

• Riveting capacity

Rivet diameter	Rivet material		
	Aluminum	Steel	Stainless Steel/Inox
Ø2.4mm or Ø3/32"	▲	■	●
Ø3.0/3.2mm or Ø1/8"	▲	■	●
Ø4.0mm or Ø5/32"	▲	■	●
Ø4.8/5.0mm or Ø3/16"	▲	■	●

Heavy-duty 2-handled lever type riveter

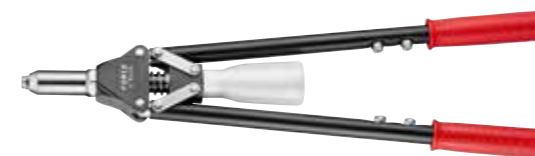

678535

10/17.5/18.5/1.6' 1890g

- Cap: Ø3.0mm ~ Ø6.4mm
- Blind rivets: Ø1/8"~ Ø1/4"

• Riveting capacity

Rivet diameter	Rivet material		
	Aluminum	Steel	Stainless Steel/Inox
Ø3.0/3.2mm or Ø1/8"	▲	■	●
Ø4.0mm or Ø5/32"	▲	■	●
Ø4.8/5.0mm or Ø3/16"	▲	■	●
Ø6.0mm	▲	■	●
Ø6.4mm or Ø1/4"	▲	■	●

Heavy-duty lazy tong type riveter

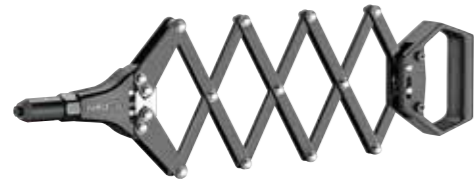

678810

10/19.5/20.5/1.4' 1845g

- Cap: Ø3.0mm ~ Ø6.4mm
- Blind rivets: Ø1/8" ~ Ø1/4"

Riveting capacity

Rivet diameter	Rivet material		
	Aluminum	Steel	Stainless Steel/Inox
Ø3.0/3.2mm or Ø1/8"	▲	■	●
Ø4.0 mm or Ø5/32"	▲	■	●
Ø4.8 / 5.0mm or Ø3/16"	▲	■	●
Ø6.0mm	▲		
Ø6.4mm or Ø1/4"	▲		

Hand nut riveter (M3~M8)



678N260

30/17.3/18.3/1.5' 640g

- With 5 short type threaded mandrels M3 ~ M8.
- With 4 nosepieces M3 ~ M6 (M8 does not need nosepiece).
- Forged steel upper handle with advanced heat treatment, high strength aluminum body with steel insert design.
- Stroke adjuster design.
- Riveting capacity

Rivet Nut Thread Size	Rivet Nut Material		
	Aluminum	Steel	Stainless Steel / Inox
M3x0.5 or 6-32 Rivet Nut	▲	■	●
M4x0.7 or 8-32 Rivet Nut	▲	■	●
M5x0.8 or 10-24, 10-32 Rivet Nut	▲	■	●
M6x1.0 or 1/4-20 Rivet Nut	▲	■	●
M8x1.25 or 5/16-18 Rivet Nut	▲		

Heavy-duty hand nut riveter (M4~M10)



678N320

10/17.5/18.5/1.6' 860g

- With 5 short type threaded mandrels M4 ~ M10 and 5 Nosepieces M4 ~ M10.
- High tension steel short handle with super leverage design, high strength aluminum bodies.
- Special design to solve the headache problem of rivet nut stuck with threaded mandrel.
- Stroke adjuster design with stroke indicator.
- Mandrel length adjustable design.
- Riveting capacity

Rivet Nut Thread Size	Rivet Nut Material		
	Aluminum	Steel	Stainless Steel / Inox
M4x0.7 or 8-32 Rivet Nut	▲	■	●
M5x0.8 or 10-24, 10-32 Rivet Nut	▲	■	●
M6x1.0 or 1/4-20 Rivet Nut	▲	■	●
M8x1.25 or 5/16-18 Rivet Nut	▲	■	
M10x1.5 or 3/8-16 Rivet Nut	▲		

10pc Tubing cutter and double flaring tool kit



656

12/18.5/19.5/1.2' 1542g

Contents:

- 1pc Flaring screw
- 1pc Tubing cutter
- 1pc 9/16" Screen bar
- 7pc Adaptor 3/16"; 1/4"; 5/16"; 3/8"; 7/16"; 1/2"; 5/8"

656M

12/18.5/19.5/1.2' 1542g

Changed items

- 7pc Adaptor 4; 6; 8; 10; 12; 14; 16 mm

10pc Tubing cutter & double flaring tool set

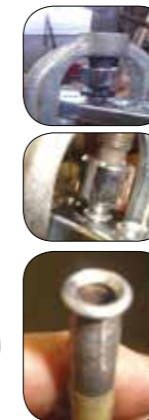

656A

10/17.3/18.3/1' 1730g

- This 2-in-1 flaring tool set is designed to withstand the high pressures necessary to double flare soft steel tubing, as well as, single flare soft copper, aluminum and brass tubing. Automotive 45°.

Contents:

- 1pc Flaring tool
- 1pc Flare bar
- 7pc Adaptor 3/16"; 1/4"; 5/16"; 3/8"; 7/16"; 1/2"; 5/8"
- 1pc Heavy duty tube cutter: 1/8"-1/18"

656AM

10/17.3/18.3/1' 1730g

Changed items

- 1pc Flare bar
- 7pc Adaptor 4; 4.75; 6; 8; 10; 12; 14 mm
- 1pc Heavy duty tube cutter: 4-28mm

7pc Double flaring tool kit



656F

10/11.0/12.0/1' 1100g

- This 45° double flaring tool is designed for S.A.E. size tubing and will withstand pressure that is necessary for double flare tubing up to 1mm wall thickness. Tool can be used as a single flaring tool

Contents:

- 1pc Flaring tool
- 1pc Flare bar
- 5pc Adaptor 3/16"; 1/4"; 5/16"; 3/8"; 1/2"

Hydraulic flaring tool kit



656B  6/15.0/16.0/1.5'  2330g

- SAE: 3/16"; 1/4"
- DIN: 3/16"; 1/4"



Hydraulic flaring tool kit



656BM  6/15.5/16.5/1.4'  2585g

- Use in-site on the vehicle and suitable for producing SAE (3/16" & 1/4") and DIN 45 degree (3/16" & 1/4") flares.
- Capable of working on steel brake pipes.
- 4.75; 5; 6 mm

Universal hydraulic flaring tool set



656B01  2/13.0/14.0/1.2'  6664g

- A quality flaring tool set containing a hydraulic flaring tool capable of 6 tons of pressure and a range of dies and adaptors suitable for:
 - 1) Push connect: 1/4", 5/16", 3/8", 1/2"
 - 2) GM fuel line flare: 5/16", 3/8"
 - 3) 45° & Double flare: 3/16", 1/4", 5/16", 3/8", 1/2"
 - 4) Metric bubble flare: 4.75mm, 6mm, 8mm, 10mm
 - 5) GM-TC: 3/8", 1/2"

45° Eccentric flaring tool for R410A



65641  8/12.0/13.0/1.5'  1500g

- Engineered to create stronger flare joints for high pressure R410A systems.
- Unique clutch driven feed screw and faceted cone produce uniform, clean flare walls without thin spots or galling.
- For 45° flaring of 1/4"; 5/16"; 3/8"; 1/2"; 5/8"; 3/4" O.D. tubing.

Telescopic tubing cutter



65601  60/17.0/18.0/2.1'  283g

- Hardened cutting wheel
- Tapered burr remover
- Cuts copper, brass, aluminum & mild steel tubing 1/8" to 1-1/8" (3-29mm) outside diameter.

Mini tubing cutter



65602  100/13.5/14.5/2.2'  135g

- 1/8" to 7/8" (3-22mm) O.D. range.
- Small size allows use in restricted areas.

Professional tubing cutter





65604  60/16.8/17.8/1.8'  280g

- Solid and durable
- Aluminum alloy body
- High grade SUJ2 steel blade
- With deburring reamer
- Capacity: 4-28mm (1/8"~1-1/8")
- For copper, brass and aluminum tubing.

Telescopic tubing cutter





65608  60/17.0/18.0/2'  270g

- For 1/8"~1-1/4" (3-32mm) O.D. tube, sk-2(1+1)

Ratchet tube cutter





656	Capacityø	 packing	 g
Part no.	mm		
65631	8-28	36/16.5/17.5/2.14	392
65632	28-67	12/13/13.5/0.84	1036

- Quick and easy ratchet mechanism make it easy and comfortable to use even in narrow spaces.
- 65631 can cut copper pipe up to 1.5mm.
- 65632 can cut stainless pipe up to 3mm.

Exhaust pipe and tubing cutter





65603  30/17.6/18.6/1.1'  586g

- Cuts thin-walled steel and copper tubing from Ø20mm to Ø75mm (3/4" to 3").
- Cuts quickly and easily.
- Fitted with 7 cutting blades for fast, clean cutting.

Iron pipe cutter





65605  6/18.6/19.6/1.9'  3100g

- For 1/8"-2" (3mm-5mm) O.D. iron pipe
- Part: Cutting wheel (**65605-B**)
- 43cm

Inside / Outside deburring tool





65304  120/5.0/6.0/2.5'  35g

- 3/16"~1-1/2" O.D, plastic body.



3-in-1 Tubing bender





653	Application	 packing	 g
Part no.	size		
65301	6;8;10mm	50/17.4/18.4/2'	348
65302	1/4";5/16";3/8"	50/19.5/20.5/2'	390



180° 3-in-1 Tube bender



653180  20/10.9/11.9/2'  545g

- Quality aluminum body
- Three size tube bender
Inch: 1/4", 5/16", 3/8"
Metric: 6mm, 8mm, 10mm

Breakline bending pliers



65303  50/20.5/21.5/0.85'  420g

- Size: 3/16", 1/4"

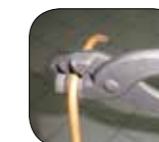

Tubing bending pliers



65305  8/20.0/21.0/0.8'  2500g

- For bending brass, copper, aluminum and steel tubing.
- Tubing bender pliers feature one roller.
- One roller accepts 3/16"; 1/4"; 5/16"; 3/8" (4.8; 6.4; 7.9; 9.5mm) O.D. tubing.

Tube straightener tool





65306  2/14.5/15.5/0.9'  6526g

- Straighten coils of brake pipe quickly and easily.
- For use on most types of tubing including soft metal tube, copper and stainless steel.
- Size ranges from 3/16" - 1/2" (4.75 - 12.7mm)



Pipe wrench



684		<i>l</i>	
Part no.	packing	mm	g
68408	36/14.0/15.0/0.4'	200-8"	390
68410	24/17.0/18.0/0.4'	250-10"	710
68412	24/23.0/24.0/0.5'	300-12"	960
68414	12/16.0/17.0/0.4'	355-14"	1340
68418	12/25.0/26.0/0.6'	455-18"	2090
68424	6/22.0/23.0/0.7"	610-24"	3670
68436	3/25.0/26.0/1.1'	863-36"	8340
68448	2/24.0/25.0/1.0'	1220-48"	12000



Aluminum pipe wrench



684...A		<i>l</i>	
Part no.	packing	mm	g
68410A	24/11.0/12.0/0.4'	250-10"	460
68412A	24/17.0/18.0/0.4'	300-12"	700
68414A	24/21.5/22.5/0.5'	355-14"	895
68418A	12/18.0/19.0/0.9'	455-18"	1500
68424A	6/14.0/15.0/0.7"	610-24"	2330
68436A	3/14.0/15.0/1.1'	863-36"	4660
68448A	2/13.0/14.0/1.0'	1220-48"	6500

Pipe wrench



684C	size	<i>l</i>		
Part no.	inch	mm	packing	g
684C14	1	350-14"	20/15.8/16.8/0.78'	790
684C17	1-1/2	440-17"	16/23.2/24.2/1.7"	1450
684C22	2	560-22"	8/18.8/19.8/1.6'	2350

Pipe torque wrench









647P	Torque	<i>l</i>	
Part no.	Nm	mm	kg
647P210	40-210	590	3
647P350	70-350	825	3.7
647P500	100-500	920	4.6

• Accuracy: +6%

5pc Chisel punch set





5054  40/20.2/21.5/1.3'  505g

	1pc	60212150	Chisel 12 (150mmL)
	1pc	603150	Cape chisel (150mmL)
	1pc	6044190	Pin punch 4 (190mmL)
	1pc	6063185	Taper punch 3 (185mmL)
	1pc	6074185	Center punch 4 (185mmL)

5pc Chisel set





50510  30/26.5/27.5/0.5'  887g

	1pc	60210150	Chisel 10 (150mmL)
	1pc	60212150	Chisel 12 (150mmL)
	1pc	60215180	Chisel 15 (180mmL)
	1pc	60219200	Chisel 19 (200mmL)
	1pc	60222200	Chisel 22 (200mmL)

6pc Pin punch set





50613  30/16.7/17.7/1.3'  540g

	1pc	6042140	Pin punch 2 (140mmL)
	1pc	6043150	Pin punch 3 (150mmL)
	1pc	6044190	Pin punch 4 (190mmL)
	1pc	6045200	Pin punch 5 (200mmL)
	1pc	6046210	Pin punch 6 (210mmL)
	1pc	6048215	Pin punch 8 (215mmL)

6pc Spring pin punch set





50614  100/23.6/24.6/0.9'  236g

	1pc	60519090	Spring pin punch 1.9 (90mmL)
	1pc	60529095	Spring pin punch 2.9 (95mmL)
	1pc	60539115	Spring pin punch 3.9 (115mmL)
	1pc	60549115	Spring pin punch 4.9 (115mmL)
	1pc	60559140	Spring pin punch 5.9 (140mmL)
	1pc	60579150	Spring pin punch 7.9 (150mmL)

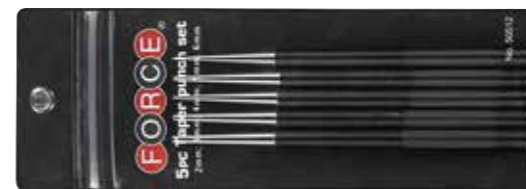
5pc Taper punch set





50512  30/14.4/15.4/0.5'  480g

	1pc	6062185	Taper punch 2 (185mmL)
	1pc	6063185	Taper punch 3 (185mmL)
	1pc	6064185	Taper punch 4 (185mmL)
	1pc	6065185	Taper punch 5 (185mmL)
	1pc	6066185	Taper punch 6 (185mmL)

5pc Center punch set





50511  30/18.8/19.8/0.5'  627g

	1pc	60725185	Center punch 2.5 (185mmL)
	1pc	6074185	Center punch 4 (185mmL)
	1pc	6076185	Center punch 6 (185mmL)
	1pc	6078185	Center punch 8 (185mmL)
	1pc	60710185	Center punch 10 (185mmL)

7pc Long tapered punch set (10"L)





50722  10/16.7/17.7/0.62'  1670g





	1pc	606103.32	Long tapered punch 3/32" (1/4")
	1pc	606101.8	Long tapered punch 1/8" (5/16")
	1pc	606103.16	Long tapered punch 3/16" (3/8")
	1pc	606107.32	Long tapered punch 7/32" (7/16")
	1pc	606101.4	Long tapered punch 1/4" (1/2")
	1pc	606105.16	Long tapered punch 5/16" (5/8")
	1pc	606103.8	Long tapered punch 3/8" (3/4")

12pc Chisel and pin punch set

NEW

















51229  6/12.9/13.9/0.9'  2150g

	1pc	60212150	Chisel 12 (150mmL)
	1pc	60215180	Chisel 15 (180mmL)
	1pc	60222200	Chisel 22 (200mmL)
	1pc	603150	Cape chisel (150mmL)
	1pc	6042140	Pin punch 2 (140mmL)
	1pc	6043150	Pin punch 3 (150mmL)
	1pc	6044190	Pin punch 4 (190mmL)
	1pc	6045200	Pin punch 5 (200mmL)
	1pc	6046210	Pin punch 6 (210mmL)
	1pc	6048215	Pin punch 8 (215mmL)
	1pc	60410230	Pin punch 10 (230mmL)
	1pc	6074185	Center punch 4 (185mmL)

13pc Chisel and punch set









5131  6/13.0/14.0/0.9'  2167g

	1pc	60210150	Chisel 10 (150mmL)
	1pc	60212150	Chisel 12 (150mmL)
	1pc	60215180	Chisel 15 (180mmL)
	1pc	60219200	Chisel 19 (200mmL)
	1pc	60222200	Chisel 22 (200mmL)
	1pc	603150	Cape chisel (150mmL)
	1pc	6042140	Pin punch 2 (140mmL)
	1pc	6043150	Pin punch 3 (150mmL)
	1pc	6044190	Pin punch 4 (190mmL)
	1pc	6062185	Taper punch 2 (185mmL)
	1pc	6063185	Taper punch 3 (185mmL)
	1pc	6064185	Taper punch 4 (185mmL)
	1pc	6074185	Center punch 4 (185mmL)

5pc Hammer and chisel set











5053  6/14.5/15.5/0.9'  2415g

	1pc	60215180	Chisel 15 (180mmL)
	1pc	60219180	Chisel 19 (180mmL)
	1pc	60225220	Chisel 25 (220mmL)
	1pc	616300	Enginer hammer 300gw
	1pc	616400	Rubber hammer 400gw (280mmL)

6pc Hammer, chisel and punch set









T50633AF  6/13.4/14.4/0.73'  2232g

	1pc	60226200C	Ribbed chisel 26 (200mmL)
	1pc	6044190	Pin punch 4 (190mmL)
	1pc	6046210	Pin punch 6 (210mmL)
	1pc	6074185	Center punch 4 (185mmL)
	1pc	616F032	Riveting hammer 32mm
	1pc	616A400	Soft face hammer 400gw

5pc Cutting tools set





5055  6/9.5/10.5/0.9'  1583g

	1pc	5055P1	Straight shears
	2pc	5055P3	Saw blade
	1pc	5055P4	Utility knife (include 3pc blades)
	1pc	66302	Mini hacksaw frame 6"

5pc Needle file set



50513  120/10.8/11.8/0.9'  90g

- Set of 5pcs needle files with different shapes. Smooth cut.



Contents:

- 1pc Flat needle file
- 1pc Round needle file
- 1pc Half-round needle file
- 1pc Square needle file
- 1pc Triangular needle file

5pc File set



5056  6/10.2/11.2/0.9'  1690g

	1pc	5056P1	8"(200mm) Flat file
	1pc	5056P2	8"(200mm) Half-round file
	1pc	5056P3	8"(200mm) Round file
	1pc	5056P4	8"(200mm) Square file
	1pc	5056P5	8"(200mm) Triangular file

Chisel



602	Size	<i>l</i>		
Part no.	mm	mm	g	pc/box
60210150	10	150	83	10
60212150	12	150	89	10
60215180	15	180	152	10
60219200	19	200	293	10
60222200	22	200	302	5
60225220	25	220	415	5

Quakeproof and safe chisel



602...Q	Size	<i>l</i>		
Part no.	mm	mm	g	pc/box
60210150Q	10	150	100	10
60212150Q	12	150	102	10
60215180Q	15	180	168	10
60219200Q	19	200	320	5
60222200Q	22	200	327	5
60225220Q	25	220	440	5

Ribbed (Cold) chisel



602...C	Size	<i>l</i>		
Part no.	mm	mm	g	pc/box
60218125C	18	125	90	10
60221150C	21	150	155	10
60226200C	26	200	320	10
60229250C	29	250	470	10
60234300C	34	300	750	5

Ribbed (Cold) chisel with sheath handle



602...Q	Size	<i>l</i>		
Part no.	mm	mm	g	pc/box
60229250Q	29	250	540	10
60234300Q	34	300	820	5

Cape chisel



603150	<i>l</i>		
Part no.	mm	g	pc/box
603150	150	83	10

Quakeproof and safe cape chisel



603150Q	<i>l</i>		
Part no.	mm	g	pc/box
603150Q	150	100	10

Pin punch



604	size	<i>l</i>		
Part no.	mm	mm	g	pc/box
6042140	2	140	42	10
6043150	3	150	45	10
6044190	4	190	86	10
6045200	5	200	91	10
6046210	6	210	133	10
6048215	8	215	150	10
60410230	10	230	218	10
60412280	12	280	349	10
60414290	14	290	464	10
60416310	16	310	544	10

Quakeproof and safe pin punch



604...Q	size	<i>l</i>		
Part no.	mm	mm	g	pc/box
6042140Q	2	140	58	10
6043150Q	3	150	59	10
6044190Q	4	190	105	10
6045200Q	5	200	106	10
6046210Q	6	210	147	10
6048215Q	8	215	166	10
60410230Q	10	230	235	10
60412280Q	12	280	381	5
60414290Q	14	290	495	5
60416310Q	16	310	575	5

Spring pin punch



605		<i>l</i>		
Part no.	size	mm	g	pc/box
60519090	1.9	90	18	10
60529095	2.9	95	18	10
60539115	3.9	115	33	10
60549115	4.9	115	35	10
60559140	5.9	140	56	10
60579150	7.9	150	74	10

Taper punch



606		<i>l</i>		
Part no.	size	mm	g	pc/box
6062185	2	185	95	10
6063185	3	185	96	10
6064185	4	185	98	10
6065185	5	185	101	10
6066185	6	185	103	10
6068185	8	185	149	10

Quakeproof and safe taper punch



606...Q		<i>l</i>		
Part no.	size	mm	g	pc/box
6062185Q	2	185	114	10
6063185Q	3	185	115	10
6064185Q	4	185	116	10
6065185Q	5	185	119	10
6066185Q	6	185	120	10
6068185Q	8	185	166	10

Center punch



607		<i>l</i>		
Part no.	size	mm	g	pc/box
60725185	2.5	185	95	10
6074185	4	185	97	10
6076185	6	185	103	10
6078185	8	185	147	10
60710185	10	185	203	10

Quakeproof and safe center punch



607...Q		<i>l</i>		
Part no.	size	mm	g	pc/box
60725185Q	2.5	185	114	10
6074185Q	4	185	116	10
6076185Q	6	185	120	10
6078185Q	8	185	166	10
60710185Q	10	185	219	10

Engineer hammer



616		
Part no.	packing	g
616200	84/20.8/22.2/1.11'	240
616300	48/20.7/22.7/1.11'	431
616500	36/22.0/23.5/1.19'	611
6161000	16/20.0/21.3/0.91'	1250
6161500	12/21.0/22.1/0.84'	1750

Ball pein hammer



616B		<i>l</i>	
Part no.	Packing	mm	g
616B08	50/17.8/18.8/1.1'	295	355
616B12	50/23.8/24.8/1.1'	295	475
616B16	40/27.0/28.0/2.5'	350	635
616B24	20/22.0/23.0/2.2'	400	1000
616B32	20/25.0/26.0/2.2'	400	1150
616B48	10/17.6/18.6/1.3'	403	1755

Riveting hammer



616F	Size		
Part no.	mm	Packing	g
616F032	32	36/23.5/24.9/1.06'	600
616F035	35	24/19.4/20.5/0.85'	760
616F040	40	24/25.5/26.8/1.04'	1040

- Head material: 1055 medium carbon steel
- Head polished: matt baked painted finished, striking face and end polished.
- Handle: Natural color hickory handle with laser "GENUINE HICKORY"



Sledge hammers



616G	Head weight	Total length	
Part no.	g	mm	packing
616G1250	1250	260	16/22.6/23.6/0.68'
616G1500	1500	280	12/21.6/22.4/0.59'

Rubber hammer



616		<i>l</i>	
Part no.	packing	mm	g
616260	72/25.0/27.0/1.71'	262	350
616400	48/26.0/28.0/1.62'	280	520
616580	36/25.0/27.0/1.61'	300	690
616810	24/23.0/25.0/1.35'	320	940

Recoilless hammer (head-replaceable)



616A	<i>l</i>	
Part no.	mm	g
616A025	25	389
616A030	30	435
616A035	35	505
616A040	40	606
616A045	45	865
616A050	50	952
616A055	55	1038
616A060	60	1125

- Steel handle with positive plastic grip.
- PU-material strike faces.
- Both strike faces can be repeatedly changed if broken.

Soft face hammer



616A400  48/19.2/20.2/1.62'  400g

- Hammer head: 1 yellow PU + 1 white Nylon
- Handle: natural color hickory

Soft face hammers



616A700  24/20.2/21.4/0.9'  700g

- Hammer head: black TPR & transparent yellow acetate head
- Handle: 1.4mm harden tubular steel handle, PVC ring & A type PVC grip

Super heavy duty hacksaw



66301  24/22.0/23.0/1.9'  916g

- Grip handle design
- Quick-change blade design
- Blade available

Mini hacksaw



66302  72/15.7/16.7/1'  218g

- Ergonomic grip handle design.
- For plastic, wood or metal.
- Blade length 150mm, overlength 270mm.
- Blade available

Hacksaw



66303  72/15.7/16.7/1'  100g

- Blade available
- Length: 135mm

Technician's scissors



6982  72/8.2/9.2/1.2'  80g

- Designed for stripping and cutting the cable and wire up to 2mm diameter.
- Serrated edges can prevent objects from slipping away.
- Impact grips designed to fit human body engineering for the comfort of holding
- The inner ring of grips are made of TPR soft material. Fingers won't hurt after a long time holding.
- With an adjustable joint screw.
- Length: 145mm

Technician's scissors



6983  72/4.3/5.3/1.1'  60g

- ABS grip
- Thickness 2.5mm
- Length: 145mm

Straight shears



5055P1	Cutting Length	<i>l</i>	
Part no.	mm	mm	g
5055P1	51	254-10"	480
5055P112	70	305-12"	650

Aviation tin snips



Straight Cut



Left Cut



Right Cut

698		<i>l</i>	Cutting Length	
Part no.	Direction	mm	mm	g
6981250	Straight cut	250	38	400
698L248	Left cut	248	35	400
698R248	Right cut	248	35	400

Offset snips



6985  48/24.0/25.0/1.97'  540g

- Material: CRM-63 steel blades
 - Hardness: 58-61 HRC
 - Blade: Black phosphate finish resists rust.
- Functions and features:
1. Special laborsaving design for easier cutting.
 2. Serrated edges allowing stable hold and preventing slipping when cutting.
 3. Center fastener for high tensile strength and longer life.
 4. Solid and comfortable handle with non-slip design.
 5. Hot drop forged blades: Alloy steel forged blades for greater strength and longer durability.

Scriber of wolfram steel









87901	<i>l</i>	
Part no.	mm	g
87901	145	20

- Include one tungsten lead and one carbon lead.

6pc 1/2"DR. Impact driver set









5064  20/19.0/20.0/0.62'  950g

	1pc	5/16" PH.2; PH.3 (36mmL)
	1pc	5/16" 9; 11 mm (36mmL)
	1pc	Impact driver (8174)
	1pc	1/2"DR.x5/16"

6pc 1/2"DR. Impact driver set











5064L  20/19.0/20.0/0.62'  950g

	1pc	5/16" PH.2; PH.3 (80mmL)
	1pc	5/16" 9; 11 mm (80mmL)
	1pc	Impact driver (8174)
	1pc	1/2"DR.x5/16"

17pc 1/2"DR. Impact driver set





5171  20/22.0/23.0/0.82'  1100g



	2pc	5/16" PH.2; PH.3 (36mmL)
	2pc	5/16" PZ.2; PZ.3 (36mmL)
	2pc	5/16" 9; 11 mm (36mmL)
	3pc	5/16" 6; 8; 10 mm (36mmL)
	5pc	5/16" T25; T30; T40; T45; T50 (35mmL)
	1pc	Impact driver (8174)
	1pc	5/16"Hex-3/8" Sq.
	1pc	1/2"DR.x5/16"

4pc Stud extractor set



5042  20/16.5/17.5/0.82'  825g



818 06...12	4pc	6; 8; 10; 12 mm
-------------	-----	-----------------

5042S  20/16.5/17.5/0.82'  825g

818 1.4...7.16	4pc	1/4"; 5/16"; 3/8"; 7/16"
----------------	-----	--------------------------

7pc Stud extractor set





5078  12/18.0/19.0/0.9'  1500g

818 05...14	7pc	5; 6; 7; 8; 10; 12; 14 mm
-------------	-----	---------------------------

Stud extractor



818			<i>l</i>		
Part no.	Drive	size	mm	g	pc/box
81805	3/8"	5	60	127	10
81806	1/2"	6	60	132	10
81807	1/2"	7	60	130	10
81808	1/2"	8	60	130	10
81810	1/2"	10	68	186	10
81812	1/2"	12	68	184	10
81814		14	68	253	10
8183.16	3/8"	3/16"	60	126	10
8181.4	1/2"	1/4"	60	126	10
8185.16	1/2"	5/16"	60	124	10
8183.8	1/2"	3/8"	68	176	10
8187.16	1/2"	7/16"	68	172	10
8181.2		1/2"	68	196	10

• For remove threaded, broken, rusted, stripped or smooth studs.

Stud extractor



818A  30/16.9/17.9/0.55'  560g

- Socket 1/2" DR. Stud Extractor.
- For remove threaded, stripped, rusted, broken and smooth studs.
- Stud range: 6 - 19mm (1/4" - 3/4")

Stud extractor



818B		<i>l</i>		
Part no.	DR.	mm	g	packing
818B01	3/8"	55	375	48/18.0/19.0/1.8'
818B02	1/2"	75	395	48/19.0/20.0/1.8'

- For removing threaded, broken, rusted, stripped or smooth studs.
- Stud Range: 6 - 12mm (1/4" - 1/2")

Nut buster



9U10A		size		
Part no.	Inch	Packing	g	
9U10A07	7	72/16.6/17.6/1.4'	230	
9U10A10	10	36/19.0/20.0/1'	525	
9U10A14	14	16/18.0/19.0/1.1'	1125	

- Polish finish

Quick-grip wrench



9U10B		size	
Part no.	mm	Jaw range	g
9U10B08	200-8"	8-19 (5/16"-3/4")	220
9U10B12	300-12"	14-32(9/16"-1-1/4")	590

- Chrome molybdenum steel
- Drop forged (CR-V) steel construction.
- Heat treated, sandblasted, and chrome plated.
- Fast ratcheting function removes or installs square or hex nuts and bolts, even stripped ones.

6pc 1/2"DR. Twist socket set



906U2 20/19.8/20.8/1.4' 990g

- Remove damaged bolts or rounded fasteners.

Contents:
5pc 1/2"DR. Twist socket (50mmL)
17; 19; 21; 23; 27 mm
1pc 12mm Straight rod

10pc 3/8"DR. Twist socket set



910U2 20/13.5/14.5/0.9' 675g

- Remove damaged bolts or rounded fasteners.

Contents:
9pc 3/8"DR. Twist socket
10; 11; 12; 13; 14; 15; 16(5/8"); 17; 19(3/4")
1pc 8mm Straight rod

12pc 3/8" & 1/2"DR. Twist socket set



912U3 20/15.5/16.5/0.9' 775g

- Remove damaged bolts or rounded fasteners.

Contents:
4pc 3/8"DR. Twist socket
8; 10; 12; 13 mm
6pc 1/2"DR. Twist socket
14; 15; 16; 17; 19; 21 mm
2pc Straight rod

T tap wrench (ratchet type)



881	Tap range	<i>l</i>	
Part no.	size	mm	g
8812090	1/8"-1/4" (3-6mm)	90	190
8812250	1/8"-1/4" (3-6mm)	250	280
8814110	1/4"-1/2" (6-12mm)	110	320
8814300	1/4"-1/2" (6-12mm)	300	460

Tap wrench



881A	Tap range	<i>l</i>	
Part no.	size	mm	g
881A06	1/4" (2-6mm)	175	100
881A10	3/8" (2-10mm)	225	220
881A13	1/2" (5-13mm)	275	330
881A19	3/4" (6-19mm)	380	600
881A25	1-1/8" (10-25mm)	480	1470
881A32	1-3/8" (14-32mm)	760	2450
881A38	1-5/8" (20-38mm)	1000	3800

Twist drill set



924U1 20/27.8/28.8/1.3' 1390g

- DIN 338 Typ N
- 130° pointed angle
- Titanium coated surface
- Right hand cutting
- Relieved cone has a ground point
- Cutting edge has thinning point
- High heat hardness constancy
- High performance steel

Contents:
25pc Twist drill
1.0; 1.5; 2.0; 2.5; 3.0; 3.5; 4.0; 4.5; 5.0;
5.5; 6.0; 6.5; 7.0; 7.5; 8.0; 8.5; 9.0; 9.5; 10.0;
10.5; 11.0; 11.5; 12.0; 12.5; 13.0 mm

10pc Combination extractor and drill set



910U1 48/16.0/17.0/2.2' 333g

- Contents five spiral extractors #1 through #5 and five mechanic's length hess drill, removes bolts and screws up to 5/8".
- Left hand extractors with right hand drills.

Contents:
5pc Hess drill size: 5/64"; 7/64"; 5/32"; 1/4"; 19/64"
5pc Screw extractor size: 5/64"; 7/64"; 5/32"; 1/4"; 19/64"

25pc Screw extractor / drill & guide set



925U1 20/11.6/12.6/1.2' 580g

- Fluted type extractors that provide a solid grip on broken studs and screws.
- These screw extractors do not expand the screw while turning and their special design ensures a positive grip when driven into the drilled out hole.
- Drill size is stamped on each extractor for ease of identification.
- Range: 3/16" to 9/16" (5 to 14mm)



5pc Straight flute screw extractor set



905U1 100/17.5/18.5/1' 175g

- Made of chrome molybdenum
- Heat treated
- Quick & easy way to remove broken screws, pipes, bolts & studs

Contents:
5pc Screw extractor
3/16" (M5) to 5/16" (M8)
5/16" (M8) to 3/8" (M10)
3/8" (M10) to 7/16" (M12)
7/16" (M12) to 9/16" (M14)
9/16" (M14) to 5/8" (M16)

5pc Screw extractor set



63005

100/15.3/16.3/1.6' 153g

9UXAM06	1pc	1/8" (M3) to 1/4" (M6)
9UXAM08	1pc	1/4" (M6) to 5/16" (M8)
9UXAM11	1pc	5/16" (M8) to 7/16" (M11)
9UXAM14	1pc	7/16" (M11) to 9/16" (M14)
9UXAM18	1pc	9/16" (M14) to 3/4" (M18)

5pc Screw extractor set



63005B

100/15.3/16.3/1.6' 153g

9UXBM06	1pc	1/8" (M3) to 1/4" (M6)
9UXBM08	1pc	1/4" (M6) to 5/16" (M8)
9UXBM11	1pc	5/16" (M8) to 7/16" (M11)
9UXBM14	1pc	7/16" (M11) to 9/16" (M14)
9UXBM18	1pc	9/16" (M14) to 3/4" (M18)

8pc Screw extractor set



63006

24/18.5/19.5/0.7' 830g

9UXAM06	1pc	1/8" (M3) to 1/4" (M6)
9UXAM08	1pc	1/4" (M6) to 5/16" (M8)
9UXAM11	1pc	5/16" (M8) to 7/16" (M11)
9UXAM14	1pc	7/16" (M11) to 9/16" (M14)
9UXAM18	1pc	9/16" (M14) to 3/4" (M18)
9UXAM25	1pc	3/4" (M18) to 1" (M25)
9UXAM28	1pc	1" (M25) to 1-3/8" (M35)
9UXAM32	1pc	1-3/8" (M35) to 2" (M50)

8pc Screw extractor set



63006B

24/18.5/19.5/0.7' 830g

9UXBM06	1pc	1/8" (M3) to 1/4" (M6)
9UXBM08	1pc	1/4" (M6) to 5/16" (M8)
9UXBM11	1pc	5/16" (M8) to 7/16" (M11)
9UXBM14	1pc	7/16" (M11) to 9/16" (M14)
9UXBM18	1pc	9/16" (M14) to 3/4" (M18)
9UXBM25	1pc	3/4" (M18) to 1" (M25)
9UXBM28	1pc	1" (M25) to 1-3/8" (M35)
9UXBM32	1pc	1-3/8" (M35) to 2" (M50)

Bolts & rounded fasteners extractor set



920U3

10/14.4/15.4/1.2' 1440g

- Remove damaged bolts, screws, nuts or round fasteners.

Contents:

- 1pc 3/8"DR. Quick-grip wrench 8-19mm (5/16"-3/4")
- 5pc Screw extractor (63005B)
 - 1/8" (M3) to 1/4" (M6);
 - 1/4" (M6) to 5/16" (M8);
 - 5/16" (M8) to 7/16" (M11);
 - 7/16" (M11) to 9/16" (M14);
 - 9/16" (M14) to 3/4" (M18)
- 10pc 3/8"DR. Twist socket
 - 8; 10; 11; 12; 13; 14; 15; 16; 17; 19 mm
- 1pc L type rod 6mm
- 1pc Adapter for 3/8" extension 3/8"(F)x3/8"(M)
- 1pc 3/8"DR. Extension 6"(150mm)
- 1pc 3/8"DR. Wobble extension 1.75"(44mm)

8pc Torx plus extractor set



908U2

20/10.0/11.0/0.6' 373g

- Special design of torx plus head, twist body with teeth and tap shape.
- High efficiency to remove damaged objects as below:
 - 1). Hex inside (no stripped)
 - 2). Stripped hex inside
 - 3). Round inside
 - 4). Stripped round inside
 - 5). Torx / torx plus / torx security inside
 - 6). Stripped torx / torx plus / torx security inside 7

Contents: (Application size)

- 8pc Torx plus extractor
 - 3mm (3.4~4.6mm), 4mm (4.3~5.9mm), 5mm (5.3~7.0mm),
 - 6mm (6.3~8.1mm), 7mm (7.4~9.2mm), 8mm (8.4~10.4mm),
 - 10mm (10.4~12.6mm), 12mm (12.4~14.0mm)

9pc Torx plus extractor set



909U1

50/10.0/11.0/0.75' 183g

- Special design of torx plus head, twist body with teeth and tap shape.
- High efficiency to remove damaged objects as below:
 - 1). Hex inside (no stripped)
 - 2). Stripped hex inside
 - 3). Round inside
 - 4). Stripped round inside
 - 5). Torx / torx plus / torx security inside
 - 6). Stripped torx / torx plus / torx security inside 7

Contents: (Application size)

- 8pc Torx plus extractor
 - T6 (1.5~2.7mm), T7 (1.7~2.9mm); T8 (2~3.4mm),
 - T9 (2.2~3.7mm), T10 (2.6~4.0mm), T15 (3.4~4.8mm),
 - T20 (3.6~5.0mm), T25 (4.2~5.8mm)
- 1pc Torx plus head

130pc Threaded coil-insert repair kit



9130U1

8/19.5/20.5/1.2' 2437g

Contents:

- 110pc Screw-coil, material: Stainless steel SUS304.
 - each 25pc M5-0.8*1.5D, M6-1.0*1.5D, M8-1.25*1.5D,
 - M10-1.5*1.5D,
 - 10pc M12-1.75*1.5D
- 5pc Tap, material: HSS.
 - M5-0.8, M6-1.0, M8-1.25, M10-1.5, M12-1.75
- 5pc Tang puncher, material: Carbon steel.
 - M5-0.8, M6-1.0, M8-1.25, M10-1.5, M12-1.75
- 5pc Drill, material: HSS.
 - 5.2mm, 6.3mm, 8.3mm, 10.4mm, 12.4mm.
- 5pc Main tool, material: Steel.
 - M5-0.8, M6-1.0, M8-1.25, M10-1.5, M12-1.75

Threaded coil-insert repair kit



929/924/912/910

Part no.	Size	pc	Packing	g
929U1	M5x0.8	29	30/8.2/9.2/1.7'	275
929U2	M6x1.0	29	30/9.2/10.2/1.7'	310
929U3	M8x1.25	29	30/11.6/12.6/1.7'	390
924U2	M10x1.0	24	30/13.8/14.8/1.7'	460
924U3	M10x1.25	24	30/13.8/14.8/1.7'	460
924U5	M10x1.5	24	30/13.8/14.8/1.7'	460
912U5	M12x1.25	12	30/16.5/17.5/1.7'	550
912U6	M12x1.5	12	30/16.5/17.5/1.7"	550
912U7	M12x1.75	12	30/16.5/17.5/1.7'	550
910U5	M14x1.25	10	30/18.6/19.6/1.7'	620
910U6	M14x1.5	10	30/18.6/19.6/1.7'	620

8pc Axle spindle rethreading set



67001

20/12.0/13.0/0.6' 600g

- This set is used to clean or repair axle threads on spindles.
- Use with 1-1/4" socket or wrench.

Contents:

- 8pc Axle spindle rethreading
 - M24x1.50, M24x2.00, M22x1.00, M22x1.50,
 - M20x1.50, M20x1.25, 3/4"x20UNEF, 13/16"x20UNEF



20pc Master spindle rethreading set



920U1

6/11.3/12.3/1.3' 1883g

- This 20pc set will repair or renew damaged threads on stub axles / spindles on most vehicles. Dies are made of high tempered steel for strength and durability. All dies have the same 1-1/4" (32mm) hex size. Stored in high impact blow mold case.

Contents:

- 7pc Imperial sizes:
 - 11/16"x24, 3/4"x16, 3/4"x20, 13/16"x20, 27/32"x20,
 - 7/8"x14, 1"x14
- 13pc Metric sizes:
 - 16x1.0, 16x1.5, 18x1.5, 19x1.5, 20x1.0, 20x1.25, 20x1.5,
 - 22x1.0, 22x1.5, 24x1.5, 24x2.0, 25x1.5, 27x2.0

15pc Metric rethreader set



915U1

10/6.2/7.2/0.57' 620g

- Seven metric rethreader dies, seven metric rethreader taps, one metric thread file.

Contents:

- 7pc Rethreader die sizes:
 - 6x1.00, 8x1.25, 10x1.25, 10x1.50, 12x1.25, 12x1.5, 12x1.75 mm
- 7pc Rethreader tap sizes:
 - 6x1.00, 8x1.25, 10x1.25, 10x1.50, 12x1.25, 12x1.5, 12x1.75mm
- 1pc Metric thread file



43pc UNF, UNC & Metric rethreader set



943U1  6/11.0/12.0/0.7'  1833g

Contents:

- 21pc Rethreader die sizes:
 - 1/4", 5/16", 3/8", 7/16", 1/2", 9/16", 5/8" UNC
 - 1/4", 5/16", 3/8", 7/16", 1/2", 9/16", 5/8" UNF
 - M6xP1.00, M8xP1.25, M10xP1.25, M10xP1.50, M12xP1.25, M12xP1.5, M12xP1.75 mm
- 19pc Rethreader tap sizes:
 - 1/4", 5/16", 3/8", 7/16", 1/2", 9/16" UNC
 - 1/4", 5/16", 3/8", 7/16", 1/2", 9/16" UNF
 - M6xP1.00, M8xP1.25, M10xP1.25, M10xP1.50, M12xP1.25, M12xP1.5, M12xP1.75 mm
- 2pc UNC and UNF thread file
 - Description pitch sizes:
 - SAE file: 11, 12, 13, 14, 16, 18, 20, 24
 - SAE file: 9, 10, 12, 16, 20, 27, 28, 32
- 1pc Metric thread file
 - Description pitch sizes:
 - 0.75, 1.00, 1.25, 1.75, 2.00, 2.50, 3.0 mm

External thread restorer files

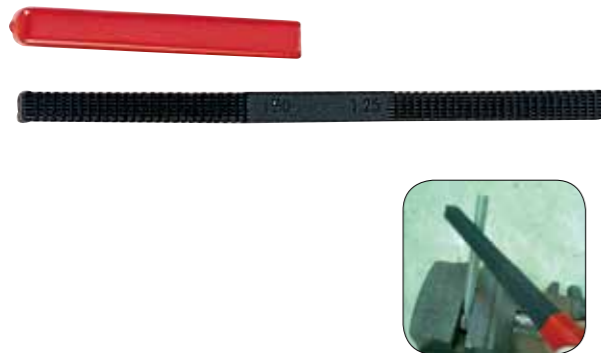

66901 / 66902 / 66903  72/15.0/16.0/1.2'  208g

- Rostore tool for renewing damaged thread on any diameter bolt, stud, axle of shaft file, both right and left threads.

66901
Description pitch sizes:
Metric file: 0.75, 1.00, 1.25, 1.50, 1.75, 2.00, 2.50, 3.00

66902
Description pitch sizes:
SAE file: 11, 12, 13, 14, 16, 18, 20, 24

66903
Description pitch sizes:
SAE file: 9, 10, 12, 16, 20, 27, 28, 32

External & internal restorer file



9U1101 / 9U1102  120/19.7/20.7/1.7'  164g

- Rostore tool for renewing damaged thread on bolt, stud, axle or shaft of any diameter. File both right and left hand threads.
- Designed for use in hidden & narrow area.

9U1101
Description pitch sizes:
Metric file: 0.80-1.00-1.25-1.50-1.75-2.00-2.50-3.00

9U1102
Description pitch sizes:
SAE file: 24-20-18-16-14-12-11-10

7pc Square thread tap set

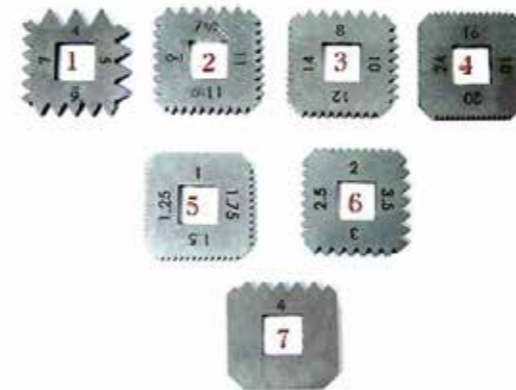

907U2  100/14.2/15.2/0.61'  142g

SAE:

- 1: 4N, 5N, 6N, 7N
- 2: 7-1/2N, 9N, 11N, 11-1/2N
- 3: 8N, 10N, 12N, 14N
- 4: 16N, 18N, 20N, 24N

Metric:

- 5: 1P, 1.25P, 1.5P, 1.75P
- 6: 2P, 2.5P, 3P, 3.5P
- 7: 4P

4pc Nut splitter set



672  12/18.5/19.5/0.87'  1540g

6720912	1pc	5/16" to 1/2" (9-12 mm)
6721216	1pc	1/2" to 5/8" (12-16 mm)
6721622	1pc	5/8" to 7/8" (16-22 mm)
6722227	1pc	7/8" to 1-1/8" (22-27 mm)

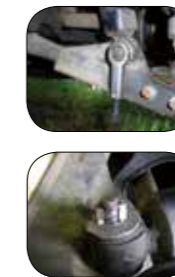

Universal nut cracker



9U1001  24/15.5/16.5/1'  645g

- Splits most stubborn nuts 7/16" (11mm) through 3/4" (19mm) across the flats.
- Works in channels not accessible by other tools.
- Parallel action of pusher cracks nuts without damaging bolt threads. Chisel rotates 360° to line up parallel to bolt. Simply tighten the screw until the nut splits.
- With a rugged drop-forged frame.
- Do not use on heat-treated nuts.
- Length: 6-3/4" serviceable product.

Grey cast iron bench vise (without base)



65401	Jaw	Throat	
Part no.	open	depth	packing
6540104	4"	2-5/8"	1/12.2/13.2/0.43'
6540105	5"	3-1/4"	1/13.7/14.7/0.6'
6540106	6"	3-3/4"	1/19.6/20.6/0.82'
6540108	8"	4"	1/26.8/27.8/0.97'

Drilling press vise



65404	Jaw	Throat	
Part no.	Open	Depth	Packing
6540403	2-3/4"	3/4"	2/3.2/4.2/0.16'
6540404	4"	1"	2/6.2/7.2/0.24'
6540405	5"	1"	2/11.0/12.0/0.3'
6540406	5-1/2"	1"	2/13.5/14.5/0.43'

Cross vise



65405	Jaw	
Part no.	Open	Packing
6540503	3"	1/6.2/7.2/0.31'
6540504	4"	1/10.0/11.0/0.44'
6540505	5"	1/13.5/14.5/0.5'
6540506	6"	1/16.5/17.5/0.65'

Forged steel bench vise



65406	Jaw	Throat	
Part no.	open	depth	packing
6540604	4"	8.4	1/8.4/9.4/0.3'
6540605	5"	12.5	1/11.5/12.5/0.63'
6540606	6"	20.5	1/19.5/20.5/1.02'

Heavy duty bench vise



65402...A			
Part no.	Size	kg	packing
6540204A	4"	7.7	1/7.3/8.3/0.36'
6540205A	5"	11.2	1/11/12/0.48'
6540206A	6"	14.5	1/14/15/0.57'
6540208A	8"	19.2	1/19.2/20.2/0.91'
6540210A	10"	25.6	1/27/29/1.4'

The nut and the base are one-piece forged, instead of being jointed together later by screws. The strengthened structure ensures the firm and steady joint between the base and the lead screw, and thus the jaws can provide you with powerful and sturdy grip to weighty pieces.



Heavy duty ductile octagonal supporting vise



65407			
Part no.	Size	kg	packing
6540706	6"	28	1/27/28/0.85'
6540708	8"	40.5	1/41/42/1.43'

The nut fits completely into the jaw. The nut which is not movable mates and works precisely with the lead screw.



Heavy duty ductile square supporting vise





65408			
Part no.	Size	kg	packing
6540804	4"	15	1/15/16/0.5'
6540805	5"	17	1/17/18/0.53'
6540806	6"	18.6	1/18.6/19.6/0.6'









The nut fits completely into the jaw. The nut which is not movable mates and works precisely with the lead screw.



9pc Measuring tools set



5096  6/10.0/11.0/0.9'  1666g

	1pc	5096P1	Steel vernier caliper
	1pc	5096P2	Auto center punch
	1pc	5096P3	Stainless steel straight ruler 30cm
	1pc	5096P4	Stainless steel protractor
	1pc	5096P5	Screw pitch gauges 0.25-6 (MM)
	1pc	5096P6	Screw pitch gauges 4-62 (SAE)
	1pc	5096P7	Steel scriber
	1pc	5096P8	5m measuring tape
	1pc	61802	Feeler gauges of 26 sizes (SAE & MM)

20pc Feeler gauge



618  100/10.4/11.4/1.1'  104g

- Length: 105mmL
- included 20 blades 0.05mm to 1.00mm

20pc Long feeler gauge 150mmL (rounded-rectangle-shaped)



618L  40/19.1/20.1/0.7'  185g

- Length: 150mmL
- Rounded-rectangle-shaped
- 20 blades - 0.05mm to 1.00mm

9pc Offset feeler gauge



61803  100/10.4/11.4/1.4'  104g

- Length: 100mmL
- Size: 0.009"-0.015"-0.016"-0.017"-0.018"
0.019"-0.020"-0.021"-0.026"
- Decimal sizes & metric equivalents on each blade
- Blades L xW: 4"x1/2" (100x13mm)

26pc Feeler gauge



61802  100/12/13/1.1'  120g

- Length: 95mmL
- included 26 blades
0.04mm(.0015");0.05mm(.002");0.06mm(.0025")
0.08mm(.003");0.10mm(.004");0.13mm(.005")
0.15mm(.006");0.18mm(.007");0.20mm(.008")
0.23mm(.009");0.25mm(.010");0.28mm(.011")
0.30mm(.012");0.33mm(.013");0.35mm(.014")
0.38mm(.015");0.40mm(.016");0.43mm(.017")
0.45mm(.018");0.48mm(.019");0.50mm(.020")
0.53mm(.021");0.55mm(.022");0.58mm(.023")
0.60mm(.024");0.63mm(.025")

Steel vernier caliper (A type)



5096P1A  48/12.0/13.0/1'  251g

- Length: 230mm

5096P1A30  20/13.6/14.6/0.9'  678g

- Length: 300mm

Measuring tape



5096P8			
Part no.	size	Packing	g
5096P803	3	100/20/21/2.6'	90
5096P8	5	100/20/21/2.6'	180
5096P808	8	60/21.6/22.6/2.2'	270
5096P810	10	60/27.5/28.5/2.2'	420

Auto-stop measuring tape

NEW



5096A8			
Part no.	size	Packing	g
5096A803	3	100/14/15/2.6'	140
5096A805	5	100/21.5/22.5/2.6'	215
5096A808	8	60/28.3/29.3/2.2'	472



Measuring tape

NEW



5096A8			
Part no.	size	Packing	g
5096A815	15	30/8/9/2.2'	256
5096A830	30	30/13/14/2.2'	433
5096A850	50	20/18/19/2.8'	900

Measuring tape 100M

NEW



5096P8100			
Part no.	size	Packing	g
5096P8100	100	10/15/17/2.6'	1306

Aluminum box level



891			
Part no.	Length	Packing	g
891300	12	60/13.0/14.0/1.2'	215
891400	16	48/13.0/14.0/1.3'	270
891600	24	36/14.0/15.0/1.4'	390

- 1.5mm thickness aluminum alloy body.
- Cylindrical vials
- Accuracy: 1mm/M

Micrometer



5096P9		
Part no.	Specification	Packing
5096P9025	0-25	50/15/16/0.6'
5096P9050	25-50	50/25/26/0.8'
5096P9075	50-75	30/24/25/1.2'
5096P9100	75-100	25/20/21/1'

5096P9050~5096P9100

Dial gauge



891A01

50/3.6/4.6/1.3' 71g

- Range: 0-8mm
- Reading: 0.01mm

Magnetic base



891B01

20/27.4/28.4/1.7' 1370g

- Holding power: 80kgw

Torque angle meter (clip)



9G1801 / 9G1801A 24/12.1/13.1/2.1' 500g

- **9G1801** is used with 1/2" DR.
- **9G1801A** is used with 3/4" DR.
- Commonly used for tightening head bolts and other bolts where a torque angle is required.

Torque angle meter (magnetic)



9G1802 / 9G1802A 24/11.3/12.3/2.1' 495g

- **9G1802** is used with 1/2"DR.
- **9G1802A** is used with 3/4"DR.
- Commonly used for tightening head bolts and other bolts where a torque angle is required.

Infrared thermometer



9U0401

20/3.5/4.5/2' 175g

- Laser indicator.
- Changeable between: °C and °F
- Temperature range: -20 to 500°C
- Operating temperature: 0 to 50°C
- Storage temperature: -20 to 50°C
- Precision: ±2.5% or 3°C
- Distance-to-Spot: 10:1
- Power supply: 9V battery

Hinged flexible inspection mirror



61703  36/11.0/12.0/2.3'  300g

- Mirror: 50x70mm
- Length: 510mm

Multi-function magnetic pick-up



617  100/8.9/9.9/1.1'  89g

- Magnetic pick-up tool in telescopic extended, maximum 63cm extension.
- Take off the cap of bottom, the needle point head can be used for marking when draw a line or clean the narrow slot and small hole.
- Attach a fully adjustable mirror for inspection.
- All-in-one handy tool with pocket clip.
- Length:235mm

3-in-1 Magnetic flexible pickup tool with light & mirror



617L  72/15.1/16.1/2'  210g

- Positive action turn on / off switch
- Magnetic pick-up 3.5lbs. (1.6kgw)
- Flexible shank of dia. 8.5mm and length 455mm(17-7/8")
- Oval glass mirror 25 x 50mm (1-1/8"x2")
- Replaceable bulb (2.2V, 0.25A)
- Inspection light is operated with 2pc AA batteries (not included)

Heavy-duty flexible magnet pick-up tool



61701  100/19/20/1.9'  190g

- Flexible shank diameter 8.5mm; 440mmL
- With plastic PVC grip
- Magnetic Capacity: 3.5Lbs(1.6Kgw)
- Overall length: 535mm(21")

Flexible magnet pick-up tool



61702  72/11/12/1.8'  150g

- Flexible shank diameter 5.0mm; 400mmL
- With plastic PP grip
- Magnetic Capacity: 1.5Lbs(0.7Kgw)
- Overall length: 510mm(20")

3-Claw pick-up tool



88901  150/15.1/16.1/1.2'  100g

- Length:560mmL

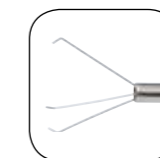

Telescopic magnetic pick-up tool



88902  200/12.0/13.0/1.2'  60g

- 7-section extension rod.
- Length: 135 mm - 65 mm.
- Magnetic capacity: 3.5LBS (1.6kg).
- With pocket clip.

EZ-release magnetic pick-up



88011  12/8.0/9.0/2.1'  660g

- 680mmL(26-3/4")
 - Capacity: 8 LBS (3.63 kg)
- Functions:**
- EZ- Release magnetic pick up tool has a magnetic device that is able to attract any metallic items or spare parts laying on the floor without having to go through the trouble and pick them up one by one.



Midi EZ-release magnetic Rectangular pick-up



88012 24/15.1/16.6/2.5' 630g

- 110x110x190mm
- Capacity: 10 LBS (4.54 kg)

Functions:

- Easy pick-up and release of metallic materials.
- Just squeeze the handle to quickly release material.

Power EZ-release magnetic pick-up



88013 20/12.8/13.8/2.9' 640g

- 400mmL(15-3/4")
- Capacity: 14 LBS (6.36 kg)

Functions:

- Quickly and safely clean up iron, steel chips and waste. Used for safe handling of sharp off cuts, separating small parts and steel scrap for nonferrous surfaces

Round magnetic tray



88001 30/12.0/13.0/1.5' 400g

- Ø150mmL
- Functions:
 1. One heavy duty 1000 ~ 1200 gauss permanent magnets.
 2. Vulcanized rubber coating prevent scuffing and scratching to valuable surface.
 3. Stainless steel tray resists corrosion.
 4. Can be used horizontally, vertically, and upside down.
 5. Convenient for collecting small parts and tools.

Rectangular magnetic tray(2 magnets)



88002 20/14.7/15.7/2.28' 735g

- L242mm x W132mm
- Functions:
 1. 5-1/2" x 9-1/2" x 1-1/2" rectangle Stainless steel tray.
 2. Two Heavy Duty magnets with durable rubber coating to help prevent scuffing and scratching.
 3. Great for small parts, fasteners and tools.
 4. Can be used horizontally, vertically or upside down.

Rectangular magnetic tray(3 magnets)



88003 12/15.0/16.0/1.4' 1250g

- L360mm x W160mm
- Functions:
 1. 14-1/8" x 6-1/4" x 1-1/2" rectangle Stainless steel tray.
 2. Three Heavy Duty magnets with durable rubber coating to help prevent scuffing and scratching.
 3. Great for small parts, fasteners and tools.
 4. Can be used horizontally, vertically or upside down.

Square magnetic tray



88004 6/8.5/9.5/1.42' 1420g

- L293mm x W270mm
- Functions:
 1. Square Stainless steel tray.
 2. Heavy Duty magnets with durable rubber coating to help prevent scuffing and scratching
 3. Great for small parts, fasteners and tools
 4. Can be used horizontally, vertically or upside down

LED white light, clip-type (360° rotation)



68601 240/14.7/15.7/4' 61g

- 3 LEDS.

Limber magnetic LED light



68602 120/10.2/11.7/3.5' 85g

- 3 LEDS.

Magnetic LED head light



68603

100/12.7/13.7/3.55' 127g

- 11 LEDS.



Flash Light



68607

30/6.6/7.6/0.4' 220g

- 6 LEDS
- Battery: AAA x 3pc
- Size: 36x28x95 mm

10W LED working light



68608

20/12.0/13.0/1.6' 490g

- Size: 330 x 95 x 100 mm
- Charging time: 3.5~4 hours
- Input power: AC 100~240V, DC 12V~24V
- Battery: 3.6V 2250mAh NI-MH
- Working time: 4 hours when fully charged
- Activetime: 2.5 hours



Ultra COB LED slim light (lumen-adjustable switch)



68611

20/6.5/7.5/1.2' 325g

- Specifications:
 - A. LED Max power: 15W LED COB light
 - B. Li-ion Rechargeable battery: 3.7V 2200mAh
 - C. Charger input: AC100~240V 50/60Hz
 - D. Power output: 5.0V 1000mAh
 - E. Charger time: 3.5~4.0 hours
 - F. Avtive time: 2.5 hours
 - G. Storage temperature: -20°C to 70°C
 - H. Operation temperature: -5°C to 50°C
 - I. Product size: 375(L)x40(W)x30(H) mm
- Features:
 1. Micro adjustment lumen switch
 2. Foldable base with powerful magnet
 3. Swivel hanging hook
 4. Built-in 2200 mAh LI-ion battery
 5. For full light-approx 2.5 hours working hours, for semi light-approx 10 working hours
 6. 4 hours charging time:
 - in charging -red indicator flash, charged completed-blue indicator light on, low battery -yellow indicator flash
 7. Comes with 5V 1A USB charger & USB cable



5W COB LED pen light



68612

100/8/9/1.4' 82g

- Size: 165x25x30 mm
- 5W LED COB light
- 360 degree of rotation
- Clip with magnet

14 LED Work light with magnifying head



68610



20/18.5/20.0/2.7' 925g



- LED white light bulb.
- 3x magnifying glass.
- Magnifying glass's diameter is 4".
- Could be supplied power by the two kinds of options which are the 2 pcs of AAA battery or AC transformer
- Magnetic base attaches firmly to any metal surface.
- Power:AAA battery x 2 (1.5V/pc).
- Transformer (Input : AC100V / AC240V ; Output : DC4.5V).



17pc 3/8"DR. Insulated socket set















3173N  10/21.0/22.0/1.8'  2100g

	14pc	6; 7; 8; 9; 10; 11; 12; 13; 14; 15; 16; 17; 18; 19 mm
	1pc	Insulated ratchet handle 45teeth (802320N)
	2pc	6"(150mm); 10"(250mm)

31pc 3/8"DR. Insulated combination set











3313N  3/11.9/12.9/1.5'  4000g

	14pc	6; 7; 8; 9; 10; 11; 12; 13; 14; 15; 16; 17; 18; 19 mm
	1pc	Insulated ratchet handle 45teeth (802320N)
	2pc	6"(150mm); 10"(250mm)
	1pc	7"(175mm)
	1pc	6.3"(160mm)
	1pc	6.3"(160mm)
	2pc	PH.1 (80mmL); PH.2 (100mmL)
	3pc	2.5mm (75mmL); 4mm (100mmL); 5.5mm (125mmL)
	5pc	7; 8; 10; 12; 14 mm
	1pc	Screwdriver probe voltage tester 110-250V AC (88401)

10pc Insulated pliers and screwdriver set





51016N  3/9.1/10.1/1.5'  3030g









	1pc	Multi-functional stripper pliers (6805A)
	1pc	8"(200mm)
	1pc	8"(200mm)
	1pc	8"(200mm)
	2pc	PH.1 (80mmL); PH.2 (100mmL)
	3pc	2.5mm (75mmL); 4mm (100mmL); 5.5mm (125mmL)
	1pc	Adjustable non-contact wire tracer (88407)

15pc Insulated combination set

NEW



5157N  3/11.3/12.3/1.5'  3758g

	1pc	10"(250mm)
	1pc	Multi-functional stripper pliers (6805A)
	1pc	8"(200mm)
	1pc	8"(200mm)
	1pc	6.3"(160mm)
	2pc	PH.1 (80mmL); PH.2 (100mmL)
	6pc	2.5mm (75mmL); 3mm (100mmL); 3.5mm (100mmL); 4mm (100mmL); 5.5mm (125mmL); 6.5mm (150mmL)
	1pc	Curved 6"(150mm)
	1pc	Screwdriver probe voltage tester 110-250V AC (88401)

3/8"DR. 12pt. Flank insulated socket



539N	Size	<i>l</i>	
Part no.	mm	mm	g
53906N	6	43	28
53907N	7	43	30
53908N	8	43	30
53909N	9	43	30
53910N	10	43	30
53911N	11	43	30
53912N	12	44	30
53913N	13	44	31
53914N	14	44	38
53915N	15	44	47
53916N	16	46	47
53917N	17	46	54
53918N	18	46	58
53919N	19	46	61

3/8" DR. Insulated extension



8043N	<i>l</i>	
Part no.	mm-inch	g
8043150N	150-6"	160
8043250N	250-10"	260

3/8" DR. Insulated torque wrench



6473268N  12/20.4/21.2/1.12'  1700g

- 3/8"DR. 5-25Nm

3/8"DR. Insulated ratchet handle (45teeth)



802320N  20/7.86/8.86/0.71'  354g

- Length:200mm

3/8"DR. Insulated extension T handle





7743200N  50/21.78/22.78/1.7'  400g

- Drive:3/8"
- Length:207mm
- Weight:400g



Insulated combination pliers



6901225		<i>l</i>	
Part no.	packing	mm	g
6901225	30/15.8/16.8/1'	225-9"	528



Insulated bent nose pliers



6902		<i>l</i>	
Part no.	packing	mm	g
6902160	60/11.1/12.1/0.64'	160-6"	185
6902200	60/17.4/18.4/0.93'	200-8"	290



Insulated combination pliers



6903		<i>l</i>	
Part no.	packing	mm	g
6903160	60/15.0/16.0/0.93'	160-6"	250
6903180	60/18.0/19.0/0.93'	180-7"	300
6903200	60/22.5/23.5/1.3'	200-8"	375



Insulated long nose pliers



6904		<i>l</i>	
Part no.	packing	mm	g
6904160	60/11.1/12.1/0.64'	160-6"	185
6904200	60/17.4/18.4/0.9'	200-8"	290



Insulated diagonal cutting pliers



6905		<i>l</i>	
Part no.	packing	mm	g
6905160	60/14.4/15.4/0.9'	160-6"	240
6905180 NEW	60/20/21/2.1'	180-7"	284

Insulated cable cutter



6909250		<i>l</i>	
Part no.	packing	mm	g
6909250	30/15.9/16.9/1'	250-10"	530



Insulated waterpump pliers (Curved jaw)



6907250		<i>l</i>	
Part no.	packing	mm	g
6907250	30/16.8/17.8/1.5'	250-10"	280

Insulated diagonal pliers



6911		<i>l</i>	
Part no.	packing	mm	g
6911180	60/15.3/16.3/0.93'	180-7"	255
6911200	60/17.4/18.4/0.93'	200-8"	290

Insulated long round nose pliers



6908160		<i>l</i>	
Part no.	packing	mm	g
6908160	60/10.2/11.2/0.64"	160-6"	170

Insulated wire stripper pliers



6912160		<i>l</i>	
Part no.	packing	mm	g
6912160	60/11.4/12.4/1.6'	160-6"	190

Insulated flat nose pliers



6913160		<i>l</i>	
Part no.	packing	mm	g
6913160	60/12.0/13.0/0.64'	160-6"	200

Insulated cable cutter



6914		<i>l</i>	
Part no.	packing	mm	g
6914160	60/10.8/11.8/1.3'	160-6"	180
6914200	60/18.0/19.0/1.5'	200-8"	300

Insulated screwdriver



711N

• Please refer to P4-65

712N

• Please refer to P4-65

713N

• Please refer to P4-65

Insulated hex nut driver



744N

• Please refer to P4-65

Fully insulated adjustable wrench



649M		<i>l</i>	
Part no.	packing	mm	g
649M200	40/13.6/16.5/1.2'	200	320
649M250	24/15.4/16.9/1.1'	250	640
649M300	16/16/17.5/1.05'	300	980

Insulated adjustable wrench



649N		<i>l</i>	
Part no.	packing	mm	g
649N200	64/18.2/19.2/0.81'	200	285
649N250	32/16.6/17.6/0.7'	250	520
649N300	16/15.4/16.9/1.1'	300	920

Insulated open end wrench



829	Size	<i>l</i>	
Part no.	mm	mm	g
82907	7	89	20
82908	8	99	26
82910	10	114	40
82912	12	134	61
82914	14	155	96
82917	17	190	147

Insulated 75° offset ring wrench



829A	Size	<i>l</i>	
Part no.	mm	mm	g
829A07	7	147	52
829A08	8	156	62
829A10	10	167	73
829A12	12	188	90
829A14	14	199	135

Insulated knife



83001



83002

830		<i>l</i>	
Part no.	Shape	mm	g
83001	Straight	150	145
83002	Curved	150	148

Screwdriver probe voltage tester

88401  200/6.5/7.5/4.6'  33g



- Testing range: 110~250V AC.
- Length: 140mm



Screwdriver probe voltage tester

88402  200/9.6/10.6/4.6'  48g



- Testing range: 110~250V AC.
- Length: 190mm

Screwdriver probe voltage tester

88403  200/10.0/11.0/4.6'  50g



- Testing range: 110~250V AC.
- Length: 155mm



Screwdriver probe voltage tester

88404  100/6.8/7.8/4.6'  68g



- Testing range: 110~250V AC.
- Length: 190mm



Adjustable non-contact wire tracer

88407  100/5.4/6.4/1.3'  54g



- Testing range: 12~600V AC 50~60HZ.
- Locates breaks along live, insulated wires and power cords.
- Adjustable sensitivity allows tracing of wires behind walls, around switches or receptacle.
- Easy to recognize by audio signal and LED indicator.
- Operates by two LR44, 1.5V batteries included.

Universal voltage tester

88408  60/8.5/9.5/2.7'  142g



- Testing range: 6~400V AC / DC.
- This voltage tester is designed for industrial purposes and hobbyists and is suitable for domestic voltage and heavy current circuits.
- Display: $\pm 6, 12, 24, 50, 120, 220$
400V AC / DC=LED
(ED): 30sec
I max: 30mA

Ratchet terminal tool kit



68013  10/10.6/11.6/1'  1060g

- Crimps insulation, non-insulation & open barrel terminals.
- Built-in ratchet with safety release assures uniform crimp every time.
- It releases and opens automatically when crimping is done.
- Applicable:
 - Insulated terminal
AWG 0.5-1.0 / 1.5-2.5 / 4.0-6.0 mm² (68013-H1)
 - Cord-end insulated terminal
AWG 0.5 / 0.75 / 1.0 / 1.5 / 2.5 / 4.0 mm² (68013-H2)
 - Open barrel non-insulated terminal
AWG 0.5-1.0 / 1.1-2.5 / 4.0-6.0 mm² (68013-H3)
 - Non-insulated terminal
AWG 1.0 / 2.0 / 4.0 / 6.0-10 mm² (68013-H15)

Contents:

- 1pc Terminal pliers (6803)
(include 1pc 68013-H3)
- 3pc Die nests (68013-H1, 68013-H2, 68013-H15)
- 1pc Wire stripper
- 1pc Hex key wrench

Terminal pliers red, blue, yellow



6801  30/16.2/17.2/1.5'  540g

- For terminal: 

(The terminals are not included.)

Terminal pliers 0.5; 0.75; 1.0; 1.5; 2.5; 4



6802  30/16.7/17.7/1.5'  557g

- For terminal: 

(The terminals are not included.)

Terminal pliers 0.5-1; 1.1-2.5; 4-6



6803  30/16.1/17.1/1.5'  535g

- For terminal: 

(The terminals are not included.)

Crimp lever pliers



6807  30/16.5/17.5/1.5'  550g

- Suitable for RG58, RG59/62, BNC/TNC coaxial connectors
- Size: 0.256(6.48mm), 0.319(8.13mm), 0.068(1.73mm), 0.213(5.41mm)

Terminal pliers 1; 2; 4; 6-10



68015  30/17.14/18.1/1.5'  570g

- For terminal: 

(The terminals are not included.)

Stripper pliers



6804  60/14.3/15.5/1.7'  220g

- Two functions:
A cutter & a stripper for electrical cables of 0.2mm² to 3.5mm² in diameter.

Wire stripper pliers



6804B160  60/9.6/10.6/1.3'  160g

- Length: 160mm-6.3"

Multi-function stripper pliers



6805A  60/20.1/21.1/2.5'  335g

- Remove the layer and cut off the wire of AWG 10~AWG 24 (02 ~ 6.0 mm²), the tool will not hurt the internal lines and keep the terminal steady.
- Crimp 10-22 AWG (0.5 ~ 6.0 mm²) insulated terminals.
- Crimp 10-22 AWG (05 ~ 6.0 mm²) non-insulated terminals.
- Crimp 7-8 mm ignition terminals.

Multi-purpose crimping tool



6806  40/11.7/12.7/1'  293g

- Function:**
- Wire cutter
 - Crimps insulated terminals
 - Bolt cutter
 - Crimps non-insulated terminals (open barrel)
 - Wire stripper

Cable, wire stripper



68011  200/25.5/26.5/3.1'  125g

- Remove the layer and cut off the electrical cable
- For wire 0.8~2.6 mm
- Cable stripper for the wire under 9.5mm



Cable Stripper



6808  100/10.0/11.0/1.8'  100g

- Able to strip cable up to 4mm - 28mm(dia.).

Cable Stripper



6809  100/11.0/12.0/2.1'  100g

- Able to strip cable up to 8mm - 28mm(dia.).

Cable Stripper



68010  100/12.5/13.5/2'  220g

- Able to strip cable up to 4.5mm - 25mm(dia.).

Telecrimper



68012  48/19.0/20.0/1.5'  400g

- Cuts, strips & crimps integral in one tool.
- With built-in length stop for precisely length stripping.
- 2 crimp functions with a single tool without changing dies.
- Advanced ratchet system.
- Precision CNC grounded crimping teeth.
- Crimp RJ45 & RJ11 Modular plugs.



Magnetic fender cover with 4 pockets



88801

17/16.7/17.7/4' 980g

- Size:110cmx56cm
- Front cover made with PVC Sponge leather, backing is TR/BRUSH which does not damage or scratch any surface.
- Top row includes STRONG magnets, which attract and stay on any metal surface easily.
- Easy to open and fold into compact size.
- The magnets are removable and replaceable before and after washing the fender cover.

Magnetic fender cover w/o pockets



88802

18/13.2/14.2/4' 734g

- Size:110cmx56cm
- Front cover made with PVC Sponge leather, backing is TR/BRUSH which does not damage or scratch any surface.
- Top row includes STRONG magnets, which attract and stay on any metal surface easily.
- Easy to open and fold into compact size.
- The magnets are removable and replaceable before and after washing the fender cover.

Magnetic fender cover w/o pockets

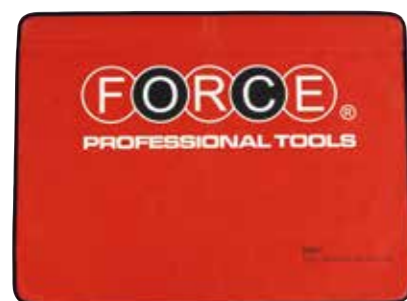

88803

18/10.2/11.2/4' 566g

- Size:80cmx60cm
- Front cover made with PVC Sponge leather, backing is TR/BRUSH which does not damage or scratch any surface.
- Top row includes STRONG magnets, which attract and stay on any metal surface easily.
- Easy to open and fold into compact size.
- The magnets are removable and replaceable before and after washing the fender cover.

Magnetic fender cover w/o pockets



88804

18/11.9/12.9/4' 660g

- Size:108cmx39cm
- Front cover made with PVC Sponge leather, backing is TR/BRUSH which does not damage or scratch any surface.
- Top row includes STRONG magnets, which attract and stay on any metal surface easily.
- Easy to open and fold into compact size.
- The magnets are removable and replaceable before and after washing the fender cover.

Seat cover



G81

50/17.3/18.3/1.5' 350g

- Size:140cmx70cm

Steel creeper



9U0311

1/8.0/9.0/1.8' 8kg

- Six wheels make the movements easily.
- The pillow is removable and replaceable.
- Size: 93×50×12 cm

Steel car seat



9U0312  1/7.5/8.5/1.4'  7.5kg

- Size: 40 × 30 × 30 cm
- Tools not included.

Steel car seat



9U0313  1/6/6.7/1.08'  6kg

- Strong and stable frames.
- Plastic corner for protection

Auto-rewinder air hose reel



9U0201  3/20/21/3'  6500g

- Size: 330 x 150 x 410 mm
- Inlet / Outlet: 1/4"
- Maximum Pressure: 300 PSI
- Hose Length: 15m
- Hose I.D.: 5/16"

Auto-rewinder air hose reel



9U0201A  20/19/20/3'  6335g

- Size: 330 x 150 x 410 mm
- Inlet / outlet: 1/4"
- Maximum pressure: 300 PSI
- Hose length: 12M
- Hose I.D.: 3/8"

High-volume air nozzle (slide type)



9U0221  1/7.5/8.5/1.4'  18g

- Equip the nozzle on pipes, in spiral direction, and tighten the bolt and the nozzle onto pipes.
- High-volume air nozzle produces triple the air volume that triples that of a regular blow gun.
- Inner O-ring attachment design, protect pipes of air blow gun.
- Applicable for any air blow guns with Ø6mm or Ø8mm pipes.



Air blow gun



9U0202



9U0203

9U0202  60/10/11/1.6'  167g
9U0203  50/12/13.5/2.9'  240g

It is suitable for removing and cleaning any kinds of chip.

Specification:

- Length: 4" (9U0202) / 13" (9U0203)
- Working pressure: 78~120 PSI / 5~8 KGS
- Thread type: 1/4"

Extendable air blow gun



9U0204

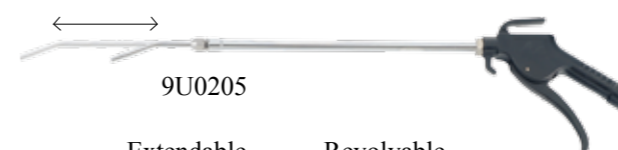

9U0205

Extendable Revolvable



9U0204  60/17/18/2.5'  283g
9U0205  50/13/14/2.9'  260g

- Special extendable tube and swivel angle can work in any kinds of area.
- Specification:**
- Length: 7~12" (9U0204) / 13"~24" (9U0205)
- Working pressure: 78~120 PSI / 5~8 KGS
- Thread type: 1/4"

Multi-functional air blow gun



9U0206

- The air nozzle is slidable.
- Air volume regulator : Regulator fixed amount of air volume output.
- Suitable for any industries, such as factories, machine tools, vehicles etc.

Air/Hydraulic pump 1600 c.c.



9U4501

2/15.1/16.1/0.8' 1890g

- Usable oil capacity: 1600 cc
- Rated pressure: 10000 psi

Performance chart											
Pressure (psi)	0	1000	2000	3000	4000	5000	6000	7000	8000	9000	10000
Oil flow (c.c./min)	1250	913	718	598	513	475	393	315	257	233	193

Service jack 3 Ton



9U3921

1/67.0/71.0/4.6' 67000g

- Ideally suited for all automotive, agriculture and light truck repair facilities.
- Pump is operated by both activating foot pedal to provide speed to contact the load, and activating " T " handle to lift it.
- Hydraulic power unit with dust seals to prevent oil contamination.
- Large heavy duty rear swivel caster wheels provide easy maneuvering and positioning of jack.

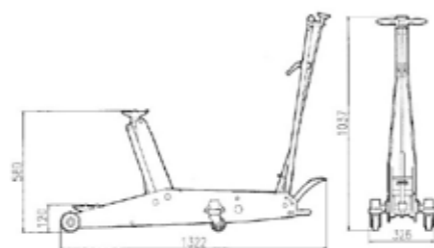

Jack stands



9U39

- These models incorporate a lever and ratchet assembly for adjusting the height.
- Same as Model 9U3902 but these models are newly designed with rubber pads which can prevent the auto body from damage.

Part No.	Capacity	Height range (ton)	Base Size (mm)	Packing (mm)	g
9U3901(one pair)	3 ton	270-420	177 x 194	1/6.0/6.6/0.66'	6000
9U3902(one pair)	3 ton	290-440	177 x 194	1/6.6/7.2/0.66'	6600

Jack stands



9U39

- These models are designed for use with trucks, height adjustment is made using the knurled nut and threaded stud.

Part No.	Capacity	Height range (ton)	Base Size (mm)	Packing (mm)	g
9U3903	12 ton	456-710	ψ467	1/18.5/19.5/0.7'	18500
9U3904	12 ton	614-868	ψ590	1/21.0/22.0/1.0	21000
9U3905	12 ton	710-1065	ψ670	1/25.0/26.0/1.0	25000

Truck jack stands



9U39

- The jack stands are of heavy-duty design and high strength legs for truck & bus support.
- 9U3911 & 9U3912 are designed with rubber pad which can prevent the truck & bus body from damage.

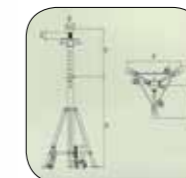

Item No.	Capacity (ton)	A (mm)	B (mm)	C (mm)	D (mm)	E (mm)	F (mm)	G (mm)	W (kgw)	Packing	g
9U3911	6.8	803	235.5	445	127	0	540	870	47	1/43.5/46.0/3.27	43500
9U3912	6.8	803	235.5	445	127	70	670	1426.5	59	1/56.0/59.0/4.67	56000
9U3913	15	948.5	308.5	513	127	70	700	1389	98	2/196.0/211.0/58.3	98000

Lever type grease gun

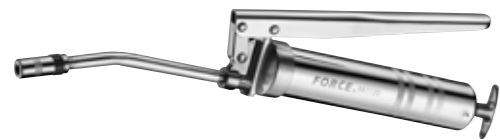

887120  40/24.2/25.9/1.6'  605g

- Electroplated finish for long service life
- Short-stroke "lever action" for easy use
- Uses 120 c.c. bulk grease.

Lever type grease gun



88704 w/Metallic bant spout



88704H9 w/Flexible hose 9"

88704 / 88704H9  20/23.0/26.9/2.3'  1.3kg

- Electroplated finish for long service life
- Short-stroke "lever action" for easy use
- Vented head cap for easy filling
- Use standard 14 oz. grease cartridge
- 3-ways loading: Standard 14 oz. cartridge, pressure filler and bulk 400 c.c.

Hand grease gun (400c.c.)





887400P  12/16/17/1.6'  1330g

- Chrome-plated finish for long service life.
- Pistol grip "lever action" for easy use.
- Vented head cap & positive lock for easy filling.
- Knurled thick wall barrel for secure grip.
- Uses standard 14oz. grease cartridge.
- Working Pressure: 4300 P.S.I.
- 100mm straight pipe with standard coupler.
- Pistol type with 4-1/2" metal spout.

Air grease gun combination kit



887				
Part no.	Size	mm	g	Packing
88701	14 o.z./400 c.c.	380	2600	8/18.2/21.1/2'
88701L	16 o.z./500 c.c.	380	2775	8/19.6/22.7/2'

- 1pc Air grease gun
- 1pc 1/4" Quick release coupler
- 1pc 1/4" Hose fitting
- 1pc Metallic bend spout
- 1pc 9" High pressure nylon hose
- 1pc Manual operated gun head

Features:

- 360°angle-free rotating & continuous flow.
- Where there is no air source or air hose can't reach, you can change the air gun head to the hand-operated gun head to proceed lubrication by manual operation.

Oil suction gun (500 c.c.)



887A500  20/17.0/18.0/1.4'  850g

- Perfect for removing or replacing oil in engine/ transmissions/ differentials gearbox sumps/ crankcases, enables easy access to awkward locations.
- Ideal for vehicle & machinery use
- Knurled thick wall barrel for secure grip
- 10" Flexible hose
- Capacity Bulk:20 oz / 550 cc

Metal oil can (350ml)



887C01  48/15.4/16.4/4.4'  316g

- Angled spout enables lubricating in difficult-to-access locations.
- Robust pump provides trickle feed supply.
- Material of container:steel
- Material of pump:copper
- Volume of container:350 ml

Metal oil can with flexible spout (350ml)



887C02

48/16.2/17.2/4.4' 316g

- Flexible spout enables lubricating in difficult-to-access locations.
- Robust pump provides trickle feed supply.
- Material of container: steel
- Material of pump: copper
- Material of flex spout: PVC
- Volume of container: 350 ml

Plastic oil can with flexible spout (500ml)



887C03

40/9.9/10.9/4.4' 220g

- Flexible spout enables lubricating in difficult-to-access locations.
- Robust pump provides trickle feed supply.
- Material of container: HDPE
- Material of pump: copper
- Material of flex spout: PVC
- Volume of container: 500 ml

Flexible metal funnel



887D01

10/3.4/4.4/2.6' 340g

- Galvanized steel funnel with metallic flexible spout with mesh filter.
- For filling oil easily at inaccessible area.
- Tube length : 370 mm

Oil barrel pump



887P01

10/22.3/23.3/1.9' 2230g

- Two-piece telescopic suction tube fits 15 to 55 gallon drums.
- Tube adjusts from 19-9/32" to 35" (490mm to 890mm)
- Dispenses approximately 350 c.c. per stroke.
- 2" and 1-1/2" NPT bung nuts are equipped.

Oil bucket pump



887P02

4/13/14/4' 3250g

- For transferring of transmission, differential and heavier oils.
- Fits 25-50 lb (5-gallon pail) original refinery and 12" I.D. (300mm) clamp-on-carry bucket.
- Dispenses approximately 2 oz.(59 c.c.) per stroke.
- 5 ft. Oil-resistant hose.

Aluminum rotary pump

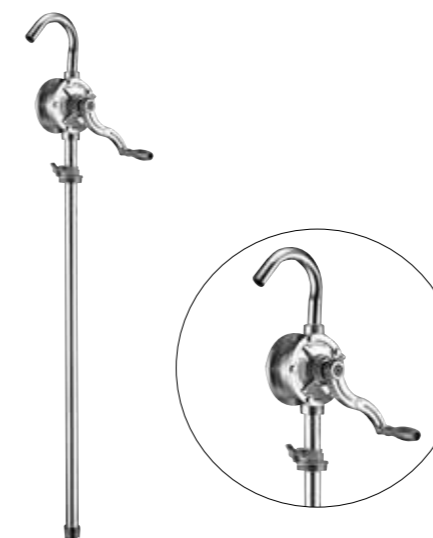



887P03





6/17.5/18.5/1.4' 2915g

- 887P03 with aluminum alloy body, PPS rotor, PPS vane, FKM seal, spout and suction tube is plate.
- Application: gasoline, diesel fuel, kerosene, lubricant, ethyl alcohol.
- Capacity: 280 CC /rotation.

4pc Jumbo heavy duty pry bar set









904U2  2/17.5/18.5/1.4'  8730g

	1pc	904U2-2470	24"x70°
	1pc	904U2-2490	24"x90°
	1pc	904U2-3600	36" straight
	1pc	904U2-3635	36"x35°

4pc Pry bar set









904U5  12/17.0/18.0/1.5'  1420g

	1pc	904U508	8"(200mm)
	1pc	904U512	12"(300mm)
	1pc	904U518	18"(450mm)
	1pc	904U524	24"(600mm)

4pc Pry bar set





904U6  10/17.0/18.0/1.1'  1700g

	1pc	904U606	6"(150mm)
	1pc	904U612	12"(300mm)
	1pc	904U616	16"(400mm)
	1pc	904U620	20"(500mm)

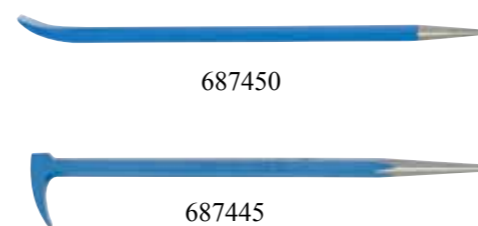
Pry bar



687  

Part no.	Length	g	Packing
687450	450mm (17.72")	923	40/26.5/27.5/0.7'
687445	445mm (17-1/2")	846	20/17.6/18.6/0.7'

• Material: S45C

Crowbar with crook beak





687400H  40/18.6/19.6/0.47'  465g

- Bending tool
- Length : 400mm (16")
- Bended head, hexagonal shank

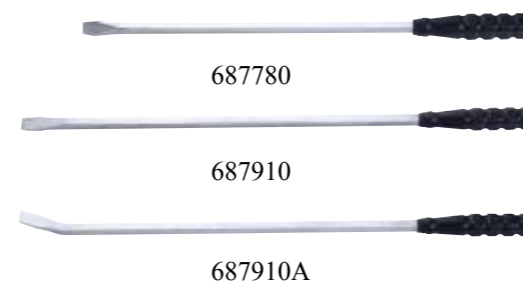
Jumbo pry bar



687  

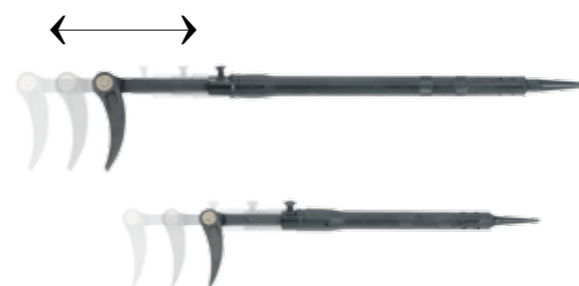

Part no.	Length	g	packing
687780	780mm-30.7"	1085	20/20/21/0.8'
687910	910mm-36"	1830	12/22.0/23.0/0.5'
687910A	910mm-36"	1830	12/22.0/23.0/0.59'

Free long pry bar.





- 68790 / 68755**
- Auto repair tool.
 - Machine repair tool.
 - Space saving.
 - Easy to carry and store.
 - Any end part can be made available at your request.



Item no.	Slide Shank	Min. Length	Max. Length	 (kg)	Moment (kgf.m)	 Packing
68790	16 mm Hex	65.5 cm 25.8"	90.5 cm 35.6"	2.0	50	8/16.0/16.8/1.6'
68755	13 mm Hex	42.0 cm 16.5"	55.5 cm 21.8"	0.9	35	20/18.0/19.0/0.94'

Fixed type adjustable hook wrench





823	size		
Part no.	mm	Packing	g
823035	15-35	60/6.6/7.6/1'	110
823050	35-50	60/12.6/13.6/1'	210
823080	50-80	40/17.0/18.0/0.9'	425
823120	80-120	20/15/16/0.92'	750
823180	120-180	12/17/18/1'	1400

• For use on slotted retaining rings.

Pin type adjustable hook wrench



823A	size		
Part no.	mm	Packing	g
823A035	15-35	60/6.6/7.6/1'	110
823A050	35-50	60/12.6/13.6/1'	210
823A080	50-80	40/17.0/18.0/0.9'	425
823A120	80-120	20/15/16/0.92'	750
823A180	120-180	12/17/18/1'	1400

• For use on slotted retaining rings.

Gear puller - 2 Jaw



65901	size	Capacity	Spread(mm)
6590103	3"	2 tons	40/75
6590104	4"	4 tons	50/100
6590106	6"	6 tons	70/150
6590108	8"	10 tons	95/200
6590112	12"	15 tons	140/300



Gear puller - 3 Jaw



65902

Part no.	size	Capacity	Spread(mm)
6590203	3"	3 tons	40/75
6590204	4"	6 tons	50/100
6590206	6"	9 tons	70/150
6590208	8"	15 tons	95/200
6590212	12"	22 tons	140/300



Gear puller - 2 Arm



65903

Part no.	Jaw open	Capacity	
	mm	ton	kg
65903065	25-65	1.5	0.4
65903090	30-90	3.0	0.9
65903130	45-130	3.0	1.0
65903160	45-160	4.0	2.8
65903210	45-210	4.0	3.0
65903270	65-270	5.0	7.5
65903340	65-340	5.0	8.2

Gear puller - 2 Jaw





65909

Part no.	Size	<i>l</i>	Ton	
	Length			kg
65909090	90	100	3	1.1
65909130	130	100	3	1.3
65909160	160	150	5	3.2
65909200	200	150	5	3.6
65909250	250	200	7.5	7.8
65909350	350	200	7.5	9.2
65909520	520	200	10	15.2
65909640	640	225	15	23.2





Quick-adjusting puller - 2 Arm



65909Q	Jaw open	Reach		
Part no.	mm	mm	Packing	kg
65909090Q	90	100	12/14.0/15.0/0.57'	1.2
65909130Q	130	100	12/15.5/16.8/0.57'	1.3
65909160Q	160	150	6/18.6/19.6/0.56'	3.1
65909200Q	200	150	6/21.3/22.3/0.63'	3.6
65909250Q	250	200	3/21.8/22.8/0.62'	7.3



Gear puller – 3 Arm



65910	Jaw open	Reach		
Part no.	mm	mm	Packing	kg
65910090	90	100	12/17.8/18.8/0.71'	1.5
65910130	130	100	12/19.8/20.8/0.79'	1.7
65910160	160	150	3/12.2/13.2/0.46'	4.1
65910200	200	150	3/13.2/14.2/0.54'	4.4
65910250	250	200	2/18.1/19.1/0.82'	9.1

Quick-adjusting puller - 3 Arm



65910Q	Jaw open	Reach		
Part no.	mm	mm	Packing	kg
65910090Q	90	100	12/18.3/19.3/0.71'	1.5
65910130Q	130	100	12/20.1/21.1/0.79'	1.7
65910160Q	160	150	3/12.3/13.3/0.46'	4.1
65910200Q	200	150	3/13.3/14.3/0.54'	4.4
65910250Q	250	200	2/17.6/18.6/0.82'	8.8

Hydraulic bearing separator puller set



66601  2/15.2/16.2/0.53'  7.6kg

- Contents:**
- 1pc Hydraulic ram (SCM415 Diameter 37.7mm x 160mmL x 16t)
 - 1set Bearing separator & bolts, SCM415, capacity 75-105mm
 - 2pc Main rod (8"x1.75p)
 - 2pc Extension rod (8"x1.75p)
 - 1pc Beam
 - 1pc Central adaptor (ø1" x L30mm)

Pressure screw separator puller set



66602  2/17.3/18.3/1'  8650g

- Contents:**
- 1pc Central bolt
 - 1set Bearing separator & bolts, SCM415, capacity 75-105mm
 - 2pc Main rod (8"x1.75p)
 - 2pc Extension rod (8"x1.75p)
 - 1pc Beam
 - 1pc Central nut
 - 1pc Central extension rod
 - 1pc Central adaptor (ø1" x L30mm)

Two sets bearing separator kit



66610  5/23.0/24.0/1.8'  4.6kg

- 2 sets Bearing separator & bolts (SCM415 Drop forged HRC 42-45)
Capacity: 30-50mm
Capacity: 50-75mm
- 4pc Main/Extension rod (Hex bar 17mm x 127mmL x 3/8" - 16T)
- 4pc Main/Extension rod (Hex bar 14mm x 102mmL x 3/8" - 16T)
- 1pc Beam (S45C)
- 1pc Forcing screw (Φ9/16" - 10T/inch x 175mmL S45C)
- Packing: Blow mold case



Pressure screw separator puller set



66612

2/18.0/19.0/0.5' 9kg

- 1 set Bearing separator & bolts (SCM415 Drop forged HRC 42-45) Capacity: 75-105mm
- 2pc Main rod (Hex bar 19mm x 8"L x Φ 15.24mm - 1.75P)
- 2pc Extension rod (Hex bar 19mm x 8"L x Φ 15.24mm - 1.75P)
- 1pc Beam (S45C)
- 1pc Forcing screw (Φ 18.65 - 10T/inch x 292mmL S45C)
- 1pc Central nut
- Packing: Metal case



Hydraulic bearing separator puller set

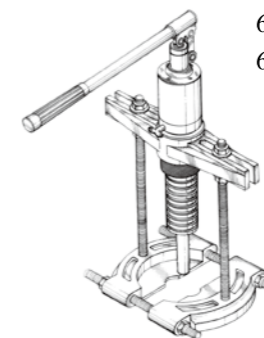

666					
Part no.	Capacity	Reach(mm)	Spread(mm)	Stroke	kg
66605	6 tons	300/190	235/90	82	16
66606	8 tons	300/245	235/90	82	17
66607	10 tons	300/190	235/90	82	16
66608	12 tons	300/245	235/90	82	17

Hydraulic bearing separator puller set



66613

2/24.0/25.0/0.8' 12kg

- 1pc Hydraulic ram (SCM420 Φ 37.7mm)
- 1 set Bearing separator & bolts (SCM415 Drop forged HRC 42-45) Capacity: 105-150mm
- 2pc Main rod (Hex bar 21mm x 10"L x Φ 5/8" - 11 NC)
- 2pc Extension rod (Hex bar 21mm x 10"L x Φ 5/8" - 11 NC)
- 1pc Beam (Ductile)
- 1pc Ram extension rod (Φ 1" x L2")
- 1pc Ram extension rod (Φ 1" x L4")
- 1pc Central adaptor (Φ 1" x 30mm)
- 1pc Step plat puller adaptor (Φ 80 x Φ 63mm)
- Packing: Metal case



Bearing separator



666

Item No.	Capacity	Bolt	Hole
666050	1-1/4" to 2-1/4" (30-50mm)	9.5mm x 125mmL x 3/8" x 24t	8.2mm x 3/8" x 16t
666075	2-1/4" to 3-1/2" (50-70mm)	12.7mm x 135mmL x 1/2" x 20t	8.2mm x 3/8" x 16t
666105	3" to 4-1/2" (75-105mm)	16mm x 165mmL x 5/8" x 18t	11.2mm x 1/2" x 12t
666150	4" to 6" (105-150mm)	19mm x 260mmL x 3/4" x 16t	14.6mm x 5/8" x 11t
666225	35-225	20mm x 255mmL	5/8" x 11P
666300	35-300	26mm x 355mmL	3/4" x 10P

Mini bearing separator assembly



66614

20/12.7/13.7/0.8' 636g

- Bearing separator inside:
- Capacity 3/8"- 1 1/4" (10mm to 30mm)
 - Bolt (6.3mm x 83mmL x 1/4" x 20UNC)
 - Body thread 3/8" x 20UNC



Pull out the bearing with the H-type beam and bolts.

Bearing Separator



666140

4/30.0/31.0/1' 7.5Kg

- Capacity 1.5" to 6" (35-140mm)

Locking jaw puller set



664P  6/13.6/14.6/1.33'  2260g

With several pulling attachments to give the user various methods for pulling, maintenance and repair applications.

Contents:

- 9pc Adjustable reversible jaw
- 1pc Forcing screw
- 1pc Two-way yoke
- 1pc Three-way yoke
- 1pc Reversible adjusting nut
- 3pc Screw & nut



Internal & external puller set



66431  3/16.0/17.0/1.5'  5300g

- Drop forged chrome vanadium steel

Contents:

- 1-Internal small (Capacity: 15-30mm)
- 1-Internal large (Capacity: 30-80mm)
- 1-External (Capacity: 15-80mm)
- 1-Slide shaft
- 1-Slide hammer



Rear Axle puller & external rearing puller set



66432  3/16.0/17.0/1.5'  5300g

- Chrome molybdenum steel external bearing puller with chrome plated & black finish.
- Suitable for rear axle puller & external bearing puller.

Contents:

- 1-Slide screw: 5/8" – 16T X 22-1/2" (16mm – 16T X 57cm)
- 1-External bearing puller capacity from 15-80mm (9/16" – 3-1/2")
- 3-Axle yoke
- 1-Bearing adaptor
- 1-Slide hammer 3-3/4 LB (1.75kg)
- 1-Lock nut 5/8" (16mm)
- 1-Bearing hook

Blind hole bearing puller set



905T6  5/17.5/18.5/1.25'  3650g

- One slide hammer shaft & 4 clamps.
- Adjustable collets make easy removal of bearing or bushings form blind holes.
- Clamps: 1/2" (10-14mm), 5/8" (15-19mm), 13/16"(20-24mm), 1-1/8" (25-32mm)



Blind hole bearing puller



910T1  5/16.5/17.5/1.66'  3500g

- Two function bearing remover for puller and slide hammer.
- One slide hammer, 62mm tailpipe expanders and pullers for 8mm~32mm.



2-in-1 Bearing Puller (2 Jaws)



66621  2/10.7/11.7/0.62'  5400g

- Inside diameter 38mm ~ 120mm

2-in-1 Bearing Puller (3 Jaws)



66620  4/12.4/13.4/1.17'  3050g

- Inside diameter 12mm ~ 38mm



Pilot bearing puller



66619  20/18.3/19/0.8'  920g

- Capacity: inside diameter 12mm-38mm, 1/2"~1-1/2"

Thick jaws gear puller





65910  20/15.0/16.0/1.1'  680g

- Jaws thickness: 1.5 mm
- Depth : 100mm
- Bearing dimension: 40-90mm



Bearing puller



666A	Capacity		
Part no.	mm	g	packing
666A035	19 - 35	280	40/11.2/12.2/1'
666A055	24 - 55	783	24/18.8/19.8/1.4'
666A080	35 - 80	600	20/12.0/13.0/1'



Long jaw bearing puller



66616  24/26.0/27.0/2.6'  1200g

- For long distance pulling jobs
- Capacity 10-50mm
- Alloy steel
- Jaw long 300mm (SCM415 drop forged HRC 40-42)
- Drop forged hardened 48°-50°
- Forcing screw (SCM415)
- Stopper cone (S45C)
- Connector (SCM415)

Bearing separator



66618  20/17.0/18.0/1.5'  800g

- This kit is different from other bearing separators. When obstruction is round external dia. and internal dia. of bearing, it can be used on the confined space to damage the protecting cover of bearing and easily remove bearings.
- Adjust range: 20 ~ 95 mm
- Bearing range:
6004 ~ 6010 (Jaw size: Ø 6 / 8)
6201 ~ 6206 (Jaw size: Ø 5.5 / 6 / 8) ;
6300 ~ 6304 (Jaw size: Ø 6 / 8)



Bearing separator



66618M  12/22.0/23.0/1.3'  1700g

- This kit is different from other bearing separators. When obstruction is round external dia. and internal dia. of bearing, it can be used on the confined space to damage the protecting cover of bearing and easily remove bearings.
- Adjust range: 35 ~ 120 mm
- Bearing range:
 - 6207 ~ 6211 (Jaw size: Ø 11 / 12.5 / 15)
 - 6305 ~ 6308 (Jaw size: Ø 11 / 12.5) ;
 - 6403 ~ 6405 (Jaw size: Ø 11 / 12.5 / 15)

Unique bearing removal kit



66618MA  5/17.0/18.0/1.2'  2700g

- Three-way operation allows use with traditional bearing separator, internal or external legs or bearing race separator. Bearing race separator application makes this kit ideal for use on "blind" mounted bearings where rear of bearing is not accessible.
- Adjust range: 35 ~ 120 mm
- Bearing range: 6207 ~ 6211 (Jaw size: Ø 11 / 12.5 / 15)
6305 ~ 6308 (Jaw size: Ø 11 / 12.5) ;
6403 ~ 6405 (Jaw size: Ø 11 / 12.5 / 15)
- Beam : 30~50 mm
- Legs: 30~90 mm

Differential side bearing puller



666A01  10/22.5/23.5/1.46'  2250g

- Used to removing differential side carrier bearing. Works on a wide variety of cars and light-duty trucks.
- Includes four step plate adapters to fit carrier bearings.

A/C Clutch puller set



666A02  10/22.0/23.0/1.46'  2200g

- Versatile 2-jaw puller designed to remove stubborn A/C clutch pulleys.
- Features two sets of jaws, a crossbar with three settings for correct spread, and an adjustable yoke to keep jaws tight.
- Spread of jaws: 3" to 5". Reach of jaws: 1" to 2-1/4".

21pc Go-through ratchet socket set (SAE&MM)



666A03  5/20.6/21.6/1.3'  4120g

- For a wide range of pulling jobs, including: bearings, alternators, generators, power steering and crankshaft pulleys, timing gears, and harmonic balancers.
- Spread: 2-3/8" to 3-3/8" & 3-1/2" to 5-1/2"
- Reach: 1-5/8" & 1-3/4"
- Set includes drop-forged components, which can be used in a variety of combinations.

Hydraulic gear puller set



66622  1/16.5/17.5/1.2'  16.5kg

- For agriculture/ Machine/ Garage/ Industry use
- Hydraulic ram (SCM420 Ø37.7mm)
 - Twin Head 1pc
 - Triple head 1pc
 - Ram nut (SCM415 HRC 42-45)
 - Beam (S45C)
 - 4" Leg 3 pcs (SCM415 HRC 42-45)
 - 6" Leg 3 pcs (SCM415 HRC 42-45)
 - 8" Leg 3 pcs (SCM415 HRC 42-45)
 - Ram extension rod (Ø1" × L2" S45C)
 - Ram extension rod (Ø1" × L4" S45C)
 - Center adaptor (Ø1" × 30mm)
 - Main rod 2 pc (Hex bar 19mm × L8" × Ø15.24mm-1.75P)
 - Extension rod 2pc (Hex bar 19mm × L8" × Ø15.24mm-1.75P)
 - Bearing separator Spread range 75-150mm (SCM415 Drop forged HRC 42-45)

6 ways multi purpose hydraulic gear puller



66623

5/24.0/25.0/1.3' 4800g

- Hydraulic ram (SCM420 Ø 37.7mm)
- Combination cross head (S45C)
- Combination leg 3pcs (SCM415 Drop forged HRC 42-45)
- Steel Plate 6 pcs
- Screw/ Nut /Washer 6pcs
- Central adaptor (Ø 1" × L30mm S45C)
- Ram Extension rod (Ø1"× L2"S45C)

Micro 3" jaw lock puller



66617

12/12.0/13.0/0.7' 1420g

- Forcing screw (SCM415)
- Chuck (SCM415)
- 3" Jaw 3pieces (SCM415)

Hydraulic 6" jaw lock puller



66617A

4/14.0/15.0/0.7' 5500g

- Hydraulic ram (SCM420)
- Chuck (SCM415)
- 6" Jaw 3pieces (SCM415)

Inside puller



66624

12/19.0/20.0/2' 1600g

- Spread: 23-130 mm
- Depth: 140 mm

Outside puller



66625

12/22.0/23.0/1.6' 1.8kg

- Spread: 7-140 mm
- Depth: 147 mm

Universal puller set



66626

3/20.5/21.3/1.2' 7200g

- 1 beam 2-arm
- 1 beam 3-arm
- 9 pulling legs, length 100 / 200 / 250 mm
- 2 spindle

Universal puller set



66627

2/25.0/26.0/1.25' 12.4kg

- 1 beam 2-arm
- 1 beam 3-arm
- 9 pulling legs, length 150 / 220 / 300 mm
- 1 spindle

2&3 Jaws gear puller set



66628

6/16.5/17.5/0.93' 2.75kg

- 1 beam with 2-arm and 3-arm
- 6 pulling legs, length 130 / 200 mm
- 1 spindle (219mm)

2pc Torque adapter set (for spark plug)



K3021

24/12.0/13.0/0.8' 500g

	2pc	832318	3/8"DR. 18Nm
		832324	3/8"DR. 24Nm

10pc 3/8"DR. Spark plug socket set

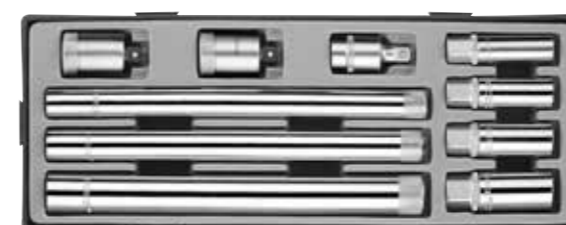

T31010

6/13.7/14.7/0.65' 2278g

	4pc	Magnetic spark plug 14; 16; 18; 20.6 mm	
	3pc	Magnetic spark plug 14; 16; 20.6 mm (250mmL)	
	2pc	18Nm; 24Nm	
	1pc	Extension type (80531E)	

3pc Step wrench set



4031

20/17.0/18.0/1.4' 850g

	1pc	802412	1/2"DR. Square hole ratchet handle
	1pc	68901	Slotted step wrench 1.5x8.9 3/8"(9.35mm); 7/16"(9.75mm); 15/32"(12mm); 1/2"(12.8mm); 35/64"(13.8mm); 3/4"(18.4mm); 27/32"(21.4mm); 7/8"(21.9mm)
	1pc	68902	Hex step step wrench 3/8"; 1/2"; 3/4"; 1"

3pc 1/2"DR. Pentagon socket set





4036

60/14.8/15.8/0.5' 246g

	2pc	650 14...19	Pentagon socket 14; 19 mm
	1pc	65001	Pentagon socket bit 10mm (55mmL)

5pc Fill/Drain plug key set



5051  25/11.5/12.5/0.64'  460g

1pc	5051-1	17mmHex - 14mmHex
1pc	5051-2	10mmHex - 12mmHex
1pc	5051-3	9mmHex - 5/16"Hex
1pc	5051-4	8mmHex - 13mmSq.
1pc	5051-5	3/8"Sq. - 11mmSq.

6pc Fill/Drain plug key set





5061  25/17.9/18.9/0.64'  740g

1pc	5061-1	5/16"Hex - 3/8" Hex
1pc	5061-2	8mmSq. - 3/8"Sq.
1pc	5061-3	11mmSq. - 12mmHex
1pc	5061-4	13mmSq. - 14mmHex
1pc	5061-5	17mmHex - 1/2"Hex
1pc	5061-6	8mmHex - 10mmHex

12pc Auto kit set





5122  6/11.8/12.8/0.9'  1970g

1pc	8074 16M	1/2"DR. Magnetic spark plug 16mm
1pc	807420.6M	1/2"DR. Magnetic spark plug 20.6mm
1pc	5061-1	5/16"Hex - 3/8" Hex
1pc	5061-2	8mmSq. - 3/8"Sq.
1pc	5061-3	11mmSq. - 12mmHex
1pc	5061-4	13mmSq. - 14mmHex
1pc	5061-5	17mmHex - 12"Hex
1pc	5061-6	8mmHex - 10mmHex
1pc	810421	Plug key holder 1/2"(F)x21mm(F)
1pc	617	Telescope mirror stick/magnetic pick-up
1pc	618	20pc feeler gauges 0.05mm to 1mm
1pc	619	Oil filter strap wrench

6pc Brake spanner set





50612  30/17.8/18.8/1.3'  593g

1pc	6080610	1/4"Sq. - 10mmSq.
1pc	6080810	8mmHex - 10mmHex
1pc	6080911	9mmHex - 11mmHex
1pc	6080607	1/4"Hex - 7mmHex
1pc	6081109	7/16"OE - 11/32"Sq.
1pc	6080608	1/4"Sq. - 5/16"OE

Brake spanner





608  

Part no.	Size	l mm	g	pc/box
6080610	1/4"Sq.-10mmSq.	175	82	10
6080608	1/4"Sq.-5/16"OE.	175	84	10
6080810	8mmHex.-10mmHex.	175	82	10
6080911	9mmHex.-11mmHex.	175	87	10
6080607	1/4"Hex.-7mmHex.	175	84	10
6081109	7/16"OE.-11/32"Sq.	175	85	10
6081114	7/16"OE.-9/16"OE.	175	102	10
6081113	11mmOE.-13mmOE.	175	103	10
6081011	10mmOE.-11mmOE.	175	92	10

Rim wrench





677   

Part no.	Size	l mm	g	pc/box	O.D. mm
6771921	19x21	300	1000	5	16
6771924	19x24	300	1020	5	16
6772123	21x23	300	1100	5	16
6772224	22x24	400	1300	5	19
6772427	24x27	400	1320	5	19
6772432S	15/16x1-1/4	400	1330	5	19
6772730	27x30	400	1330	5	19
6772732	27x32	400	1380	5	19
6772733	27x33	400	1400	5	19
6772833	28x33	400	1410	5	19
6773032	30x32	400	1440	5	19
6773033	30x33	400	1440	5	19
6773233	32x33	400	1495	5	19
6773238	32x38	400	1535	5	19
6773821	38x21sq.	400	1520	5	25
6773822	38x22sq.	400	1520	5	25
6774121	41x21sq.	400	1550	2	25
6774121L	41x21sq.	450	1800	1	25

Wrench bar



677  

Part no.	O.D.	l mm	g	packing
67701	19mm	630	1400	15/21/22/0.32'
67702	25mm	630	2420	10/24/25/0.32'
67701400	19mm	400	890	25/22/23/0.2'
67703	16mm	400	630	30/18.9/19.9/0.2'

Foldable cross-handle socket wrench



681		<i>l</i>	
Part no.	packing	length	g
681400	12/17.9/18.9/1.2'	16"(400mm)	1490
681500	10/17.6/18.6/1.1'	20"(500mm)	1760

Socket size: 17mm; 19mm; 21mm; 1/2" square

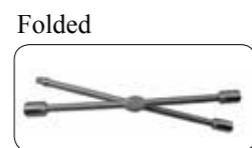

Assembly wheel nut wrench



681A300		20/22.2/23.2/0.63'		1110g
---------	--	--------------------	--	-------

- 17mm; 19mm; 13/16"; 1/2"DR. (300mmL)
- Chrome vanadium alloy steel
- For most car wheel nuts in metric
- Polished, chrome plated



Wheel nut wrench



681B400		12/18.6/19.6/0.97'		1550g
---------	--	--------------------	--	-------

- 17; 19; 21; 22 mm with 1/2"DR. Adapter (400mmL)
- Chrome vanadium alloy steel
- For most car wheel nuts in metric
- Polished, chrome plated



1/2"DR. Quick power wheel nut ratchet handle



681D515		10/23.0/24.0/1.1'		2300g
---------	--	-------------------	--	-------

- Removes stubborn wheel nuts quickly and easily.
- Torque multiplier increases torque by 3.5 by using the lever arm.
- The lever arm should never be used to tighten nuts due to the possibility of over tightening.
- Length: 515 mm



Double power lug wrench



681600		6/20.0/20.5/0.84'		3333g
--------	--	-------------------	--	-------

- Foldable: easy to carry and store.
- Sliding: increase power.
- Deep sockets.
- Socket size: 24/27/32mm & 3/4"SQ.DR.
- Length : 600 mm

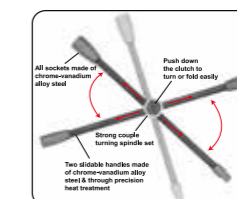

Tyre lever



750		<i>l</i>	
Part no.	packing	mm	g
750200	100/14.6/15.6/0.56'	200	162
750300	120/31.6/32.6/0.6'	300	370
750380	60/22.9/23.9/0.5'	380	556
750380B	60/22.9/23.9/1.2'	380	382
750500	30/22.0/23.0/0.69'	500	732
750525B	30/24.0/25.0/0.69'	525	800
750650	20/23.2/24.2/0.54'	650	1160
750650B	20/21.8/22.8/0.7'	650	1160



Wheel balancing weight tool



6821

30/12.6/13.6/1.3' 420g

- Easily removes and replaces wheel weights, as well as cutting and crimping.
- Made of heat-strengthened steel. Included comfortable vinyl handle grips.
- With self-open function spring on the handle for easier operation.
- Length : 245 mm

VW, AUDI V-belt pulley remover



67402

144/5.0/6.0/1.5' 50g

- Special design to stop the pulley and remove the center bolts to remove the V-belt pulley at the generator.
- Use with 17mm wrench.
- Applicable: VW GOLF, VENTO, PASSAT, AUDI A3 and VOLVO



2pc M10 Alternator tools



674

100/18.2/19.2/1.5' 182g

- 1pc 1/2"DR. Spline (XZN) socket bit M10x110mmL
- 1pc Reaction corkscrew cap 33 teeth-Ø19mm-17mm hex
- Application : VW-Audi, Skoda, Porsche, BMW, Ford, Mercedes-Benz etc.
- Length:110mm



2pc T50 Alternator tools



678

100/21.2/22.2/1.5' 212g

- 1pc 1/2"DR. Torx socket bit T50x110mmL
- 1pc Reaction corkscrew cap 33 teeth-Ø19mm-17mm hex
- Application: Mercedes A Class.
- Length : 110 mm

1/2" Pentagon socket bit 10mm side



65001

Part no.	bit	l mm	g	pc/box
65001		55	94	10

- Application on girling brakes.

1/2"DR. Pentagon socket 14mm / 19mm



65014

65019

65014 / 65019

- 14mm : for pentagon brakes on rear brake, Opel Astra G, Zafira, Smart
- 19mm : for Bendix brakes, Citroën, Peugeot, Renault

1/2"DR. Vacuum switch socket



443

Part no.	size	l mm	g	pc/box
44322	22	85	230	10
44327	27	85	389	10
44315022	22	150	450	10

3/8"DR. Spark plug socket



8073		<i>l</i>		
Part no.	Socket	mm	g	pc/box
807314	14mm	65	65	10
807316	16mm	63	96	10
807318	18mm	63	125	10
807320.6	20.6mm	63	150	10

3/8"DR. Magnetic spark plug socket



8073...M		<i>l</i>		
Part no.	Socket	mm	g	pc/box
807314M	14mm	70	74	10
807316M	16mm	70	80	10
807318M	18mm	70	122	10
807320.6M	20.6mm	70	151	10

3/8"DR. Magnetic spark plug socket (Thin wall)



8073...MTH		<i>l</i>	Diameter		
Part no.	size	mm	mm	g	pc/box
807314MTH	14	70	18	74	10
807316MTH	16	70	19.9	80	10
807318MTH	18	70	23	122	10
807320.6MTH	20.6	70	26	151	10

3/8" DR. Magnetic long spark plug socket



8073250...M		<i>l</i>		
Part no.	Socket	mm	g	pc/box
807325014M	14mm	250	316	10
807325016M	16mm	250	344	10
807325020.6M	20.6mm	250	440	10

1/2" DR. Spark plug socket



8074		<i>l</i>		
Part no.	Socket	mm	g	pc/box
807414	14mm	65	65	10
807416	16mm	65	92	10
807418	18mm	65	133	10
807420.6	20.6mm	65	156	10

1/2" DR. Magnetic spark plug socket



8074...M		<i>l</i>		
Part no.	Socket	mm	g	pc/box
807414M	14mm	70	72	10
807416M	16mm	70	86	10
807418M	18mm	70	146	10
807420.6M	20.6mm	70	148	10

3/8" DR. Universal spark plug socket (ball type)



8073...B		<i>l</i>		
Part no.	Socket	mm	g	pc/box
807316B	16mm	95	114	10
807320.6B	20.6mm	95	150	10

3/8" DR. Universal magnetic spark plug socket (ball type)



8073...BM		<i>l</i>		
Part no.	Socket	mm	g	pc/box
807314BM	14mm	95	90	10
807316BM	16mm	95	118	10
807320.6BM	20.6mm	95	154	10

3/8" DR. Universal spark plug socket (joint type)



8073...U				
Part no.	Socket	l mm	g	pc/box
807316U	16mm	95	114	10
807320.6U	20.6mm	95	150	10

3/8" DR. Universal magnetic spark plug socket (joint type)



8073...UM				
Part no.	Socket	l mm	g	pc/box
807314UM	14mm	95	88	10
807316UM	16mm	95	114	10
807320.6UM	20.6mm	95	150	10

1/2" DR. Universal spark plug socket (joint type)



8074...U				
Part no.	Socket	l mm	g	pc/box
807416U	16mm	95	102	10
807420.6U	20.6mm	95	164	10

1/2" DR. Universal magnetic spark plug socket (joint type)



8074...UM				
Part no.	Socket	l mm	g	pc/box
807416UM	16mm	100	102	10
807420.6UM	20.6mm	100	164	10

3/8" DR. Universal spark T wrench(ball type)



8073...B				
Part no.	Socket	l mm	g	pc/box
807330016B	16mm	300	354	40
807330020.6B	20.6mm	300	392	40
807350016B	16mm	500	552	40
807350020.6B	20.6mm	500	590	40

3/8" DR. Universal magnetic spark T wrench (ball type)



8073...BM				
Part no.	Socket	l mm	g	pc/box
807330016BM	16mm	300	354	40
807330020.6BM	20.6mm	300	392	40
807350016BM	16mm	500	554	40
807350020.6BM	20.6mm	500	592	40

3/8" DR. Universal spark T wrench (joint type)



8073...U				
Part no.	Socket	l mm	g	pc/box
807330016U	16mm	300	354	40
807330020.6U	20.6mm	300	392	40
807350016U	16mm	500	552	40
807350020.6U	20.6mm	500	590	40
807380016U	16mm	800	850	15
807380020.6U	20.6mm	800	888	15

3/8" DR. Universal magnetic spark T wrench (joint type)

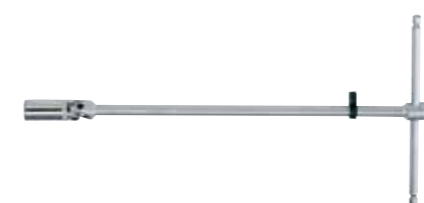

8073...UM				
Part no.	Socket	l mm	g	pc/box
807330016UM	16mm	300	356	40
807330020.6UM	20.6mm	300	394	40
807350016UM	16mm	500	554	40
807350020.6UM	20.6mm	500	592	40
807380016UM	16mm	800	852	15
807380020.6UM	20.6mm	800	890	15

1/2" DR. Universal spark T wrench (joint type)



8074...U		<i>l</i>		
Part no.	Socket	mm	g	pc/box
807430016U	16mm	300	646	30
807430020.6U	20.6mm	300	684	30
807450016U	16mm	500	936	30
807450020.6U	20.6mm	500	974	30
807480016U	16mm	800	1150	15
807480020.6U	20.6mm	800	1188	15

1/2" DR. Universal magnetic spark T wrench (joint type)



8074...UM		<i>l</i>		
Part no.	Socket	mm	g	pc/box
807430016UM	16mm	300	356	30
807430020.6UM	20.6mm	300	394	30
807450016UM	16mm	500	554	20
807450020.6UM	20.6mm	500	592	20
807480016UM	16mm	800	852	15
807480020.6UM	20.6mm	800	890	15

5pc Spark plug rethreader set



64101 72/10.4/11.4/0.9' 144g

- Repairing stripped or damaged threads in aluminum cylinder heads.
- Solid steel inserts replace damaged threads.

Content:

1pc 14mm Spark plug rethreader
4pc inserts 3/8"; 7/16"; 1/2"; 3/4" long



Spark plug gauge



63008 288/5.5/6.5/0.5' 26g

- This popular solid steel spark plug gauge is designed with a tapered edge for gauging spark plugs and with a flanged hole to adjust the side wire of plugs without pressuring center electrode. Marked in standard and metric sizes.
- Size range: 0.020" to 0.100" (0.5mm to 2.53mm)



Three-legged oil filter wrench



61904 36/21.3/22.3/1.2' 590g

- Removes all oil filters from 2-1/2" to 4-5/16" (65mm to 110mm) in diameter.
- Used with 3/8" square drive tools.



Three-legged two way oil filter spiral wrench



61904A 36/15.0/16.0/1.2' 415g

- Fits 1/2" & 3/8" Square Drive Ratchet Handle
- Operated By 21 mm Hex Adaptor: 1/2" Sq. X 3/8" Sq.
- All Chrome Plated. 3-Leg Two Way Operated Range: 63 ~ 102 mm.



Three-legged oil filter wrench



61913 24/24.0/25.0/1.1' 950g

- 3-leg, 1-way, fit 1/2" square drive
- Capacity 75 ~ 130mm (3" to 5-1/8")

Oil filter strap wrench



619		<i>l</i>	
Part no.	Packing	mm	g
619	60/18.7/19.7/3'	150	310

It can match with various tools for use 1/2" driver, pliers and screwdriver.



Truck strap oil filter wrench



61902  48/17.9/18.9/1.4'  372g

- The heavy-duty strap can handle any filter up to 6"(150mm) diameter.
- The support pad helps the grip of the filter without crushing it.
- The more leverage applied, the tighter it grips.
- Use with any 1/2" power bar.
- Capacity: 6"(150mm).



Strap oil filter wrench (1/2" DR. & 3/8" DR.)



61903  40/16.3/17.3/2.8'  408g

- This robust quality strap wrench is capable of removing filters up to 300mm diameter on cars, vans and trucks.
- The design of this wrench makes it ideal for areas where clearance is restricted.
 - The dual drive allows you more flexibility. Besides, the wrench can be used in conjunction with a 13/16"(21mm) open spanner.

Strap oil filter wrench



61908  48/16.2/17.2/2.2'  338g

- With non-slip rubber-fabric strap
- Especially suitable for plastic pipes
- Strap length: 420 mm
- Capacity: 130 mm diameter

Strap wrench



61912  50/16/17/1.6'  320g

- 12" Aluminum handle
- 34" Strap

Adjustable oil filter wrench





61909  50/17.5/18.5/4.83'  350g

- Capacity: 80-110 mm diameter

Swivel handle oil filter wrench



61906 Part no.	 Packing	<i>l</i> mm	 g
61906073	36/12.0/13.0/2.6'	2-3/8" to 2-7/8" (60mm - 73mm)	335
61906085	36/13.4/14.4/2.6'	2-7/8" to 3-3/8" (73mm - 85mm)	372
61906095	36/14.0/15.0/2.6'	3-3/8" to 3-3/4" (85mm - 95mm)	389
61906111	36/14.7/15.7/2.6'	3-3/4" to 4-3/8" (95mm - 111mm)	408

Oil filter wrench

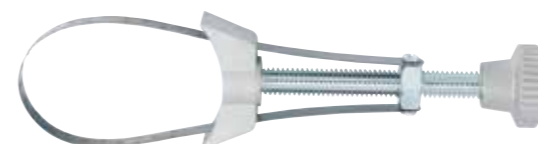

61910 Part no.	Capacity mm	 g
61910	65-110	210
61910L	110-155	230

- Spare diecast (band) available, 61910-D/61910L-D
- Spring steel strip
- Aluminium diecast

Chain oil filter wrench (1/2" DR.)



61901  72/18.9/19.9/2.6'  262g

- 1/2" sq. driver or 13/16"(21mm) open end spanner.
- Suitable for filters up to 120mm diameter.

Chain locking pliers



61901A  20/16.5/17.5/1.1'  825g

- Cr-Mo jaw and handle
- Welded with a 18" chain

Filter chain wrench

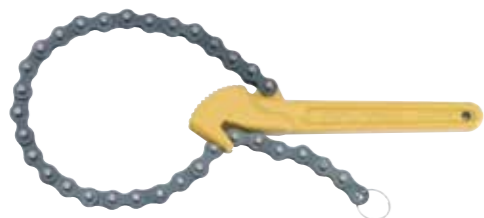

61911  60/22.0/23.0/0.82'  410g

- Suitable for filter up to 40mm - 120mm diameter.

20" Chain wrench





61914  20/20.0/21.0/0.78'  1kg

- 20" chain

Oil filter pliers





639 Part no.	Size mm	 Packing	<i>l</i> inch	 g
639250	60-90	60/21.2/22/2.1'	10	354
639300	85-115	60/22.7/23.7/2.5'	12	379
639365	100-140	20/11/12/1.1'	14	550



Oil filter master pliers



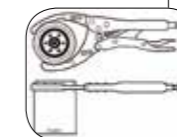

639230 Part no.	Size mm	 Packing	<i>l</i> mm	 g
639230	53-118	40/19.5/20.5/1.7'	230	480



Piston ring compressor





620 Part no.	mm	<i>l</i> inch	 Packing	 g
6202080	40-80	2	50/7.8/8.8/1'	156
6203125	53-125	3	50/15.5/16.5/1.3'	310
6203175	90-175	3	50/17.9/18.9/1.3'	365
6204125	90-125	4	50/16.7/17.7/1.3'	335
6204175	90-175	4	50/18.9/19.9/1.3'	380
6206175	90-175	6	20/12.0/13.0/1.6'	600



Piston ring pliers



623 Part no.	 Packing	<i>w</i> mm	<i>l</i> inch	 g
62301	50/15.0/16.0/2.2'	55-100	3	330
62302	50/18.5/19.5/3'	110-160	3	420
62303	50/8.5/9.5/2.2'	80-120	2.5	170

- **62302** is applied to truck.



Valve spring compressor



62102  12/19.6/20.6/1'  1630g

- For overhead cam engines, specially designed for O.H.C. engines.
- Jaw opening 60-155mm, Throat clearance 150mm.



Valve spring compressor



62103

10/12.2/13.2/0.5' 1220g

- For small and medium engines.
- Jaw opening 68-130mm, Throat clearance 150mm.



Valve spring compressor



62104

6/15/16/0.9' 2650g

- For multi-valve petrol and diesel engines, specially designed for difficult access and deep-seated multi-valve cylinder heads.
- Jaw opening 45-145mm, Throat clearance 240mm.



Valve spring compressor



62106

24/17.8/18.8/2.1' 740g

- Compresses overhead valve springs with rocker arm studs.
- This tool can be used with the head either on or off the engine.
- Jaws adjust to fit most overhead valve engines.
- Adjustable handle allows for clearance in tight areas.



Flat band hose clamp pliers



62518

72/18.0/19.0/2.6' 250g

- Removes and installs new style flat band hose clamps.
- Jaws rotate to grip at any angle.



Angled flat band hose clamp pliers



62522

48/10.9/11.9/2.7' 227g

- Designed to remove and install flat band hose clamps in hard-to-reach areas. Pliers feature angled jaws with rotating tips to grip clamps at any angle. Locking latch securely holds clamp in position.



CV Boot clamp pliers



62519

72/24.7/25.7/2.6' 320g

- A sturdy tool, works on earless-type clamps including those found on GM inboard CV joint.



CV Joint boot clamp pliers



62520

48/18.2/19.2/1.5' 380g

- For ear type clamps, fits late model GM CV joint boots, also installs PERMA-QUICK type clamps quickly and easily use for filter, cooling system and vacuum lines.



C.V. joint banding tool (with cutter)



62525

72/20.5/21.5/2.5' 285g

- Tool is easily removed by sliding sideways after winding has been completed.



Coil spring compressor



627		<i>l</i>	
Part no.	packing	mm	g
627270	10/18.3/19.3/1'	270	1830
627370	10/21.7/22.7/1.5'	370	2170

- Coil spring compressor made by forging and easy to use.
- Sold and packed in pair.

Ball joint separator



62801		<i>l</i>	
	20/24.4/25.4/1.3'		1220g

- Heat treated drop forged steel body & bolt for long rough usage.
- Spread ball joints easily where space prevents use of direct action method.
- Jaws open: 19mm

Ball joint separator



62802		<i>l</i>	
	20/21/22/1'		1050g

- For splitting track-rod ends, anti-roll bar mountings, ball joints, etc.
- Jaw open: 20mm

Ball joint separator



62805		<i>l</i>	
	20/26.2/27.2/1.1'		1310g

- This universal tie rod end remover will work on most cars and light trucks.
- The necessary force needed to remove tie rod end is easily applied through the center pivot action.
- Fork opening: 20mm
- Reach: 20mm-50mm
- Suitable for: VW-AUDI, BMW, FIAT, FORD, MERCEDES, NISSAN, OPEL, PEUGEOT, RENAULT, ROVER, SAAB, TOYOTA, VOLVO.

Ball joint extractor



62806		<i>l</i>	
	12/18.2/18.7/0.96'		1620g

- For splitting track-rod ends, anti-roll bar mountings, wheel-hub ball joints, etc.
- Jaw open: 22mm
- 2-Stage, 50-80mm.

Tie rod end & pitman arm puller for compact cars



62811		<i>l</i>	
	20/8.9/9.9/0.46'		445g

- For the safe easy removal of pitman arm assembly from compact automobiles.
- Forged, heat-treated yoke with extra heavy center screw
- Opening: 1-1/16"(27mm)
- Pull: 1-3/4"(45mm)

Tie rod end & pitman arm puller



62812		<i>l</i>	
	24/19.1/20.1/0.79'		795g

- Redesigned heavy duty tool to be used to remove pitman arms from late model cars and light trucks
- Yoke is forged from high grade alloy steel and heat-treated.
- Opening: 1-5/16"(33mm)
- Pull: 2-1/2"(64mm)

Ball joint extractor



628E	Open		
Part no.	size	packing	g
628E18	18mm	60/19.0/20.0/1.2'	316
628E23	23mm	30/16.0/17.0/0.99'	533
628E29	29mm	20/17.6/18.6/0.9'	880
628E40	40mm	12/18.6/19.6/0.97'	1550
628E46	46mm	12/21.0/22.0/1.1'	1750

For splitting track-rod ends, anti-roll bar mountings, ball joints etc.

Ball joint separator



Part no.	Open size	l mm	packing	g
628300	15/16"	300	25/17.0/18.0/0.38'	680
628400	21/32"	400	20/19.0/20.0/0.38'	950

- Tempered drop forged steel one piece construction for long & rough usage.
- Replacing worn out ball joints easily with a hammer striking.
- **628300** also can separate shock absorber links.
- **628400** also can remove CV drive shafts on FWD vehicles
- Material:SCM440.



5pc Tie rod ball joint separator set



905T2  10/20.0/21.0/1.46'  2kg

Made from heat treated drop forged steel.

Contents:

- 1pc Tie rod separator Opening: 17mm (11/16")
- 1pc Ball joint separator Opening: 24mm(15/16")
- 1pc Pitman arm wedge Opening: 28mm(1-1/8")
- 1pc Handle with lock nut 8"(200mm)
- 1pc Pneumatic handle 7"(180mm)



Brake caliper tool



65803  30/21/22/0.9'  700g

- For rewinding the piston in all collets type disc brake calipers with built-in parking mechanism.
- Essential for fast and easy pad replacement and caliper servicing.
- Suitable for: FORD, HONDA, JAGUAR, MAZDA, MITSUBISHI, NISSAN, ROVER, SUBARU, TOYOTA, with ABS.



7pc Brake caliper piston tools set



658  12/16.3/17.3/1.3'  1360g

- Kit comprises main body, screw assembly, special locating plate and 5 adaptors covering wind-back.
- Applicable: VW, AUDI, FORD, PEUGEOT, ROVER, NISSAN, SUBARU, HONDA, BMW, MITSUBISHI, TOYOTA, JAGUAR, MERCEDES, MAZDA.



13pc Disc brake park caliper tools set

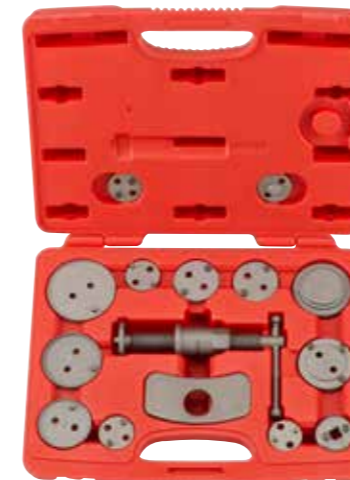

65802  10/20.1/21.1/1.8'  2kg

- For rotating pistons back into the caliper to provide clearance for new pads. Include 11 adaptors (available individually) for use in both 2 and 4-wheel rear disc brake assemblies of most domestic and import cars. The tool may be used "on" and "off" the car.
- Suitable for: MERCEDES, BMW, VW, GM,AUDI, FORD, HONDA, SUBARU, MAZDA, NISSAN,MITSUBISHI, TOYOTA, ROVER, 4WD, OPEL,RENAULT.



18pc Universal caliper wind back kit

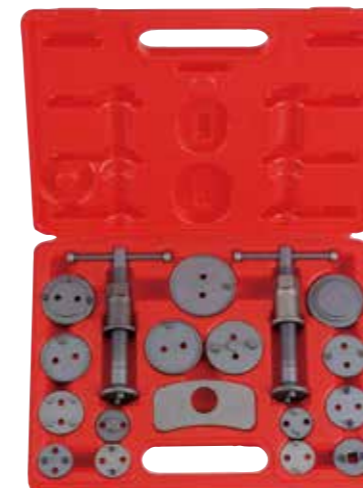

65805  10/25.5/26.5/1.87'  2417g

- Two bodies with positive thread and negative thread for different vehicles.
- With one plate and fifteen adaptors to fit most of the cars.
- Applicable: Citroen, AUDI, FIAT, FORD, ISUZU, HONDA, JAGUAR, BMW, NISSAN, MITSUBISHI, VW, SAAB, MAZDA, TOYOTA...etc.



Auto body repair pull clamp



62501  10/19.4/20.4/0.6'  1940g

- Single direction action
- Capacity: 5 tons



Auto body repair pull clamp (two way)



62502  10/21.0/22.0/0.6'  2100g

- Two direction action
- Cross capacity: 2 tons
- Longitudinal capacity: 5 tons

Auto body repair pull clamp



62503  10/20.1/21.1/0.65'  2kg

- Single direction action
- Capacity: 3 tons

Auto body repair pull clamp

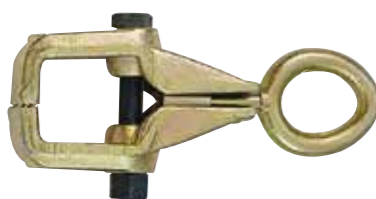

62504  10/20.1/21.1/0.88'  2kg

- Single direction action
- The two side heights of jaw surface are not even, most suitable for narrow space application.
- Capacity: 3 ton

Auto body repair pull clamp (two way)



62505  10/20.1/21.1/0.94'  2kg

- Two direction action
- The two side heights of jaw surface are not even, most suitable for narrow space application.
- Cross capacity: 2 ton
- Longitudinal capacity: 3 ton

Long nose pull clamp



62509  10/16.6/17.6/0.67'  1660g

- Single direction action.
- Long jaw mouth is most suitable for narrow space application.
- Capacity: 1 ton

Auto body repair pull clamp (two way)

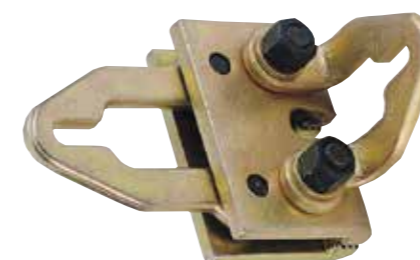

62512  6/17.3/18.3/0.71'  2880g

- Two direction action.
- The jaw surface is long 120mm, most suitable for thin sheet application.
- Cross capacity: 3 ton
- Longitudinal capacity: 5 ton

1 ton Portable puller

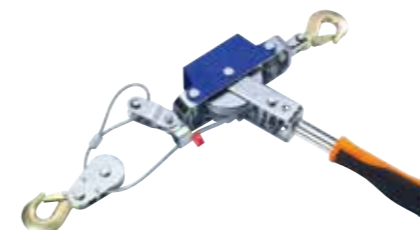

88201  6/20.4/21.9/2.0'  3400g

- Detachable Handle with ergonomic design.
- Stores in a handy case and easily under a pick-up seat or straps to a luggage carrier.
- Capacity: 1 ton (2000 lbs)
- Cable: 5mm x 10ft with 2 hooks

Multi-function powerful suction cup



Part no.	Application	Packing	Capacity	
			Kgs	g
63401	On flat object	20/7.9/5.9/1.6'	50	395
63404	Fixed 2 sucker	20/24.3/25.3/4'	80	1215

- To pull up the plating notched part.
- To fix the windows while maintaining.
- To assemble the front and rear wind broken glasses.



Multi-function powerful suction cup (Aluminum)



634...A			Capacity	
Part no.	Application	Packing	Kgs	g
63401A	On flat object	20/10.9/11.9/1.6'	30	480
63403A	Fixed 2 sucker	20/20.1/21.1/4'	50	780
63404A	Flexible 2 sucker	20/24.4/25.4/4'	35	1180
63405A	Fixed 3 sucker	10/14.1/15.1/3.1'	100	1410

- To pull up the plating notched part.
- To fix the windows while maintaining.
- To assemble the front and rear wind broken glasses.

Adjustable body file blade holder



65701		Application: for 14" (350mm) flexible file adjustable frame.	
	20/15.7/16.7/2.1'		785g

Body file blade



65714		<i>l</i>		Capacity	
Part no.	teeth per inch	inch	Packing	Kgs	g
6571409	9	14	60/18.6/19.6/0.5'	310	
6571412	12	14	60/21/22/0.5'	350	

5pc Auto body tools



T905M2			Capacity	
	6/5.0/6.0/0.6'			836g
	1pc	905M2P1	Trim pad remover (big)	
	1pc	905M2P2	Trim pad remover (small)	
	1pc	905M2P3	Gasket scraper	
	1pc	905M2P4	Radiator hose remover	
	1pc	905M2P5	Cotter pin puller	

5pc Handy remover set

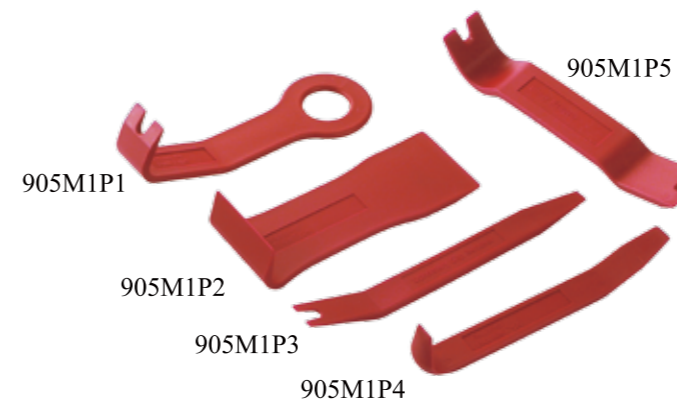

905M1			Capacity	
	24/9.0/10.0/2.7'			336g
<ul style="list-style-type: none"> • For plastic upholstery fastener. • Place tool under edge of door panel and insert into fastener as far as possible and then simply pull up. 				

Contents:

1pc Pull type remover	(905M1P1)
1pc Wide type remover	(905M1P2)
1pc Upholstery clip remover	(905M1P3)
1pc Narrow type remover	(905M1P4)
1pc Handy remover	(905M1P5)





4pc Trim removal set







904M3			Capacity	
	72/6.9/7.9/1'			200g
<ul style="list-style-type: none"> • The most versatile body/interior tool set we have ever carried. Nearly indestructible, non-marring composite construction. • Great for technicians, body shops, upholstery shops. 				
Contents:				
1pc Pointer-pointed side trim removal tool	(904M3P1)			
1pc Spreader trim removal tool	(904M3P2)			
1pc Viper's tongue - lever side trim removal tool	(904M3P3)			
1pc Ski side trim removal tool	(904M3P4)			

4pc Hook & pick set





904U4  60/18.5/19.5/2.5'  309g

	1pc	904U4P1	Full hook
	1pc	904U4P2	90° hook
	1pc	904U4P3	Angel hook
	1pc	904U4P4	Straight pick

Brass & nylon scrape brushes





9U3001  240/8.7/9.7/2'  36g

- Length: 3"(75mm)

5pc Mini pick and hook set





905G6  192/8.6/9.6/1.2'  44g

- Miniature pick set.
- Removes O-rings in line connections and inside compressors.
- Aluminum handles with 4 stainless tools:
 1. awl end
 2. hook end
 3. 45° bent tip
 4. 90° bent tip



Wire brush





9U3003  120/7.7/8.7/2.5'  64g

- Length: 8.7"(220mm)

Brush Assortment



938U1  4/5.8/6.8/1'  1458g



- For professional cleaning and deburring of cylinders, tubes, bushings, etc.
- Also for use on electric and air-powered drills.

Contents:

- 12pc Nylon brushes:
 - Ø 8-9-10-11-12-13-14-15-16-17-18-19 mm (938U1-N 08...19)
- 12pc Steel brushes:
 - Ø 8-9-10-11-12-13-14-15-16-17-18-19 mm (938U1-S 08...19)
- 12pc Brushes with brass coating:
 - Ø 8-9-10-11-12-13-14-15-16-17-18-19 mm (938U1-B 08...19)
- 1pc 1/4" handle with adapter and quick lock (8148)
- 1pc Magnetic QR 1/4"Hex-1/4"Hex 6"(150mm) (812150Q)

6pc Flare nut wrench set





5066  30/18.7/19.7/1.3'  623g

	6pc	8x10; 10x11; 10x12; 11x13; 12x14; 17x19 mm
---	-----	--

8pc Flare nut wrench set





5082  6/14.5/15.5/0.9'  2415g

	8pc	8x10; 11x13; 12x14; 16x18; 17x19; 19x22; 24x27; 30x32 mm
---	-----	--

6pc Flare nut wrench set (SAE)





5066S  30/23.0/24.0/1.5'  766g

	6pc	5/16"x3/8"; 3/8"x7/16"; 7/16"x1/2"; 1/2"x9/16"; 5/8"x3/4"; 11/16"x3/4"
---	-----	--

7pc Flare nut wrench set (SAE)





T50710  6/7.2/8.2/0.72'  1193g

	7pc	5/16"x3/8"; 3/8"x7/16"; 7/16"x1/2"; 1/2"x9/16"; 5/8"x3/4"; 11/16"x3/4"; 3/4"x7/8"
---	-----	---

9pc Ratchet flare nut wrench set







T50918  6/8.1/9.1/0.66'  1350g

	9pc	8; 10; 11; 12; 13; 14; 17; 19; 22 mm
---	-----	--------------------------------------

11pc 3/8"DR. Crowfoot flare nut wrench set







51110  30/22.0/23.0/1.3'  730g

	10pc	10; 11; 12; 13; 14; 15; 16; 17; 18; 19 mm
	1pc	Locking 6"(150mm)

17pc Crowfoot flare nut wrench set







5172  6/12.9/13.9/0.9'  2150g

	12pc	3/8"DR. 10; 11; 12; 13; 14; 15; 16; 17; 18; 19; 21; 22 mm
	3pc	1/2"DR. 23; 24; 26 mm
	2pc	Locking 3/8"DR. 6"(150mm); 1/2"DR. 5"(125mm)

13pc Crowfoot flare nut wrench set (SAE)





5135S  6/12.0/13.0/0.9'  2000g

	9pc	3/8"DR. 3/8"; 7/16"; 1/2"; 9/16"; 5/8"; 11/16"; 3/4"; 13/16"; 7/8"
	2pc	1/2"DR. 15/16"; 1"
	2pc	Locking 3/8"DR. 6"(150mm); 1/2"DR. 5"(125mm)

7pc Hinged socket wrench set





5074  6/13.0/14.0/0.9'  2165g

	7pc	6x7; 8x9; 10x11; 12x13; 14x15; 16x17; 18x19 mm
---	-----	--

3pc Hinged socket wrench set



5033  6/15.0/16.0/0.9'  2500g

	3pc	20x22; 21x23; 24x27 mm
---	-----	------------------------

6pc Hinged socket wrench set (SAE)



50616S		6/19.0/20.0/0.9'		3170g
	6pc	3/8"x7/16"; 1/2"x9/16"; 5/8"x11/16"; 3/4"x7/8"; 13/16"x7/8"; 15/16"x1"		

7pc Hinged star socket wrench set



5075		6/12.5/13.5/0.9'		2080g
	7pc	E4xE5; E6xE7; E8xE10; E11xE12; E14xE16; E18xE20; E22xE24		

11pc Angle 6pt.-6pt. socket wrench set



T5114		6/16.5/17.5/0.8'		2750g
	11pc	8; 10; 11; 12; 13; 14; 15; 16; 17; 18; 19 mm		

17pc Angle 6pt.-6pt. socket wrench set



5176		3/21.0/22.0/1.5'		7000g
	17pc	8; 9; 10; 11; 12; 13; 14; 15; 16; 17; 18; 19; 20; 21; 22; 23; 24 mm		

8pc Rod-type angle socket wrench set



50829		4/18.4/19.4/1.17'		4400g
	8pc	8; 10; 11; 12; 13; 15; 17; 19 mm		

6pc Double open end wrench set



5067D		20/12.6/13.6/0.8'		630g
	6pc	8x9; 10x11; 12x13; 14x15; 16x17; 18x19 mm		

8pc Double open end wrench set



5084		10/9.6/10.6/0.88'		960g
	8pc	6x7; 8x9; 10x11; 12x13; 14x15; 16x17; 18x19; 20x22 mm		

8pc Double open end wrench set



5084-24		10/9.8/10.8/0.69'		976g
	8pc	6x7; 8x9; 10x11; 12x13; 14x15; 16x17; 18x19; 22x24 mm		

10pc Double open end wrench set



5103		10/20.3/21.3/1.6'		2030g
	10pc	6x7; 8x9; 10x11; 12x13; 14x15; 16x17; 18x19; 20x22; 24x27; 30x32 mm		

10pc Double open end wrench set

NEW



51025C

10/18.0/19.0/0.98' Δ 1802g

	10pc	6x7; 8x10; 9x11; 12x14; 13x15; 16x18; 17x21; 19x22; 24x27; 30x32 mm
---	------	--

11pc Double open end wrench set



5111

6/12.0/13.0/0.8' Δ 2100g

	11pc	6x7; 8x9; 10x11; 12x13; 14x15; 16x17; 18x19; 20x22; 21x23; 24x27; 30x32 mm
---	------	---

12pc Double open end wrench set



5128C

10/23.8/24.8/1.3' Δ 2382g

	12pc	6x7; 8x9; 10x11; 12x13; 14x15; 16x17; 18x19; 20x22; 21x23; 24x27; 25x28; 30x32 mm
---	------	--

6pc Double open end wrench set (SAE)

NEW



5067DS

20/16.0/17.0/0.8' Δ 800g

	6pc	1/4"x5/16"; 3/8"x7/16"; 1/2"x9/16"; 5/8"x11/16"; 3/4"x25/32"; 7/8"x15/16"
---	-----	--

9pc Double open end wrench set (SAE)

NEW



50925SC

10/19.3/20.3/1.2' Δ 1932g

	9pc	1/4"x5/16"; 3/8"x7/16"; 1/2"x9/16"; 9/16"x5/8"; 11/16"x25/32"; 3/4"x13/16"; 7/8"x15/16"; 1"x1-1/8"; 1-1/16"x1-1/4"
---	-----	--

10pc Double open end wrench set (SAE)

NEW



5103AS

10/21.0/22.0/1.6' Δ 2100g

	10pc	1/4"x5/16"; 5/16"x3/8"; 3/8"x7/16"; 1/2"x9/16"; 9/16"x5/8"; 11/16"x25/32"; 3/4"x13/16"; 7/8"x15/16"; 1"x1-1/8"; 1-1/16"x1-1/4"
---	------	--

5pc Combination wrench set



T5052

6/14.7/15.7/0.8' Δ 2450g

	5pc	26; 27; 28; 30; 32 mm
---	-----	-----------------------

6pc Jumbo combination wrench set

NEW



50651

4/25.0/26.0/1.5' Δ 6240g

	6pc	32; 34; 36; 38; 41; 46 mm
---	-----	---------------------------

50651A

4/25.6/26.6/1.5' Δ 6400g

	6pc	33; 34; 36; 38; 41; 46 mm
---	-----	---------------------------

7pc Combination wrench set





5077

20/17.8/18.8/0.88' Δ 890g

	7pc	10; 12; 13; 14; 17; 19; 21 mm
---	-----	-------------------------------

8pc Combination wrench set





5086  20/19.8/20.8/1.1'  991g

	8pc	10; 11; 12; 13; 14; 17; 19; 22 mm
---	-----	-----------------------------------

9pc Combination wrench set





5094  10/12.0/13.0/1'  1200g

	9pc	8; 10; 11; 12; 13; 14; 15; 17; 19 mm
---	-----	--------------------------------------

11pc Combination wrench set





5115  12/17.5/18.5/1'  1430g

	11pc	8; 10; 11; 12; 13; 14; 15; 17; 19; 21; 22 mm
---	------	--

12pc Combination wrench set





5121C  10/16.6/17.6/1.2'  1660g

	12pc	8; 10; 11; 12; 13; 14; 15; 16; 17; 19; 22; 23 mm
---	------	--

12pc Combination wrench set





5123  10/16.5/17.5/1.1'  1650g

	12pc	8; 10; 11; 12; 13; 14; 15; 16; 17; 18; 19; 22 mm
---	------	--

14pc Combination wrench set

NEW





5141K  6/19.9/20.9/0.97'  3316g

	14pc	8; 10; 11; 12; 13; 14; 15; 16; 17; 18; 19; 21; 22; 24 mm
---	------	--

16pc Combination wrench set





5161  6/13.8/14.8/0.9'  2283g

	16pc	6; 7; 8; 9; 10; 11; 12; 13; 14; 15; 16; 17; 18; 19; 22; 24 mm
---	------	---

17pc Combination wrench set

NEW





51710C  10/23.0/24.0/1.2'  2302g

	17pc	6; 7; 8; 9; 10; 11; 12; 13; 14; 15; 16; 17; 18; 19; 21; 22; 24 mm
---	------	---



19pc Combination wrench set



5191C		10/27.5/28.5/1.3'	 2750g
	19pc	6; 7; 8; 9; 10; 11; 12; 13; 14; 15; 16; 17; 18; 19; 20; 21; 22; 23; 24 mm	

14pc Combination wrench set





5141C		6/19.9/20.9/0.97'	 3180g
	14pc	10; 11; 12; 13; 14; 17; 19; 21; 22; 23; 24; 27; 30; 32 mm	

16pc Combination wrench set

NEW





51612C		6/23.4/24.4/1.4'	 3900g
	16pc	10; 11; 12; 13; 14; 15; 16; 17; 18; 19; 21; 22; 24; 27; 30; 32 mm	

21pc Combination wrench set

NEW





5213C		6/29.9/30.9/1.8'	 4988g
	21pc	6; 7; 8; 9; 10; 11; 12; 13; 14; 15; 16; 17; 18; 19; 21; 22; 24; 27; 30; 32; 36 mm	

22pc Combination wrench set



NEW



5221C		4/19.5/20.5/0.98'	 4875g
	22pc	6; 7; 8; 10; 11; 12; 13; 14; 15; 16; 17; 18; 19; 20; 21; 22; 23; 24; 26; 27; 30; 32 mm	



26pc Combination wrench set



5261C		3/16.2/17.2/1'	 5400g
	26pc	6; 7; 8; 9; 10; 11; 12; 13; 14; 15; 16; 17; 18; 19; 20; 21; 22; 23; 24; 25; 26; 27; 28; 29; 30; 32 mm	

26pc Combination wrench set





5261		3/24.6/25.6/3.6'	 8200g
	26pc	6; 7; 8; 9; 10; 11; 12; 13; 14; 15; 16; 17; 18; 19; 20; 21; 22; 23; 24; 25; 26; 27; 28; 29; 30; 32 mm	

6pc Jumbo combination wrench set (SAE)

NEW



50651S		4/22.5/23.5/1.5'	 5423g
	6pc	1-1/4"; 1-5/16"; 1-3/8"; 1-7/16"; 1-1/2"; 1-5/8"	

7pc Combination wrench set (SAE)



5077S		20/15.5/16.5/0.88'		780g
	7pc	3/8"; 7/16"; 1/2"; 9/16"; 5/8"; 11/16"; 3/4"		

8pc Combination wrench set (SAE)



5086S		20/17.3/18.3/1.1'		865g
	8pc	3/8"; 7/16"; 1/2"; 9/16"; 5/8"; 11/16"; 3/4"; 13/16"		

11pc Combination wrench set (SAE)



5115S		12/17.2/18.2/1'		1460g
	11pc	1/4"; 5/16"; 3/8"; 7/16"; 1/2"; 9/16"; 5/8"; 11/16"; 3/4"; 13/16"; 7/8"		

12pc Combination wrench set (SAE)



5121SC		10/16.6/17.6/1.2'		1660g
	12pc	1/4"; 5/16"; 3/8"; 7/16"; 1/2"; 9/16"; 5/8"; 11/16"; 3/4"; 13/16"; 7/8"; 15/16"		

13pc Combination wrench set (SAE)



5134		6/14.1/15.1/0.9'		2350g
	13pc	1/4"; 5/16"; 3/8"; 7/16"; 1/2"; 9/16"; 5/8"; 11/16"; 3/4"; 13/16"; 7/8"; 15/16"; 1"		

14pc Combination wrench set (SAE)



5141SC		6/18.0/19.0/1.2'		3000g
	14pc	5/16"; 3/8"; 7/16"; 1/2"; 9/16"; 5/8"; 11/16"; 3/4"; 13/16"; 7/8"; 15/16"; 1"; 1-1/8"; 1-1/4"		

16pc Combination wrench set (SAE)

NEW



5162SP		6/20.5/21.5/0.97'		3420g
	16pc	1/4"; 5/16"; 3/8"; 7/16"; 1/2"; 9/16"; 5/8"; 11/16"; 3/4"; 13/16"; 7/8"; 15/16"; 1"; 1-1/16"; 1-1/8"; 1-1/4"		

20pc Combination wrench set (SAE)

NEW



5209SC		10/22.3/23.3/1.3'		2135g
	20pc	5/32"; 3/16"; 7/32"; 1/4"; 9/32"; 5/16"; 11/32"; 3/8"; 13/32"; 7/16"; 15/32"; 1/2"; 9/16"; 5/8"; 11/16"; 3/4"; 13/16"; 7/8"; 15/16"; 1"		

20pc Combination wrench set (SAE)

NEW



52010S		3/32.1/33.1/3.3'		10.7kg
	20pc	1/4"; 5/16"; 3/8"; 7/16"; 1/2"; 9/16"; 5/8"; 11/16"; 3/4"; 13/16"; 7/8"; 15/16"; 1"; 1-1/16"; 1-1/8"; 1-1/4"; 1-5/16"; 1-3/8"; 1-7/16"; 1-1/2"		

19pc 75° Offset combination wrench set



5192		19pc	8/25.4/26.4/2.3'		3175g
			6; 7; 8; 9; 10; 11; 12; 13; 14; 15; 16; 17; 18; 19; 20; 21; 22; 23; 24 mm		

19pc Spline combination wrench set



5191Q		19pc	10/24.5/25.5/1.2'		2450g
			M6; M7; M8; M9; M10; M11; M12; M13; M14; M15; M16; M17; M18; M19; M20; M21; M22; M23; M24		

13pc Extra long combination wrench set



51313		13pc	4/13.4/14.4/1.17'		3360g
			8; 10; 11; 12; 13; 14; 15; 16; 17; 18; 19; 22; 24 mm		

4pc Star wrench set

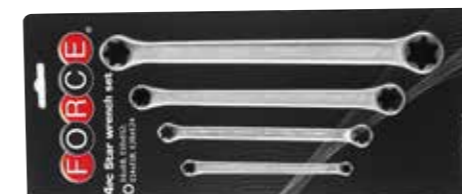

5041		4pc	60/21.1/22.1/1.7'		350g
			E6xE8; E10xE12; E14xE18; E20xE24		

12pc Midget combination wrench set



51214		12pc	6/9.1/10.1/0.9'		1516g
			8; 9; 10; 11; 12; 13; 14; 15; 16; 17; 18; 19 mm		

6pc Star wrench set



5062		6pc	30/17.0/18.0/1.4'		515g
			E6xE8; E7xE11; E10xE12; E14xE18; E16xE22; E20xE24		

12pc Midget combination wrench set



51214P		12pc	20/20.5/21.5/1.3'		1025g
			8; 9; 10; 11; 12; 13; 14; 15; 16; 17; 18; 19 mm		

6pc 75° Offset star wrench set



5065		6pc	20/15.2/16.2/1.4'		760g
			E6xE8; E7xE11; E10xE12; E14xE18; E16xE22; E20xE24		

8pc 45° Offset ring wrench set



5088-8 10/12.5/13.5/0.85' 1250g

	8pc	6x7; 8x9; 10x11; 12x13; 14x15; 16x17; 18x19; 20x22 mm
---	-----	--

8pc 45° Offset ring wrench set



5085 6/12.9/13.9/0.9' 2150g

	8pc	8x9; 10x11; 12x13; 14x15; 16x17; 18x19; 21x23; 22x24 mm
---	-----	--

12pc 45° Offset ring wrench set



51213P-8 6/20.4/21.4/1.4' 3400g

	12pc	6x7; 8x9; 10x11; 12x13; 14x15; 16x17; 18x19; 20x22; 21x23; 24x27; 25x28; 30x32 mm
---	------	--

6pc 45° Offset ring wrench set (SAE)



5069DS 10/12.2/13.2/0.7' 1220g

	6pc	1/4"x5/16"; 3/8"x7/16"; 1/2"x9/16"; 5/8"x11/16"; 3/4"x7/8"; 15/16"x1"
---	-----	--

8pc 45° Offset ring wrench set (SAE)



5085S 6/12.9/13.9/0.9' 2150g

	8pc	1/4"x5/16"; 3/8"x7/16"; 7/16"x1/2"; 1/2"x9/16"; 5/8"x11/16"; 11/16"x3/4"; 13/16"x7/8"; 7/8"x15/16"
---	-----	--

12pc 45° Offset ring wrench set (SAE)



51213SC-8 6/21.0/22.0/1.4' 3500g

	12pc	1/4"x5/16"; 5/16"x3/8"; 3/8"x7/16"; 1/2"x9/16"; 9/16"x5/8"; 5/8"x11/16"; 5/8"x3/4"; 3/4"x7/8"; 13/16"x7/8"; 15/16"x1"; 1"x1-1/16"; 1-1/8"x1-1/4"
---	------	--

6pc Midget 45° Offset ring wrench set



50624 30/19.0/20.0/1.6' 633g

	6pc	8x9; 10x11; 12x13; 14x15; 16x17; 18x19 mm
---	-----	---

4pc 75° Offset ring wrench set



T5044 6/13.7/14.7/0.73' 2280g

	4pc	23x26; 24x27; 25x28; 30x32 mm
---	-----	-------------------------------

6pc 75° Offset ring wrench set



50610		10/15.9/16.9/0.9'		1590g
	6pc	10x12; 12x14; 14x17; 17x19; 19x21; 23x26 mm		

7pc 75° Offset ring wrench set

NEW



50712		20/20.4/21.4/0.88'		1020g
	7pc	6x7; 8x9; 10x11; 12x13; 14x15; 16x17; 18x19 mm		

8pc 75° Offset ring wrench set

NEW



5088		10/14.5/15.5/0.9'		1450g
	8pc	6x7; 8x9; 10x11; 12x13; 14x15; 16x17; 18x19; 20x22 mm		

8pc 75° Offset ring wrench set



5081		6/11.8/12.8/0.9'		1966g
	8pc	6x7; 8x9; 10x11; 12x13; 14x15; 16x17; 18x19; 21x23 mm		

NEW 5081-24		6/11.8/12.8/0.9'		1966g
	8pc	6x7; 8x9; 10x11; 12x13; 14x15; 16x17; 18x19; 22x24 mm		

12pc 75° Offset ring wrench set



51213C		6/21.0/22.0/1.6'		3500g
	12pc	6x7; 8x9; 10x11; 12x13; 14x15; 16x17; 18x19; 20x22; 21x23; 24x27; 25x28; 30x32 mm		

6pc 75° Offset ring wrench set (SAE)

NEW



50610DS		10/13.3/14.3/0.7'		1330g
	6pc	1/4"x5/16"; 3/8"x7/16"; 1/2"x9/16"; 5/8"x11/16"; 3/4"x7/8"; 15/16"x1"		

8pc 75° Offset ring wrench set (SAE)



5081S		6/12.4/13.4/0.9'		2066g
	8pc	1/4"x5/16"; 3/8"x7/16"; 1/2"x9/16"; 5/8"x11/16"; 5/8"x3/4"; 3/4"x7/8"; 13/16"x7/8"; 15/16"x1"		

12pc 75° Offset ring wrench set (SAE)

NEW



51213SC		6/22.6/23.6/1.6'		3765g
	12pc	1/4"x5/16"; 5/16"x3/8"; 3/8"x7/16"; 1/2"x9/16"; 9/16"x5/8"; 5/8"x11/16"; 5/8"x3/4"; 3/4"x7/8"; 13/16"x7/8"; 15/16"x1"; 1"x1-1/8"; 1-1/16"x1-1/4"		

6pc Extra-long flat ring wrench set



50622		12/23.8/24.8/1.2'		1980g
	6pc	10x12; 12x14; 13x15; 14x17; 16x18; 17x19 mm		

6pc Extra-long flat ring wrench set



50622A		12/28.3/29.3/1.2'		2360g
	6pc	8x10; 12x14; 13x15; 16x18; 17x19; 22x24 mm		

8pc Flat ring wrench set



50821		10/8.0/9.0/0.69'		800g
	8pc	6x7; 8x9; 10x11; 12x13; 14x15; 16x17; 18x19; 20x22 mm		

12pc Flat ring wrench set



T51226		6/14.0/15.0/0.73'		2333g
	12pc	6x7; 8x9; 10x11; 12x13; 14x15; 16x17; 18x19; 20x22; 21x23; 22x24; 26x28; 30x32 mm		

8pc 15° Offset ring wrench set

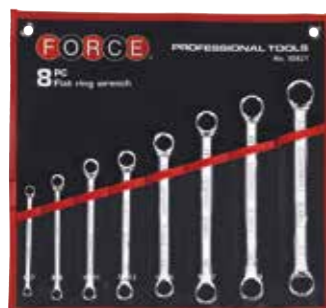

50821A		10/8.8/9.8/0.69'		880g
	8pc	6x7; 8x9; 10x11; 12x13; 14x15; 16x17; 18x19; 20x22 mm		

12pc 15° Offset ring wrench set



T51226A		6/14.1/15.1/0.73'		2350g
	12pc	6x7; 8x9; 10x11; 12x13; 14x15; 16x17; 18x19; 20x22; 21x23; 22x24; 26x28; 30x32 mm		

9pc Half-moon ring wrench set



50911		6/8.3/9.3/1.3'		1380g
	9pc	8x10; 10x12; 11x13; 12x14; 13x15; 14x17; 16x18; 17x19; 19x22 mm		

6pc S-form ring wrench set

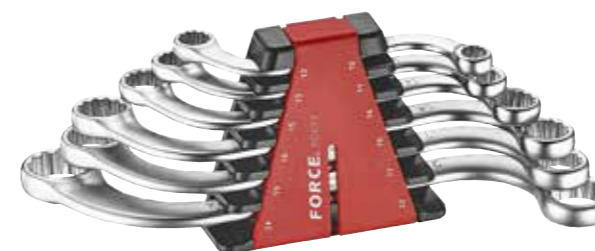

50634		10/11.0/12.0/1.1'		1100g
	6pc	10x12; 11x13; 14x15; 16x18; 17x19; 22x24 mm		



8pc Double ended 6pt.-6pt. socket wrench set





50817		6/7.2/8.2/0.9'		1200g
	7pc	6x7; 8x9; 10x11; 12x13; 14x15; 16x17; 18x19		
	1pc	220 mm		

14pc Double ended 6pt.-6pt. socket wrench set





5144  3/15.9/16.9/1.5'  5300g

	12pc	8x9; 10x11; 12x13; 14x15; 16x17; 18x19; 20x22; 21x23; 24x26; 25x28; 27x29; 30x32
	2pc	220; 300 mm

7pc Flat ratchet wrench set





50726  20/17.0/18.0/0.93'  842g

	7pc	8; 10; 12; 13; 14; 17; 19 mm
---	-----	------------------------------

12pc Flat ratchet wrench set







51210M  10/21.3/22.3/0.83'  2130g

	12pc	8; 9; 10; 11; 12; 13; 14; 15; 16; 17; 18; 19 mm
---	------	---

16pc Flat ratchet wrench & adapter set





5164  6/13.3/14.3/0.9'  2215g

	12pc	8; 9; 10; 11; 12; 13; 14; 15; 16; 17; 18; 19 mm
	3pc	10mmx1/4"DR.; 13mmx3/8"DR.; 19mmx1/2"DR.
	1pc	10mmx1/4" inhex

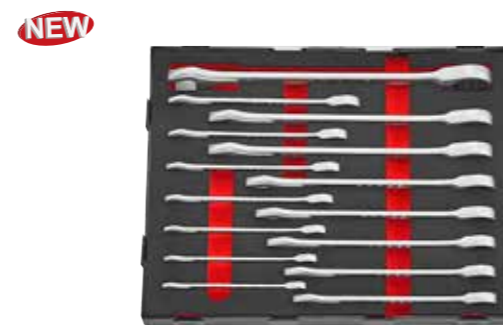
15pc Flat ratchet wrench set





K5156  6/19.2/20.2/1.5'  3196g

	15pc	8; 9; 10; 11; 12; 13; 14; 15; 16; 17; 18; 19; 21; 22; 24 mm
---	------	---

8pc Flat ratchet wrench set (SAE)







50812M  10/17.6/18.6/0.83'  1760g

	8pc	5/16"; 3/8"; 7/16"; 1/2"; 9/16"; 5/8"; 11/16"; 3/4"
---	-----	---

12pc Flat ratchet wrench & adapter set (SAE)





51215  6/8.0/9.0/0.9'  1320g

	8pc	5/16"; 3/8"; 7/16"; 1/2"; 9/16"; 5/8"; 11/16"; 3/4"
	3pc	3/8"x1/4"DR.; 1/2"x3/8"DR.; 3/4"x1/2"DR.
	1pc	3/8"x1/4" inhex

12pc Reversible ratchet wrench set







51211M  10/22.4/23.4/0.83'  2240g

	12pc	8; 9; 10; 11; 12; 13; 14; 15; 16; 17; 18; 19 mm
---	------	---

16pc Reversible ratchet wrench & adapter set





5164R  6/10.7/11.7/0.9'  1780g

	12pc	8; 9; 10; 11; 12; 13; 14; 15; 16; 17; 18; 19 mm
	3pc	10mmx1/4"DR.; 13mmx3/8"DR.; 19mmx1/2"DR.
	1pc	10mmx1/4"inhex

15pc Reversible ratchet wrench set





K5156R  6/20.3/21.3/1.5'  3388g

	15pc	8; 9; 10; 11; 12; 13; 14; 15; 16; 17; 18; 19; 21; 22; 24 mm
---	------	--

8pc Reversible ratchet wrench set (SAE)







50813M  10/18.0/19.0/0.83'  1800g

	8pc	5/16"; 3/8"; 7/16"; 1/2"; 9/16"; 5/8"; 11/16"; 3/4"
---	-----	---

12pc Reversible ratchet wrench & adapter set (SAE)





51215R  6/8.0/9.0/0.9'  1320g

	8pc	5/16"; 3/8"; 7/16"; 1/2"; 9/16"; 5/8"; 11/16"; 3/4"
	3pc	3/8"x1/4"DR.; 1/2"x3/8"DR.; 3/4"x1/2"DR.
	1pc	3/8"x1/4"inhex

7pc Flexible ratchet wrench set





50726F  20/20.5/21.5/0.93'  1024g

	7pc	8; 10; 12; 13; 14; 17; 19 mm
---	-----	------------------------------

12pc Flexible ratchet wrench set





K51210F  6/14.4/15.4/1.5'  2400g

	12pc	8; 9; 10; 11; 12; 13; 14; 15; 16; 17; 18; 19 mm
---	------	---

8pc Flexible ratchet wrench set (SAE)





K50812F  12/17.6/18.6/1.4'  1464g

	8pc	5/16"; 3/8"; 7/16"; 1/2"; 9/16"; 5/8"; 11/16"; 3/4"
---	-----	---

12pc Stubby flat ratchet wrench set





K51216  6/8.8/9.8/0.8'  1466g

	12pc	8; 9; 10; 11; 12; 13; 14; 15; 16; 17; 18; 19 mm
---	------	---

6pc Extra-long flat ratchet ring wrench set





50623  12/20.9/21.9/1.2'  1742g

	6pc	10x12; 12x14; 13x15; 14x17; 16x18; 17x19 mm
---	-----	---

6pc Flat ratchet ring wrench set





K50625  6/15.5/16.5/0.8'  2580g

	6pc	8x9; 10x11; 12x13; 14x15; 16x18; 17x19 mm
---	-----	---

4pc Flat ratchet star wrench set





K50411  12/15.0/16.0/1.1'  1250g



	4pc	E6xE8; E10xE12; E14xE18; E20xE24
---	-----	----------------------------------

13pc Flat ratchet wrench & flare nut wrench set

NEW





T51315  6/12.0/13.0/0.8'  2000g



	7pc	8; 10; 12; 13; 14; 17; 19 mm
	6pc	8x10; 9x11; 10x12; 11x13; 12x14; 17x19 mm

11pc Flat ratchet combination & star wrench set

NEW





T51115  6/9.0/10.0/0.66'  1500g

	7pc	8; 10; 12; 13; 14; 17; 19 mm
	4pc	E6xE8; E10xE12; E14xE18; E20xE24

8pc Flat ratchet ring wrench set





50810  6/12.0/13.0/0.9'  2000g

	8pc	6x7; 8x9; 10x11; 12x13; 14x15; 16x18; 17x19; 21x22 mm
---	-----	---

8pc 15° Offset ratchet ring wrench set





50811  6/11.5/12.5/0.9'  1917g

	8pc	6x7; 8x9; 10x11; 12x13; 14x15; 16x18; 17x19; 21x22 mm
---	-----	---

6pc 15° Offset ratchet star wrench set



50617  6/11.1/12.1/0.9'  1850g

	6pc	E6xE7; E8xE10; E11xE12; E14xE16; E18xE20; E22xE24
---	-----	---

Flare nut wrench



751		l		
Part no.	size	mm	g	pc/box
7510809 <small>NEW</small>	8x9	130	46	10
7510810	8x10	130	45	10
7510910 <small>NEW</small>	9x10	130	46	10
7510911	9x11	152	61	10
7511011	10x11	152	63	10
7511012	10x12	152	60	10
7511113	11x13	165	87	10
7511213	12x13	165	89	10
7511214	12x14	178	113	10
7511314	13x14	178	114	10
7511415	14x15	178	110	10
7511416	14x16	194	145	10
7511417	14x17	194	148	10
7511618	16x18	215	198	10
7511719	17x19	215	196	10
7511722	17x22	235	270	5
7511819	18x19	215	192	5
7511922	19x22	235	264	5
7512224	22x24	255	343	5
7512427	24x27	275	366	5
7512528	25x28	275	409	5
7513032	30x32	295	520	5
7513236	32x36	320	700	5
7513641	36x41	345	884	5
7510810S	5/16"x3/8"	130	46	10
7511011S	3/8"x7/16"	152	61	10
7511112S	7/16"x1/2"	165	89	10
7511214S	1/2"x9/16"	178	113	10
7511619S	5/8"x3/4"	215	195	10
7511719S	11/16"x3/4"	215	191	10
7511922S	3/4"x7/8"	235	267	5

Ratchet flare nut wrench



751... A		l		
Part no.	size	mm	g	pc/box
75108A	8	137	84	10
75110A	10	137	85	10
75111A	11	138	88	10
75112A	12	138	82	10
75113A	13	140	91	10
75114A	14	140	86	10
75117A	17	186	146	10
75119A	19	189	157	10
75122A	22	232	294	10

Crowfoot flare nut wrench



751		l		
Part no.	size	mm	g	pc/box
3/8"DR.				
751310	10	35	35	10
751311	11	35	33	10
751312	12	35	32	10
751313	13	35	30	10
751314	14	40	48	10
751315	15	40	46	10
751316	16	40	44	10
751317	17	44	69	10
751318	18	44	68	10
751319	19	44	64	10
751320	20	50	100	10
751321	21	50	97	10
751322	22	50	94	10

751		l		
Part no.	size	mm	g	pc/box
75133.8	3/8"	35	35	10
75137.16	7/16"	35	33	10
75131.2	1/2"	35	32	10
75139.16	9/16"	40	46	10
75135.8	5/8"	40	44	10
751311.16	11/16"	44	69	10
75133.4	3/4"	44	64	10
751313.16	13/16"	50	97	10
75137.8	7/8"	50	94	10
1/2"DR.				
751423	23	59	146	10
751424	24	59	145	10
751426	26	59	136	10
751415.16	15/16"	59	144	10
75141.0	1"	59	136	10

Hinged socket wrench



752		l		
Part no.	size	mm	g	pc/box
7520608 <small>NEW</small>	6x8	198	82	10
7520607	6x7	198	97	10
7520709 <small>NEW</small>	7x9	198	100	10
7520809	8x9	198	99	10
7520810	8x10	203	103	10
7521011	10x11	215	125	10
7521012	10x12	219	128	10
7521112 <small>NEW</small>	11x12	219	121	10
7521213	12x13	227	161	10
7521214	12x14	230	173	10
7521314 <small>NEW</small>	13x14	230	161	10
7521315 <small>NEW</small>	13x15	240	185	5
7521317	13x17	240	228	5
7521415	14x15	244	234	5
7521417	14x17	246	242	5

752		l		
Part no.	size	mm	g	pc/box
7521617	16x17	255	313	5
7521618	16x18	260	333	5
7521718 <small>NEW</small>	17x18	271	342	5
7521719 <small>NEW</small>	17x19	271	374	5
7521819	18x19	274	382	5
7521922	19x22	290	491	5
7522022	20x22	295	520	5
7522123	21x23	295	545	5
7522427	24x27	323	756	5
7523032	30x32	356	1083	5
7521011S	3/8"x7/16"	215	125	10
7521314S	1/2"x9/16"	232	173	10
7521617S	5/8"x11/16"	255	313	5
7521619S	5/8"x3/4"	271	322	5
7521719S	11/16"x3/4"	271	365	5
7521922S	3/4"x7/8"	290	491	5
7522122S	13/16"x7/8"	295	520	5
7522425S	15/16"x1"	323	756	5

Hinged star socket wrench



756...F		l		
Part no.	size	mm	g	pc/box
7560405F	E4xE5	198	83	10
7560607F	E6xE7	198	86	10
7560810F	E8xE10	198	88	10
7561112F	E11xE12	213	116	10
7561416F	E14xE16	227	175	10
7561820F	E18xE20	243	242	5
7562224F	E22xE24	277	424	5

Angle socket wrench, 6pt.-6pt.



753		<i>l</i>	<i>l</i>		
Part no.	size	short	long	g	pc/box
75305	5	26	102	30	10
753055	5.5	26	94	30	10
75306	6	26	94	30	10
75307	7	28	98	52	10
75308	8	32	114	66	10
75309	9	34	122	77	10
75310	10	37	129	96	10
75311	11	40	140	127	10
75312	12	43	147	163	10
75313	13	45	157	193	10
75314	14	47	164	217	10
75315	15	49	172	246	10
75316	16	53	186	315	5
75317	17	55	194	333	5
75318	18	58	197	348	5
75319	19	63	209	455	5
75320	20	63	207	458	5
75321	21	66	229	494	5
75322	22	69	231	559	5
75323	23	78	253	733	5
75324	24	79	255	777	5
75325	25	84	270	930	5
75326	26	85	278	962	5
75327	27	87	287	1132	5
75328	28	88	297	1202	5
75329	29	90	311	1274	5
75330	30	93	321	1464	5
75332	32	95	348	1600	5

Angle socket wrench, 12pt.-6pt.



753...A		<i>l</i>	<i>l</i>		
Part no.	size	short	long	g	pc/box
75306A	6	26	94	30	10
75307A	7	26	98	52	10
75308A	8	32	114	66	10
75309A	9	34	122	77	10
75310A	10	37	129	96	10
75311A	11	40	140	127	10
75312A	12	43	147	152	10
75313A	13	45	157	190	10
75314A	14	47	164	217	10
75315A	15	49	172	246	10
75316A	16	53	186	315	5
75317A	17	55	194	329	5
75318A	18	58	197	342	5
75319A	19	63	209	447	5
75320A	20	63	207	458	5
75321A	21	66	229	482	5
75322A	22	69	231	557	5
75323A	23	78	253	730	5
75324A	24	79	255	752	5
75326A	26	85	278	962	5
75327A	27	87	287	1102	5
75328A	28	88	297	1192	5
75330A	30	93	321	1464	5
75332A	32	95	348	1600	5

Rod-typed angle socket wrench



753...R		<i>l</i>	<i>l</i>		
Part no.	size	short	long	g	pc/box
75308R	8	110	260	216	10
75309R	9	110	265	360	10
75310R	10	110	265	361	10
75311R	11	110	265	366	10
75312R	12	110	265	379	10
75313R	13	110	265	380	10
75314R	14	110	265	384	10
75315R	15	110	265	497	10
75316R	16	110	265	527	5
75317R	17	110	265	596	5
75318R	18	110	265	613	5
75319R	19	110	265	621	5

Double open end wrench



754	<i>l</i>			
Part no.	size	mm	g	pc/box
7540506	5x6	123	27	10
7540507	5x7	123	27	10
7545507	5.5x7	123	27	10
7540608	6x8	123	27	10
7540607	6x7	123	27	10
7540708	7x8	123	27	10
7540809	8x9	141	42	10
7540810	8x10	141	40	10
7540911	9x11	157	54	10
7541011	10x11	157	63	10
7541012	10x12	157	63	10
7541013	10x13	172	85	10
7541113	11x13	172	85	10
7541112	11x12	172	85	10
7541213	12x13	172	83	10
7541214	12x14	180	92	10
7541314	13x14	180	92	10
7541315 <small>NEW</small>	13x15	180	92	10
7541317	13x17	195	99	10
7541415	14x15	190	106	10
7541417	14x17	195	113	10
7541516	15x16	190	115	10
7541617	16x17	205	142	10
7541618	16x18	205	134	10
7541719	17x19	220	174	5
7541721	17x21	220	174	5
7541819	18x19	220	175	5
7541921	19x21	236	200	5
7541922	19x22	236	200	5
7541924	19x24	246	253	5
7542022	20x22	236	223	5
7542123	21x23	246	260	5
7542126	21x26	255	266	5
7542224	22x24	246	253	5
7542326	23x26	265	279	5
7542426	24x26	265	266	5
7542427	24x27	265	318	5

754	<i>l</i>			
Part no.	size	mm	g	pc/box
7542430	24x30	286	410	5
7542528	25x28	279	322	5
7542629	26x29	286	410	5
7542632	26x32	290	460	5
7542729	27x29	286	410	5
7542730	27x30	286	410	5
7542732	27x32	290	460	5
7543032	30x32	297	465	5
7543034	30x34	350	608	5
7543236	32x36	350	635	5
7543436	34x36	350	730	5
7543641	36x41	380	950	5
7543842	38x42	380	915	5
7544146	41x46	415	1490	5
7544650	46x50	465	2084	5
7540608S	1/4"x5/16"	123	27	10
7540810S	5/16"x3/8"	141	40	10
7541011S	3/8"x7/16"	157	63	10
7541113S	7/16"x1/2"	172	85	10
7541314S	1/2"x9/16"	180	92	10
7541416S	9/16"x5/8"	190	107	10
7541617S	5/8"x11/16"	205	141	10
7541719S	11/16"x3/4"	220	191	5
7541720S	11/16"x25/32"	220	191	5
7541920S	3/4"x25/32"	236	191	5
7541921S <small>NEW</small>	3/4"x13/16"	236	196	5
7541922S <small>NEW</small>	3/4"x7/8"	236	195	5
7542122S	13/16"x7/8"	236	191	5
7542224S <small>NEW</small>	7/8"x15/16"	246	232	5
7542425S	15/16"x1"	265	308	5
7542427S	15/16"x1-1/16"	265	325	5
7542529S	1"x1-1/8"	279	312	5
7542732S	1-1/16"x1-1/4"	290	460	5
7542932S	1-1/8"x1-1/4"	297	478	5

Combination wrench



755	●	l	⚖	📦
Part no.	size	mm	g	pc/box
75503	3	83	13	20
75504	4	96	13	20
755045	4.5	96	13	20
75505	5	96	13	20
755055	5.5	100	16	10
75506	6	100	16	10
75507	7	110	21	10
75508	8	120	26	10
75509	9	130	33	10
75510	10	140	38	10
75511	11	150	48	10
75512	12	160	56	10
75513	13	170	73	10
75514	14	180	85	10
75515	15	190	99	10
75516	16	200	117	10
75517	17	210	136	10
75518	18	220	158	10
75519	19	230	175	5
75520	20	240	216	5
75521	21	250	227	5
75522	22	260	258	5
75523	23	270	285	5
75524	24	280	309	5
75525	25	290	330	5
75526	26	300	377	5
75527	27	310	403	5
75528	28	320	448	5
75529	29	330	499	5
75530	30	340	536	5
75531 <small>NEW</small>	31	360	663	5
75532	32	360	637	5
75533	33	385	616	5
75534	34	385	603	5
75535	35	410	850	5
75536	36	410	840	5
75537 <small>NEW</small>	37	435	1034	5
75538	38	435	998	5
75539 <small>NEW</small>	39	435	1002	5
75540 <small>NEW</small>	40	460	1304	5
75541	41	460	1281	5
75542	42	460	1258	5
75543	43	460	1237	5
75544 <small>NEW</small>	44	500	1712	5
75545 <small>NEW</small>	45	500	1730	5
75546	46	500	1679	5
75548	48	540	2170	5
75550	50	540	2130	5
75552 <small>NEW</small>	52	560	3075	5
75555	55	560	3054	4
75556	56	560	2985	4
75558	58	600	3994	2
75560	60	600	3850	2

755	●	l	⚖	📦
Part no.	size	mm	g	pc/box
75565	65	680	5826	4
75570	70	680	5625	4
75575	75	730	6900	2
75580	80	730	6400	2
75585	85	780	9500	2
75590	90	780	8900	2
75595	95	780	8700	2
755100	100	855	11150	2
755105	105	855	10500	2
7555.32 <small>NEW</small>	5/32"	96	13	20
7553.16 <small>NEW</small>	3/16"	96	13	20
7557.32 <small>NEW</small>	7/32"	100	18	10
7551.4	1/4"	100	17	10
7559.32 <small>NEW</small>	9/32"	110	22	10
7555.16	5/16"	120	28	10
75511.32 <small>NEW</small>	11/32"	130	33	10
7553.8	3/8"	140	43	10
75513.32 <small>NEW</small>	13/32"	140	39	10
7557.16	7/16"	150	49	10
75515.32 <small>NEW</small>	15/32"	160	59	10
7551.2	1/2"	170	75	10
7559.16	9/16"	180	89	10
7555.8	5/8"	200	120	10
75511.16	11/16"	210	136	10
7553.4	3/4"	230	181	5
75513.16	13/16"	250	245	5
7557.8	7/8"	260	256	5
75515.16	15/16"	280	312	5
7551.0	1"	300	383	5
7551.1.16	1-1/16"	310	429	5
7551.1.8	1-1/8"	330	504	5
7551.3.16 <small>NEW</small>	1-3/16"	340	485	5
7551.1.4	1-1/4"	360	656	5
7551.5.16	1-5/16"	385	615	5
7551.3.8	1-3/8"	410	859	5
7551.7.16	1-7/16"	435	1010	5
7551.1.2	1-1/2"	435	996	5
7551.9.16 <small>NEW</small>	1-9/16"	460	1320	5
7551.5.8	1-5/8"	460	1282	5
7551.11.16	1-11/16"	460	1249	5
7551.3.4	1-3/4"	500	1784	5
7551.13.16	1-13/16"	500	1685	5
7551.7.8	1-7/8"	540	2165	5
7552.0	2"	540	2130	5
7552.1.16	2-1/16"	560	2600	5
7552.1.8	2-1/8"	560	2900	5
7552.1.4	2-1/4"	600	3900	5
7552.5.16 <small>NEW</small>	2-5/16"	600	3880	5
7552.3.8	2-3/8"	600	3850	5
7552.7.16	2-7/16"	600	4640	5
7552.1.2	2-1/2"	680	5430	4
7552.5.8	2-5/8"	680	5571	4

75° Offset combination wrench



755...A	●	l	⚖	📦
Part no.	size	mm	g	pc/box
75506A	6	130	22	10
75507A	7	130	25	10
75508A	8	140	30	10
75509A	9	150	40	10
75510A	10	160	50	10
75511A	11	170	60	10
75512A	12	180	70	10
75513A	13	190	85	10
75514A	14	200	95	10
75515A	15	210	105	10
75516A	16	220	120	10
75517A	17	230	140	10
75518A	18	240	160	10
75519A	19	250	170	5
75520A	20	270	190	5
75521A	21	270	210	5
75522A	22	280	220	5
75523A	23	300	240	5
75524A	24	312	300	5
75525A	25	320	310	5
75526A	26	330	328	5
75527A	27	340	360	5
75528A	28	352	395	5
75529A <small>NEW</small>	29	363	520	5
75530A	30	373	475	5
75532A	32	395	545	5
75536A	36	410	775	5
75541A	41	460	1425	5
75546A	46	500	1675	5
75550A	50	540	2080	5
7551.4A	1/4"	130	22	10
7555.16A	5/16"	140	30	10
7553.8A	3/8"	160	50	10
7557.16A	7/16"	170	60	10
7551.2A	1/2"	190	70	10
7559.16A	9/16"	200	95	10
7555.8A	5/8"	220	120	10
75511.16A	11/16"	230	140	10
7553.4A	3/4"	250	170	5
75513.16A	13/16"	270	190	5
7557.8A	7/8"	280	220	5
75515.16A	15/16"	312	300	5
7551.0A	1"	330	310	5
7551.1.16A	1-1/16"	340	360	5
7551.1.8A	1-1/8"	373	395	5
7551.1.4A	1-1/4"	395	545	5

Long combination wrench



755...L	●	l	⚖	📦
Part no.	size	mm	g	pc/box
75506L	6	128	20	10
75507L	7	138	24	10
75508L	8	148	32	10
75509L	9	160	35	10
75510L	10	167	40	10
75511L	11	186	60	10
75512L	12	196	80	10
75513L	13	205	100	10
75514L	14	223	120	10
75515L	15	233	140	10
75516L	16	243	160	10
75517L	17	262	200	10
75518L	18	272	220	10
75519L	19	281	240	5
75520L	20	301	280	5
75521L	21	301	300	5
75522L	22	319	320	5
75523L	23	329	340	5
75524L	24	339	470	5
75525L	25	358	488	5
75526L	26	358	525	5
75527L	27	388	700	5
75528L	28	388	717	5
75529L	29	404	767	5
75530L	30	404	820	5
75531L	31	431	1100	5
75532L	32	431	1100	5
75533L	33	471	1100	5
75534L	34	471	1200	5
75535L	35	510	1250	5
75536L	36	510	1300	5

Spline combination wrench



755...Q						<i>l</i>			
Part no.	size	6point	12point	SAE	E-Torx	XZN	mm	g	pc/box
75506Q	M6	M6	M6		E8	6	105	17	10
75507Q	M7	M7	M7	9/32"		7	115	20	10
75508Q	M8	M8	M8	5/16"	E10	8	125	25	10
75509Q	M9	M9	M9	11/32"	E11	9	135	32	10
75510Q	M10	M10	M10	3/8"	E12	10	145	40	10
75511Q	M11	M11	M11	7/16"	E14	11	155	48	10
75512Q	M12	M12	M12	15/32"		12	165	58	10
75513Q	M13	M13	M13	1/2"	E16		175	68	10
75514Q	M14	M14	M14	9/16"	E18	14	185	84	10
75515Q	M15	M15	M15	19/32"			195	90	10
75516Q	M16	M16	M16	5/8"	E20	16	205	102	10
75517Q	M17	M17	M17				215	122	10
75518Q	M18	M18	M18		E22	18	225	128	10
75519Q	M19	M19	M19	3/4"	E24		235	154	5
75520Q	M20	M20	M20	25/32"		20	245	176	5
75521Q	M21	M21	M21	13/16"			255	208	5
75522Q	M22	M22	M22	7/8"		22	265	234	5
75523Q	M23	M23	M23				275	226	5
75524Q	M24	M24	M24	15/16"		24	285	286	5

Midget combination wrench



755S		<i>l</i>		
Part no.	size	mm	g	pc/box
755S08	8	91	25	10
755S09	9	97	32	10
755S10	10	97	32	10
755S11	11	100	45	10
755S12	12	105	47	10
755S13	13	108	55	10
755S14	14	115	67	10
755S15	15	118	76	10
755S16	16	122	88	10
755S17	17	130	108	10
755S18	18	133	115	10
755S19	19	138	134	10

Star wrench



756		<i>l</i>		
Part no.	size	mm	g	pc/box
7560607	E6xE7	112	21	10
7560608	E6xE8	112	21	10
7560711	E7xE11	125	34	10
7560810 <small>NEW</small>	E8xE10	125	32	10
7561012	E10xE12	140	42	10
7561418	E14xE18	180	82	10
7561622	E16xE22	200	129	10
7562024	E20xE24	224	173	10

75° Offset star wrench



756...A		<i>l</i>		
Part no.	size	mm	g	pc/box
7560608A	E6xE8	145	34	10
7560711A	E7xE11	155	42	10
7561012A	E10xE12	175	51	10
7561418A	E14xE18	215	112	10
7561622A	E16xE22	235	192	5
7562024A	E20xE24	265	224	5

45° Offset ring wrench



758		<i>l</i>		
Part no.	size	mm	g	pc/box
7580507	5x7	170	50	10
7580607	6x7	170	50	10
7580608	6x8	170	55	10
7580709	7x9	180	55	10
7580809	8x9	180	60	10
7580810	8x10	190	63	10
7581011	10x11	195	88	10
7581012	10x12	195	90	10
7581013	10x13	210	95	10
7581113	11x13	210	101	10
7581213	12x13	210	102	10
7581214	12x14	220	99	10
7581317	13x17	240	240	10
7581415	14x15	235	138	10
7581417	14x17	240	177	10
7581516	15x16	245	180	5
7581617	16x17	245	184	5
7581618	16x18	255	191	5
7581619	16x19	255	200	5
7581719	17x19	255	200	5
7581721	17x21	275	270	5

758		<i>l</i>		
Part no.	size	mm	g	pc/box
7581819	18x19	255	205	5
7581921	19x21	275	211	5
7581922	19x22	275	211	5
7581924	19x24	295	320	5
7582022	20x22	295	283	5
7582122	21x22	295	283	5
7582123	21x23	295	283	5
7582224	22x24	325	355	5
7582126	21x26	365	360	5
7582127	21x27	365	360	5
7582326	23x26	365	470	5
7582426	24x26	365	470	5
7582427	24x27	365	503	5
7582430	24x30	375	360	5
7582528	25x28	375	360	5
7582732 <small>NEW</small>	27x32	380	610	5
7583032	30x32	380	747	5
7580608S	1/4"x5/16"	170	54	10
7580810S	5/16"x3/8"	190	63	10
7581011S	3/8"x7/16"	195	88	10
7581113S	7/16"x1/2"	210	101	10
7581314S	1/2"x9/16"	220	102	10
7581416S	9/16"x5/8"	230	177	10
7581617S	5/8"x11/16"	245	180	5
7581619S	5/8"x3/4"	255	200	5
7581719S	11/16"x3/4"	255	208	5
7581921S	3/4"x13/16"	275	246	5
7581922S	3/4"x7/8"	275	210	5
7582122S	13/16"x7/8"	295	283	5
7582224S	7/8"x15/16"	325	355	5
7582425S	15/16"x1"	365	355	5
7582527S	1"x1-1/16"	375	355	5
7582932S	1-1/8"x1-1/4"	380	610	5

Midget 45° offset ring wrench



758S				
Part no.	size	mm	g	pc/box
758S0708	7x8	115	46	10
758S0809	8x9	115	46	10
758S0810	8x10	115	46	10
758S1011	10x11	115	46	10
758S1012	10x12	115	46	10
758S1213	12x13	140	86	10
758S1214	12x14	140	86	10
758S1314	13x14	140	86	10
758S1415	14x15	140	86	10
758S1417	14x17	157	134	10
758S1617	16x17	157	134	10
758S1618	16x18	157	134	10
758S1619	16x19	157	134	10
758S1719	17x19	157	134	10
758S1819	18x19	157	134	10
758S1011S	3/8"x7/16"	115	46	10
758S1314S	1/2"x9/16"	140	86	10
758S1619S	5/8"x3/4"	157	134	10

75° Offset ring wrench



759				
Part no.	size	mm	g	pc/box
7590607	6x7	175	53	10
7590608	6x8	175	46	10
7590709	7x9	190	50	10
7590809	8x9	190	64	10
7590810	8x10	190	64	10
7591011	10x11	205	100	10
7591012	10x12	205	101	10
7591113 ^{NEW}	11x13	217	132	10
7591213	12x13	220	132	10
7591214	12x14	220	135	10
7591314	13x14	220	135	10
7591315	13x15	245	150	10
7591317	13x17	265	200	10

759				
Part no.	size	mm	g	pc/box
7591415	14x15	245	161	10
7591417	14x17	265	207	10
7591516 ^{NEW}	15x16	270	198	10
7591617	16x17	270	206	10
7591618	16x18	270	203	10
7591719	17x19	300	257	5
7591819	18x19	300	258	5
7591921	19x21	325	311	5
7591922	19x22	325	319	5
7592022	20x22	325	319	5
7592122	21x22	325	319	5
7592123	21x23	335	388	5
7592224	22x24	335	358	5
7592326	23x26	345	489	5
7592426	24x26	345	492	5
7592427	24x27	345	496	5
7592526	25x26	345	496	5
7592528	25x28	355	536	5
7592627	26x27	355	522	5
7592628	26x28	355	534	5
7592730	27x30	370	573	5
7592732	27x32	370	612	5
7593032	30x32	370	664	5
7593236	32x36	402	905	5
7593436	34x36	440	908	5
7593641	36x41	440	1141	5
7593842 ^{NEW}	38x42	440	1192	5
7594146	41x46	470	1500	5
7594650	46x50	510	1650	5

7590608S	1/4"x5/16"	175	47	10
7590810S	5/16"x3/8"	190	100	10
7591011S	3/8"x7/16"	205	91	10
7591113S ^{NEW}	7/16"x1/2"	220	132	10
7591314S	1/2"x9/16"	220	131	10
7591416S	9/16"x5/8"	245	207	10
7591617S	5/8"x11/16"	270	188	10
7591619S	5/8"x3/4"	300	193	10
7591719S	11/16"x3/4"	300	257	10
7591922S	3/4"x7/8"	325	309	5
7592122S	13/16"x7/8"	325	310	5
7592224S	7/8"x15/16"	335	372	5
7592425S	15/16"x1"	345	496	5
7592427S	15/16"x1-1/16"	345	496	5
7592529S	1"x1-1/8"	355	458	5
7592729S	1-1/16"x1-1/8"	355	540	5
7592732S	1-1/16"x1-1/4"	370	651	5
7592932S	1-1/8"x1-1/4"	370	616	5

Extra-long flat ring wrench



760				
Part no.	size	mm	g	pc/box
7600810	8x10	240	87	10
7601011 ^{NEW}	10x11	290	148	10
7601012	10x12	290	124	10
7601214	12x14	330	200	10
7601315	13x15	360	333	10
7601417	14x17	360	333	10
7601618	16x18	405	458	10
7601719	17x19	405	447	10
7601819 ^{NEW}	18x19	405	480	10
7602123	21x23	435	660	10
7602224	22x24	435	602	10

Flat ring wrench



760M				
Part no.	size	mm	g	pc/box
760M0607	6x7	120	23	10
760M0809	8x9	135	31	10
760M1011	10x11	155	48	10
760M1213	12x13	165	64	10
760M1415	14x15	180	92	10
760M1617	16x17	210	118	10
760M1819	18x19	225	146	10
760M2022	20x22	240	186	10
760M2123	21x23	255	245	5
760M2224	22x24	255	224	5
760M2628	26x28	315	417	5
760M2729	27x29	315	414	5
760M3032	30x32	335	510	5

15° Offset ring wrench



760...A				
Part no.	size	mm	g	pc/box
7600607A	6x7	120	22	10
7600809A	8x9	135	32	10
7600911A ^{NEW}	9x11	155	55	10
7601011A	10x11	155	47	10
7601213A	12x13	165	64	10
7601415A	14x15	180	91	10
7601617A	16x17	210	118	10
7601819A	18x19	225	144	10
7602022A	20x22	240	190	10
7602123A	21x23	255	239	5
7602224A	22x24	255	234	5
7602628A	26x28	315	435	5
7602729A	27x29	315	419	5
7603032A	30x32	335	517	5

Half-moon ring wrench



761				
Part no.	size	mm	g	pc/box
7610810	8x10	138	56	10
7611012	10x12	141	65	10
7611113	11x13	165	104	10
7611214	12x14	165	93	10
7611315	13x15	190	134	10
7611417	14x17	190	141	10
7611618	16x18	220	190	10
7611719	17x19	220	190	10
7611922	19x22	255	240	5
7612224	22x24	285	410	5

S-form ring wrench



761...A		l		
Part no.	size	mm	g	pc/box
7611012A	10x12	142	56	10
7611113A	11x13	155	56	10
7611415A	14x15	188	100	10
7611618A	16x18	225	164	10
7611719A	17x19	237	198	5
7612224A	22x24	270	296	5
7611113AS	7/16"x1/2"	155	56	10
7611415AS	9/16"x5/8"	188	100	10
7611719AS	11/16"x3/4"	237	198	5
7612224AS	7/8"x15/16"	270	296	5

Double ended 6pt.-6pt. socket wrench



762		l		
Part no.	size	mm	g	pc/box
7620607	6x7	127	50	10
7620809	8x9	132	55	10
7620810	8x10	132	52	10
7621011	10x11	132	81	10
7621213	12x13	144	90	10
7621214	12x14	148	122	10
7621415	14x15	153	124	10
7621617	16x17	162	167	10
7621819	18x19	175	198	10
7622022	20x22	185	280	5
7622123	21x23	185	281	5
7622426	24x26	193	485	5
7622427	24x27	195	441	5
7622528	25x28	196	450	5
7622729	27x29	200	595	5
7623032	30x32	202	620	5

Bar for double ended socket wrench



762	l		
Part no.	mm	g	pc/box
762220	220	105	10
762300	300	250	10

- 762220 only for 7620607 - 7622123 use
- 762300 only for 7622426 - 7623032 use

Flat ratchet wrench



757		l		
Part no.	size	mm	g	pc/box
75708	8	140	36	10
75709	9	150	46	10
75710	10	160	59	10
75711	11	165	69	10
75712	12	170	83	10
75713	13	180	99	10
75714	14	190	122	10
75715	15	200	132	10
75716	16	210	154	10
75717	17	223	181	10
75718	18	233	204	10
75719	19	244	241	10
75720	20	275	330	5
75721	21	275	330	5
75722	22	290	355	5
75723	23	290	355	5
75724	24	290	355	5
7575.16	5/16"	140	36	10
7573.8	3/8"	160	59	10
7577.16	7/16"	165	69	10
7571.2	1/2"	170	83	10
7579.16	9/16"	190	122	10
7575.8	5/8"	210	154	10
75711.16	11/16"	223	181	10
7573.4	3/4"	244	241	10
75713.16	13/16"	275	355	5
7577.8	7/8"	290	355	5
75715.16	15/16"	290	355	5

Reversible ratchet wrench



757...R		l		
Part no.	size	mm	g	pc/box
75708R	8	140	43	10
75709R	9	150	51	10
75710R	10	160	66	10
75711R	11	165	72	10
75712R	12	170	83	10
75713R	13	180	106	10
75714R	14	190	126	10
75715R	15	200	142	10
75716R	16	210	158	10
75717R	17	223	196	10
75718R	18	233	219	10
75719R	19	244	263	10
75720R	20	275	330	5
75721R	21	275	330	5
75722R	22	290	355	5
75723R	23	290	355	5
75724R	24	320	488	5
7575.16R	5/16"	140	43	10
7573.8R	3/8"	160	66	10
7577.16R	7/16"	165	72	10
7571.2R	1/2"	170	83	10
7579.16R	9/16"	190	126	10
7575.8R	5/8"	210	158	10
75711.16R	11/16"	223	196	10
7573.4R	3/4"	244	263	10
75713.16R	13/16"	275	330	5
7577.8R	7/8"	290	355	5
75715.16R	15/16"	290	355	5

Flexible ratchet wrench



757...F		l		
Part no.	size	mm	g	pc/box
75708F	8	130	50	10
75709F	9	155	73	10
75710F	10	155	73	10
75711F	11	173	99	10
75712F	12	173	99	10
75713F	13	185	116	10
75714F	14	191	133	10
75715F	15	215	198	10
75716F	16	215	198	10
75717F	17	230	223	10
75718F	18	248	276	10
75719F	19	248	276	10
75720F NEW	20	285	400	5
75721F NEW	21	285	377	5
75722F NEW	22	285	350	5
75723F NEW	23	285	435	5
75724F NEW	24	325	520	5
7575.16F	5/16"	135	47	10
7573.8F	3/8"	158	69	10
7577.16F	7/16"	175	100	10
7571.2F	1/2"	185	118	10
7579.16F	9/16"	195	129	10
7575.8F	5/8"	215	196	10
75711.16F	11/16"	228	216	10
7573.4F	3/4"	248	269	10
75713.16F	13/16"	280	458	5
7577.8F	7/8"	280	442	5
75715.16F	15/16"	310	545	5
7571.0F	1"	310	526	5

Stubby flat ratchet wrench



757S		<i>l</i>		
Part no.	size	mm	g	pc/box
757S08	8	92	29	10
757S09	9	92	43	10
757S10	10	94	43	10
757S11	11	105	59	10
757S12	12	105	59	10
757S13	13	105	65	10
757S14	14	115	89	10
757S15	15	120	117	10
757S16	16	120	117	10
757S17	17	125	122	10
757S18	18	138	167	10
757S19	19	138	167	10

Flat ratchet ring wrench



827M		<i>l</i>		
Part no.	size	mm	g	pc/box
827M0809	8x9	135	52	10
827M0810	8x10	135	60	10
827M1011	10x11	145	70	10
827M1213	12x13	165	92	10
827M1415	14x15	180	134	10
827M1618	16x18	205	175	10
827M1719	17x19	225	198	10

Ratchet wrench adapter



831		
Part no.	size	g
831210	10mm x 1/4"DR.	10
831313	13mm x 3/8"DR.	20
831419	19mm x 1/2"DR.	50
831H210	10mm x 1/4"ihex	9
83123.8	3/8" x 1/4"DR.	10
83131.2	1/2" x 3/8"DR.	20
83143.4	3/4" x 1/2"DR.	50
831H23.8	3/8" x 1/4"ihex	9

15° Offset ratchet ring wrench



825		<i>l</i>		
Part no.	size	mm	g	pc/box
8250607	6x7	110	68	5
8250809	8x9	130	83	5
8251011	10x11	140	94	5
8251213	12x13	175	167	5
8251415	14x15	175	165	5
8251618	16x18	205	272	5
8251719	17x19	205	164	5
8252122	21x22	300	303	5
8250607S	1/4"x5/16"	110	68	5
8251011S	3/8"x7/16"	140	94	5
8251213S	1/2"x9/16"	175	167	5
8251618S	5/8"x11/16"	205	272	5
8252122S	3/4"x7/8"	300	303	5

Extra-long flat ratchet ring wrench



827		<i>l</i>		
Part no.	size	mm	g	pc/box
8271012	10x12	295	130	10
8271214	12x14	330	178	10
8271315	13x15	370	265	10
8271417	14x17	370	265	10
8271618	16x18	405	357	10
8271719	17x19	405	367	10

Flat ratchet star wrench



828		<i>l</i>		
Part no.	size	mm	g	pc/box
8280608	E6xE8	129	56	10
8281012	E10xE12	144	75	10
8281418	E14xE18	180	147	10
8282024	E20xE24	225	208	10

Flat ratchet ring wrench



824		<i>l</i>		
Part no.	size	mm	g	pc/box
8240607	6x7	115	64	5
8240809	8x9	135	80	5
8241011	10x11	145	88	5
8241213	12x13	180	168	5
8241415	14x15	180	158	5
8241618	16x18	210	260	5
8241719	17x19	210	252	5
8242122	21x22	305	294	5
8240607S	1/4"x5/16"	115	64	5
8241011S	3/8"x7/16"	145	88	5
8241213S	1/2"x9/16"	180	168	5
8241618S	5/8"x11/16"	210	252	5
8242122S	3/4"x7/8"	305	294	5

15° Offset ratchet star wrench



826		<i>l</i>		
Part no.	size	mm	g	pc/box
8260607	E6xE7	110	64	5
8260810	E8xE10	130	88	5
8261112	E11xE12	140	100	5
8261416	E14xE16	175	183	5
8261820	E18xE20	205	260	5
8262224	E22xE24	300	294	5

Single open end wrench



791		<i>l</i>		
Part no.	size	mm	g	pc/box
79116	16	160	100	10
79117	17	160	100	10
79118	18	160	100	10
79119	19	175	120	10
79120	20	175	120	10
79121	21	175	120	10
79122	22	195	177	10
79123	23	195	177	10
79124	24	195	177	10
79125	25	215	266	10
79126	26	215	266	10
79127	27	215	266	10
79128	28	240	352	10
79129	29	240	352	10
79130	30	240	352	10
79132	32	270	467	10
79133	33	270	467	10
79134	34	270	467	10
79135	35	296	700	10
79136	36	296	700	10
79138	38	296	700	10
79141	41	335	1015	5
79142	42	335	1015	5
79143	43	335	1015	5
79144	44	370	1230	2
79145	45	370	1230	2
79146	46	370	1230	2
79148	48	410	1810	2
79150	50	410	1810	2
79152	52	410	1810	2
79155	55	488	2720	5
79156	56	488	2720	5
79158	58	488	2720	5
79160	60	488	2720	5

791		<i>l</i>		
Part no.	size	mm	g	pc/box
79165	65	488	1850	10
79170	70	595	2300	5
79175	75	595	2800	5
79180	80	595	3250	5
79185	85	500	3650	5
7915.8	5/8"	160	177	10
79111.16	11/16"	160	177	10
7913.4	3/4"	175	266	10
79113.16	13/16"	175	266	10
7917.8	7/8"	195	352	10
79115.16	15/16"	195	467	10
7911.0	1"	215	467	10
7911.1.16	1-1/16"	215	700	10
7911.1.8	1-1/8"	240	700	10
7911.1.4	1-1/4"	270	700	10
7911.5.16	1-5/16"	270	1000	10
7911.3.8	1-3/8"	296	1000	10
7911.7.16	1-7/16"	296	1000	10
7911.1.2	1-1/2"	296	1000	10
7911.5.8	1-5/8"	335	1026	5
7911.11.16	1-11/16"	335	1028	5
7911.3.4	1-3/4"	370	1210	2
7911.13.16	1-13/16"	370	1190	2
7911.7.8	1-7/8"	410	1782	2
7912.0	2"	410	1772	2

Single ring wrench



792		<i>l</i>		
Part no.	size	mm	g	pc/box
79217	17	330	340	5
79218	18	330	340	5
79219	19	330	340	5
79221	21	370	542	5
79222	22	370	542	5
79223	23	370	542	5
79224	24	387	678	5
79226	26	387	678	5
79227	27	395	762	5
79229	29	395	762	5
79230	30	416	870	5
79232	32	416	870	5
79233 <small>NEW</small>	33	470	1346	2
79234	34	470	1422	2
79235	35	470	1422	2
79236	36	470	1422	2
79238	38	493	1676	2
79240 <small>NEW</small>	40	493	1550	2
79241	41	493	1676	2
79242	42	493	1853	2
79243	43	525	2030	2
79244	44	525	2030	2
79246	46	525	2030	2
79248	48	600	3100	4
79250	50	600	3200	4
79252	52	600	3200	4
79255	55	600	3200	5
79256	56	600	3200	5
79258	58	625	4860	5
79260	60	625	4860	5
79265	65	625	4860	5

792		<i>l</i>		
Part no.	size	mm	g	pc/box
7925.8 <small>NEW</small>	5/8"	330	362	5
79211.16 <small>NEW</small>	11/16"	330	348	5
7923.4 <small>NEW</small>	3/4"	330	351	5
79213.16 <small>NEW</small>	13/16"	370	541	5
7927.8 <small>NEW</small>	7/8"	370	538	5
79215.16 <small>NEW</small>	15/16"	387	645	5
7921.0 <small>NEW</small>	1"	387	655	5
7921.1.16 <small>NEW</small>	1-1/16"	395	767	5
7921.1.8 <small>NEW</small>	1-1/8"	395	748	5
7921.1.4 <small>NEW</small>	1-1/4"	416	860	5
7921.5.16 <small>NEW</small>	1-5/16"	470	1357	2
7921.3.8 <small>NEW</small>	1-3/8"	470	1375	2
7921.7.16 <small>NEW</small>	1-7/16"	470	1336	2
7921.1.2 <small>NEW</small>	1-1/2"	493	1655	2
7921.5.8 <small>NEW</small>	1-5/8"	493	1622	2
7921.11.16 <small>NEW</small>	1-11/16"	525	2023	2
7921.3.4 <small>NEW</small>	1-3/4"	525	1952	2
7921.13.16 <small>NEW</small>	1-13/16"	525	1938	2
7921.7.8 <small>NEW</small>	1-7/8"	600	3371	4
7922.0 <small>NEW</small>	2"	600	3317	4

Slugging open end wrench

NEW



796		l		
Part no.	size	mm	g	pc/box
79624	24	177	300	5
79627	27	177	305	5
79630	30	190	413	5
79632	32	190	425	5
79636	36	215	627	5
79638	38	215	750	5
79641	41	235	900	5
79646	46	255	1050	5
79650	50	275	1500	2
79655	55	300	1500	2
79660	60	320	2500	5
79665	65	342	3375	5
79670	70	375	4375	4
79675	75	375	4700	4
79680	80	360	5500	3
79685	85	380	5200	3
79690	90	400	7000	2
79695	95	400	6750	2
79698	98	480	11800	1
796100	100	430	10500	1
796105	105	430	11100	1
796110	110	465	13200	1
796115	115	465	15200	1
796120	120	500	13000	1
796125	125	500	20600	1

Slugging ring wrench



793		l		
Part no.	size	mm	g	pc/box
79317 NEW	17	163	242	10
79318 NEW	18	163	237	10
79319 NEW	19	163	235	10
79321 NEW	21	163	264	10
79322	22	163	242	10
79323	23	163	242	10
79324	24	163	242	10
79325	25	163	242	10
79326	26	180	340	10
79327	27	180	340	10
79328	28	180	340	10
79329	29	190	416	10
79330	30	190	416	10
79332	32	190	416	10
79333	33	190	416	10
79334	34	205	518	5
79335	35	205	518	5
79336	36	205	518	5
79338	38	205	518	5
79340	40	230	735	5
79341	41	230	735	5
79342	42	230	735	5
79343	43	230	735	5
79344	44	240	930	5
79345	45	240	930	5
79346	46	240	930	5
79347	47	240	930	5
79348	48	255	1162	5
79350	50	255	1162	5
79352	52	255	1162	5
79354 NEW	54	270	1480	5
79355	55	270	1362	5
79356	56	270	1423	5
79360	60	280	1681	5
79363 NEW	63	280	1880	5
79365	65	280	2050	5
79370	70	335	3000	6
79375	75	335	3000	6
79378	78	365	5280	4
79380	80	365	4000	4
79382	82	365	5037	4
79385	85	365	4000	4
79390	90	400	5450	3
79395	95	400	5450	3
79398	98	435	6624	2

793		l		
Part no.	size	mm	g	pc/box
793100	100	435	9777	2
793105	105	435	9360	2
793110	110	450	8470	2
793115	115	450	8855	2
793120	120	480	11900	1
793125	125	480	11500	1
793130	130	510	14080	1
7933.4 NEW	3/4"	163	225	10
7937.8 NEW	7/8"	163	249	10
7931.0	1"	163	242	10
7931.1.16	1-1/16"	180	340	10
7931.1.8	1-1/8"	190	416	10
7931.3.16	1-3/16"	190	416	10
7931.1.4	1-1/4"	190	416	10
7931.5.16	1-5/16"	190	416	10
7931.3.8	1-3/8"	205	518	5
7931.7.16	1-7/16"	205	518	5
7931.1.2	1-1/2"	205	518	5
7931.5.8	1-5/8"	230	735	5
7931.11.16	1-11/16"	230	735	5
7931.3.4	1-3/4"	240	930	5
7931.13.16	1-13/16"	240	930	5
7931.7.8	1-7/8"	255	1162	5
7932.0	2"	255	1162	5
7932.1.8 NEW	2-1/8"	270	1477	5
7932.1.4 NEW	2-1/4"	280	2034	5
7932.5.16 NEW	2-5/16"	280	1790	5
7932.3.8 NEW	2-3/8"	280	1757	5
7932.7.16 NEW	2-7/16"	280	1922	5
7932.1.2 NEW	2-1/2"	280	1854	5
7932.9.16 NEW	2-9/16"	280	1620	5
7932.5.8 NEW	2-5/8"	280	1765	5
7932.3.4 NEW	2-3/4"	335	3276	6
7932.7.8 NEW	2-7/8"	335	3188	6
7933.0 NEW	3"	335	3170	6

Slugging ring wrench, deep offset



794		l		
Part no.	size	mm	g	pc/box
79424	24	250	1300	5
79427	27	250	1260	5
79430	30	270	1505	2
79432	32	270	1465	2
79436	36	300	1800	2
79438	38	300	1760	2
79441	41	320	2640	1
79443	43	320	2580	1
79446	46	360	3400	6
79450	50	360	3300	6
79455	55	360	3440	4
79460	60	360	3560	4
79465	65	380	5500	2
79470	70	380	7900	2
79475	75	420	7000	2
79480	80	420	7460	2
79485	85	450	8000	1
79490	90	450	10750	1
79495	95	500	13920	1
79498	98	500	13660	1
794100	100	500	13560	1
794105	105	515	14260	1
794110	110	515	13480	1
794115	115	515	13420	1
7941.1.4 NEW	1-1/4"	270	1460	2
7941.5.16 NEW	1-5/16"	270	1440	2
7941.3.8 NEW	1-3/8"	270	1430	2
7941.7.16 NEW	1-7/16"	300	1800	2
7941.1.2 NEW	1-1/2"	300	1790	2
7941.5.8 NEW	1-5/8"	320	2580	1
7941.11.16 NEW	1-11/16"	320	2580	1
7941.3.4 NEW	1-3/4"	320	2540	1
7941.13.16 NEW	1-13/16"	360	3370	6
7941.7.8 NEW	1-7/8"	360	3330	6
7942.0 NEW	2"	360	3260	6

Slugging ring wrench head, deep offset



795		<i>l</i>		
Part no.	size	mm	g	pc/box
79524	24	195	640	5
79527	27	195	600	5
79530	30	200	745	5
79532	32	200	705	5
79536	36	216	1040	5
79538	38	216	1020	2
79541	41	247	1360	2
79543	43	247	1320	2
79546	46	274	1860	2
79550	50	274	1800	2
79555	55	287	2120	2
79560	60	300	2340	4
79565	65	309	3500	6
79570	70	309	3340	6
79575	75	340	4500	4
79580	80	340	4760	4
79585	85	365	7220	2
79590	90	365	7040	2
79595	95	378	9080	2
795100	100	378	8720	2
795105	105	380	9340	2
795110	110	380	10040	2
795115	115	380	9480	2

Handle bar



795	<i>l</i>		
Part no.	mm	g	pc/ctn
795350	350	960	20
795580	580	1600	10
795850	850	2300	10

Assembly:

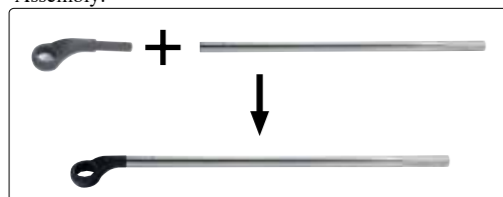

Ratchet double socket wrench



822		<i>l</i>		
Part no.	Socket	mm	g	pc/box
8221012	10x12	240	135	1
8221013	10x13	240	135	1
8221014	10x14	240	135	1
8221113	11x13	240	135	1
8221214	12x14	240	135	1
8221317	13x17	280	240	1
8221415	14x15	280	240	1
8221417	14x17	280	240	1
8221419	14x19	315	450	1
8221719	17x19	315	450	1
8221721	17x21	315	450	1
8221722	17x22	315	450	1
8221921	19x21	315	450	1
8221922	19x22	315	450	1
8221923	19x23	360	800	1
8221924	19x24	360	800	1
8222123	21x23	360	800	1
8222126	21x26	360	800	1
8222127	21x27	360	800	1
8222224	22x24	360	800	1
8222326	23x26	360	800	1
8222427	24x27	360	800	1
8222430	24x30	450	1200	1
8222629	26x29	450	1200	1
8222632	26x32	450	1200	1
8222730	27x30	450	1200	1
8222732	27x32	450	1200	1
8223032	30x32	450	1200	1
8223033	30x33	450	1200	1
8223036	30x36	450	1200	1
8223235	32x35	450	1200	1
8223236	32x36	450	1200	1
8223638	36x38	450	1200	1
8223641	36x41	450	1200	1
8223841	38x41	450	1200	1
8223646	36x46	500	2300	1
8223846	38x46	500	2300	1
8224146	41x46	500	2300	1
8223650	36x50	500	2300	1
8223850	38x50	500	2300	1
8224150	41x50	500	2300	1
8224650	46x50	500	2300	1
8224155	41x55	500	2300	1
8224655	46x55	500	2300	1
8225055	50x55	500	2300	1



7pc 1/4" Star tamperproof bit set



2071		200/12.0/13.0/1.3'	△ 60g
7pc		1/4" T-10H; T-15H; T-20H; T-25H; T-27H; T-30H; T-40H (25mmL)	

10pc 1/4" Double end phillips bit set

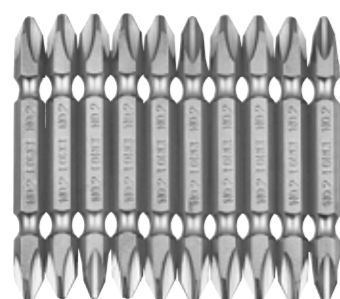

2101		100/11.6/12.6/0.8'	△ 116g
10pc		121452D 1/4" PH.2 (45mmL)	

2101L		100/11.6/12.6/0.8'	△ 116g
10pc		121652D 1/4" PH.2 (65mmL)	

10pc 1/4" Bit set



21010		100/10.0/11.0/1.5'	△ 100g
4pc		1/4" PH.0; PH.1; PH.2; PH.3 (25mmL)	
3pc		1/4" PZ.1; PZ.2; PZ.3 (25mmL)	
3pc		1/4" 4; 5.5; 6.5 mm (25mmL)	

10pc 1/4" Hex bit set



21011		100/12.1/13.1/1.5'	△ 121g
10pc		1/4" 2; 2.5; 3; 4; 5; 5.5; 6; 7; 8; 10 mm (25mmL)	

NEW 21011S		100/12.1/13.1/1.5'	△ 121g
10pc		1/4" 1/16"; 3/32"; 1/8"; 5/32"; 3/16"; 7/32"; 1/4"; 9/32"; 5/16"; 3/8" (25mmL)	

10pc 1/4" Star bit set



21012		100/10.0/11.0/1.5'	△ 100g
10pc		1/4" T7; T8; T9; T10; T15; T20; T25; T27; T30; T40 (25mmL)	

10pc 1/4" Star tamperproof bit set



21012T		100/10.0/11.0/1.5'	△ 100g
10pc		1/4" T-7H; T-8H; T-9H; T-10H; T-15H; T-20H; T-25H; T-27H; T-30H; T-40H (25mmL)	

10pc 1/4" Five-sided star tamperproof bit set

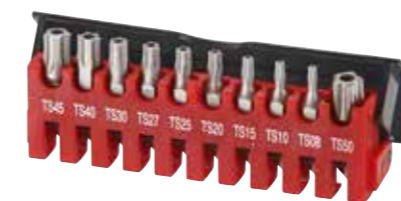

21013		100/10.0/11.0/1.5'	△ 100g
10pc		1/4" TS8; TS10; TS15; TS20; TS25; TS27; TS30; TS40; TS45; TS50 (25mmL)	

11pc 1/4" Bit set



21111		100/15.5/16.5/0.96'	△ 155g
4pc		1/4" PH.0; PH.1; PH.2; PH.3 (25mmL)	
4pc		1/4" PZ.0; PZ.1; PZ.2; PZ.3 (25mmL)	
2pc		1/4" 5.5; 6.5 mm (25mmL)	
1pc		Magnetic QR 1/4"Hex-1/4"Hex 2.3"(60mm)	

11pc 1/4" Bit set



21112		100/15.5/16.5/0.96'	△ 155g
4pc		1/4" PH.1; PH.2 x 2; PH.3 (25mmL)	
4pc		1/4" PZ.1; PZ.2 x 2; PZ.3 (25mmL)	
2pc		1/4" 5.5; 6.5 mm (25mmL)	
1pc		Magnetic QR 1/4"Hex-1/4"Hex 2.3"(60mm)	



11pc 1/4" Star bit set





21113		100/15.5/16.5/0.96'	△ 155g
10pc		1/4" T7; T8; T9; T10; T15; T20; T25; T27; T30; T40 (25mmL)	
1pc		Magnetic QR 1/4"Hex-1/4"Hex 2.3"(60mm)	

11pc 1/4" Star tamperproof bit set











21113T  100/15.5/16.5/0.96"  155g

	10pc	1/4" T-7H; T-8H; T-9H; T-10H; T-15H; T-20H; T-25H; T-27H; T-30H; T-40H (25mmL)
	1pc	Magnetic QR 1/4"Hex-1/4"Hex-1/4"Hex 2.3"(60mm)

31pc 1/4" Bit set











2311  40/12.6/13.6/1.1"  315g

	6pc	1/4" PH.0; PH.1 x 2; PH.2 x 2; PH.3 (25mmL)
	6pc	1/4" PZ.0; PZ.1 x 2; PZ.2 x 2; PZ.3 (25mmL)
	4pc	1/4" 3; 4; 5; 6.5 mm (25mmL)
	6pc	1/4" 2; 2.5; 3; 4; 5; 6 mm (25mmL)
	8pc	1/4" T-10H; T-15H; T-20H; T-25H; T-27H; T-30H; T-35H; T-40H (25mmL)
	1pc	Magnetic QR 1/4"Hex-1/4"Hex 2.3"(60mm)

31pc 1/4" Bit set





2313  48/14.4/15.4/1.2"  300g







	6pc	1/4" PH.0; PH.1 x 2; PH.2 x 2; PH.3 (25mmL)
	5pc	1/4" PZ.1 x 2; PZ.2 x 2; PZ.3 (25mmL)
	3pc	1/4" 4; 5.5; 6.5 mm (25mmL)
	4pc	1/4" 3; 4; 5; 6 mm (25mmL)
	12pc	1/4" T5; T6; T7; T8; T9; T10; T15; T20; T25; T27; T30; T40 (25mmL)
	1pc	Magnetic QR 1/4"Hex-1/4"Hex 2.3"(60mm)

31pc 1/4" Bit set

NEW











2313A  48/14.5/15.5/1.2"  302g

	4pc	1/4" PH.1; PH.2 x 2; PH.3 (25mmL)
	2pc	1/4" PZ.1; PZ.2 (25mmL)
	4pc	1/4" 3; 4; 5; 6 mm (25mmL)
	10pc	1/4" T5; T6; T8; T10; T15; T20; T25; T27; T30; T40 (25mmL)
	10pc	1/4" T-6H; T-8H; T-10H; T-15H; T-20H; T-25H; T-27H; T-30H; T-35H; T-40H (25mmL)
	1pc	Magnetic QR 1/4"Hex-1/4"Hex 3"(75mm)

31pc 1/4" Security bit set









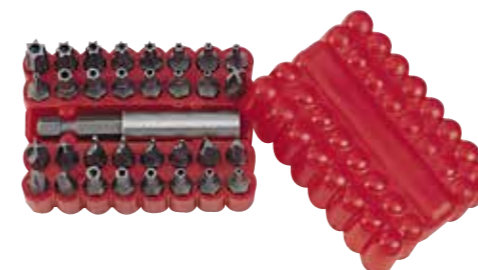

2315  48/14.4/15.4/1.2"  300g

	4pc	1/4" 6; 8; 10 mm (25mmL) 1/4" (25mmL)
	3pc	1/4" 1; 2; 3 (25mmL)
	4pc	1/4" 4; 6; 8; 10 mm (25mmL)
	4pc	1/4" No.0; No.1; No.2; No.3 (25mmL)
	6pc	1/4" 2; 2.5; 3; 4; 5; 6 mm (25mmL)
	9pc	1/4" T-7H; T-8H; T-10H; T-15H; T-20H; T-25H; T-27H; T-30H; T-40H (25mmL)
	1pc	Magnetic QR 1/4"Hex-1/4"Hex 2.3"(60mm)

33pc 1/4" Security bit set





2331  80/20.0/21.0/1.6"  250g







	3pc	1/4" 6; 8; 10 mm (25mmL)
	4pc	1/4" 1; 2; 3; 4 (25mmL)
	4pc	1/4" 4; 6; 8; 10 mm (25mmL)
	6pc	1/4" 2; 2.5; 3; 4; 5; 6 mm (25mmL)
	6pc	1/4" 5/32"; 9/64"; 1/8"; 7/64"; 3/32"; 5/64" (25mmL)
	9pc	1/4" T-8H; T-10H; T-15H; T-20H; T-25H; T-27H; T-30H; T-35H; T-40H (25mmL)
	1pc	Magnetic 1/4"Hex-1/4"Hex 2.3"(60mm)

33pc 1/4" Security bit set

NEW





2331A  80/20.0/21.0/1.6"  250g





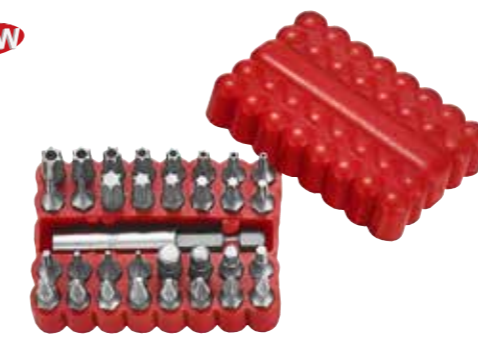

	6pc	1/4" 2; 4; 6; 8; 10 mm (25mmL) 1/4" (25mmL)
	4pc	1/4" 1; 2; 3; 4 (25mmL)
	6pc	1/4" 4; 6; 8; 10; 12; 14 mm (25mmL)
	4pc	1/4" No.0; No.1; No.2; No.3 (25mmL)
	6pc	1/4" 2; 2.5; 3; 4; 5; 6 mm (25mmL)
	6pc	1/4" 5/64"; 3/32"; 7/64"; 1/8"; 9/64"; 5/32" (25mmL)
	1pc	Magnetic 1/4"Hex-1/4"Hex 2.3"(60mm)

33pc 1/4" Bit set

NEW



2332  80/21.6/22.6/1.6"  270g

	5pc	1/4" PH.1 x 2; PH.2 x 2; PH.3 (25mmL)
	3pc	1/4" PZ.1; PZ.2 x 2 (25mmL)
	4pc	1/4" 3; 4; 5; 6 mm (25mmL)
	10pc	1/4" T5; T6; T8; T10; T15; T20; T25; T27; T30; T40 (25mmL)
	10pc	1/4" T-6H; T-8H; T-10H; T-15H; T-20H; T-25H; T-27H; T-30H; T-35H; T-40H (25mmL)
	1pc	Magnetic 1/4"Hex-1/4"Hex 2.3"(60mm)

61pc 1/4" Bit set



2611A 30/16.1/17.1/0.98' Δ 520g

	23pc	1/4" PH.1 x 7; PH.2 x 13; PH.3 x 3 (25mmL)
	23pc	1/4" PZ.1 x 7; PZ.2 x 13; PZ.3 x 3 (25mmL)
	3pc	1/4" 4; 5.5; 6.5 mm (25mmL)
	4pc	1/4" 3; 4; 5; 6 mm (25mmL)
	7pc	1/4" T10; T15; T20; T25; T27; T30; T40 (25mmL)
	1pc	Magnetic QR 1/4"Hex-1/4"Hex 2.3"(60mm)

2611B 30/16.1/17.1/0.98' Δ 520g

Changed items

	1pc	Magnetic QR 1/4"Hex-1/4"Hex 3"(75mm)
--	-----	--------------------------------------

61pc 1/4" Bit set

NEW



2613 30/15.7/16.7/0.98' Δ 524g

	7pc	1/4" PH.0; PH.1 x 2; PH.2 x 3; PH.3 (25mmL)
	4pc	1/4" PZ.1; PZ.2 x 2; PZ.3 (25mmL)
	5pc	1/4" 3; 4; 5; 5.5; 6.5 mm (25mmL)
	9pc	1/4" 2; 2.5; 3; 4; 5; 6; 7; 8; 10 mm (25mmL)
	13pc	1/4" T4; T5; T6; T7; T8; T9; T10; T15; T20; T25; T27; T30; T40 (25mmL)
	12pc	1/4" T-6H; T-7H; T-8H; T-9H; T-10H; T-15H; T-20H; T-25H; T-27H; T-30H; T-35H; T-40H (25mmL)
	10pc	1/4" TS8; TS10; TS15; TS20; TS25; TS27; TS30; TS40; TS45; TS50 (25mmL)
	1pc	Magnetic QR 1/4"Hex-1/4"Hex 3"(75mm)

102pc 1/4" Bit set



21021 10/9.7/10.7/1' Δ 970g

	40pc	Each 10pcs - 1/4" PH.0; PH.1; PH.2; PH.3 (25mmL)
	30pc	Each 10pcs - 1/4" PZ.1; PZ.2; PZ.3 (25mmL)
	30pc	Each 10pcs - 1/4" 4; 5.5; 6.5 mm (25mmL)
	1pc	Magnetic 1/4"Hex-1/4"Hex 2.3"(60mm)
	1pc	Magnetic QR 1/4"Hex-1/4"Hex 2.3"(60mm)

102pc 1/4" Bit set



21022 20/17.8/18.8/0.9' Δ 1550g

	15pc	Each 5pcs - 1/4" PH.1; PH.2; PH.3 (25mmL)
	15pc	Each 5pcs - 1/4" PZ.1; PZ.2; PZ.3 (25mmL)
	15pc	Each 5pcs - 1/4" 4; 5.5; 6.5 mm (25mmL)
	10pc	Each 2pcs - 1/4" 2; 3; 4; 5; 6 mm (25mmL)
	27pc	Each 3pcs - 1/4" T6; T8; T10; T15; T20; T25; T27; T30; T40 (25mmL)
	18pc	Each 2pcs - 1/4" T-6H; T-8H; T-10H; T-15H; T-20H; T-25H; T-27H; T-30H; T-40H (25mmL)
	1pc	Magnetic 1/4"Hex-1/4"Hex 2.3"(60mm)
	1pc	Magnetic QR 1/4"Hex-1/4"Hex 2.3"(60mm)

8pc 1/4" Star tamperproof bit & holder wrench set



2081 100/14.0/15.0/1.5' Δ 140g

	7pc	1/4" T-10H; T-15H; T-20H; T-25H; T-27H; T-30H; T-40H (30mmL)
	1pc	Offset bit holder wrench 4.3"(110mm) (8152105)

8pc 1/4" Bit & holder wrench set



2081A 100/14.0/15.0/1.5' Δ 140g

	3pc	1/4" PH.1; PH.2; PH.3 (30mmL)
	2pc	1/4" PZ.1; PZ.2 (30mmL)
	2pc	1/4" 4; 7 mm (30mmL)
	1pc	Offset bit holder wrench 4.3"(110mm) (8152105)

8pc 1/4" Hex bit & holder wrench set



2081B 100/14.0/15.0/1.5' Δ 140g

	7pc	1/4" 2; 3; 4; 5; 6; 7; 8 mm (30mmL)
	1pc	Offset bit holder wrench 4.3"(110mm) (8152105)

8pc 1/4" Bit & holder wrench set



2081C 100/14.0/15.0/1.5' Δ 140g

	3pc	1/4" PH.1; PH.2; PH.3 (30mmL)
	3pc	1/4" PZ.1; PZ.2; PZ.3 (30mmL)
	1pc	1/4" 7 mm (30mmL)
	1pc	Offset bit holder wrench 4.3"(110mm) (8152105)

8pc 1/4" Star bit & holder wrench set



2081D 100/14.0/15.0/1.5' Δ 140g

	7pc	1/4" T10; T15; T20; T25; T27; T30; T40 (30mmL)
	1pc	Offset bit holder wrench 4.3"(110mm) (8152105)

8pc 1/4" Bit & driver set



2083 60/14.4/15.4/3' Δ 240g

	2pc	1/4" PH.1; PH.2 (25mmL)
	2pc	1/4" PZ.1; PZ.2 (25mmL)
	2pc	1/4" 4; 5.5 mm (25mmL)
	1pc	Magnetic bit adapter 1/4"Hex-1/4"Sq. (8092225M)
	1pc	Flexible telescope bit driver 246-360mm (8146)

9pc 1/4" Double-sized bit & spinner handle set



20918 20/8.6/9.6/0.59' Δ 428g

	1pc	1/4" PH.1xPH.2 (165mmL)
	1pc	1/4" PZ.1xPZ.2 (165mmL)
	2pc	1/4" 3x4mm; 5.5x7mm (165mmL)
	4pc	1/4" T8xT10; T15xT20; T25xT27; T30xT40 (165mmL)
	1pc	1/4"inhex 5"(125mm) (8152)

22pc Mini ratchet bit handle set



2222 48/13.4/14.4/0.87' Δ 280g

	5pc	1/4"DR. 6; 7; 8; 10; 13 mm
	3pc	1/4" PH.1; PH.2; PH.3 (25mmL)
	3pc	1/4" 4; 5.5; 6.5 mm (25mmL)
	4pc	1/4" 3; 4; 5; 6 mm (25mmL)
	5pc	1/4" T10; T15; T20; T25; T30 (25mmL)
	1pc	Ratchet 1/4"inhex 5.1"(130mm) (802214)
	1pc	1/4"Hex-1/4"Sq. (25mmL)

26pc Ratchet bit spinner handle set



2263 10/14.0/15.0/1' Δ 1400g

	11pc	1/4"DR. 4; 4.5; 5; 5.5; 6; 7; 8; 9; 10; 11; 12 mm
	2pc	1/4" PH.1xPH.2; PH.3xPH.4 (165mmL)
	2pc	1/4" PZ.1xPZ.2; PZ.3xPZ.4 (165mmL)
	2pc	1/4" 3x4mm; 5.5x7mm (165mmL)
	2pc	1/4" 3x4mm; 5x6mm (165mmL)
	4pc	1/4" T8xT10; T15xT20; T25xT27; T30xT40 (165mmL)
	1pc	1/4"inhex-1/4"(M)
	1pc	Ratchet 1/4"inhex 8"(200mm) (8152R)
	1pc	Demagnetizer / Magnetizer (88601)

25pc Ratchet spinner set



2255 40/15.6/16.6/3.2' Δ 370g

	3pc	1/4" PH.1; PH.2; PH.3 (25mmL)
	3pc	1/4" PZ.1; PZ.2; PZ.3 (25mmL)
	5pc	1/4" 3; 4; 5; 5.5; 6.5 mm (25mmL)
	6pc	1/4" 3; 4; 5; 6; 7; 8 mm (25mmL)
	6pc	1/4" T-10H; T-15H; T-20H; T-25H; T-27H; T-30H (25mmL)
	1pc	Magnetic 1/4"DR.x1/4"(F)
	1pc	Ratchet 1/4"DR. 7.6"(193mm) (8149)

46pc Ratchet spinner set







K2463 24/17.8/18.8/1.5' Δ 740g

	13pc	Spline 1/4"DR. 4; 4.5; 5; 5.5; 6; 7; 8; 9; 10; 11; 12; 13; 14 mm
	4pc	1/4" PH.0; PH.1; PH.2; PH.3 (25mmL)
	4pc	1/4" PZ.0; PZ.1; PZ.2; PZ.3 (25mmL)
	5pc	1/4" 3; 4; 5; 5.5; 6.5 mm (25mmL)
	6pc	1/4" 3; 4; 5; 6; 7; 8 mm (25mmL)
	7pc	1/4" T-10H; T-15H; T-20H; T-25H; T-27H; T-30H; T-40H (25mmL)
	5pc	1/4" M4; M5; M6; M8; M10 (25mmL)
	1pc	Magnetic 1/4"DR.x1/4"(F)
	1pc	Ratchet 1/4"DR. 7.6"(193mm) (8149)

7pc 10mm Hex bit set







4075  100/14.0/15.0/3.1'  140g

	6pc	10mm 4; 5; 6; 8; 10; 12 mm (30mmL)
	1pc	1/2"DR.x10mm(F)

15pc 10mm Hex bit set







4155  20/16.0/17.0/0.82'  800g

	7pc	10mm 4; 5; 6; 7; 8; 10; 12 mm (30mmL)
	7pc	10mm 4; 5; 6; 7; 8; 10; 12 mm (75mmL)
	1pc	1/2"DR.x10mm(F)

7pc 5/16" Star bit set







3071  100/14.5/15.5/1.8'  145g

	6pc	5/16" T25; T30; T40; T45; T50; T55 (35mmL)
	1pc	3/8"DR.x5/16"(F)

7pc 10mm Star bit set







4074  100/14.0/15.0/3.1'  140g



	6pc	10mm T25; T30; T40; T45; T50; T55 (30mmL)
	1pc	1/2"DR.x10mm(F)

8pc 10mm Star bit set



4081  100/19.0/20.0/1.6'  190g

	7pc	10mm T20; T25; T30; T40; T45; T50; T55 (30mmL)
	1pc	1/2"DR.x10mm(F)



4081-3  100/19.0/20.0/1.6'  190g



Changed items



	1pc	3/8"DR.x10mm(F)
---	-----	-----------------

9pc 10mm Star bit set



3094  100/18.2/19.2/1.6'  182g

	8pc	10mm T20; T25; T30; T40; T45; T50; T55; T60 (30mmL)
	1pc	3/8"DR.x10mm(F)



NEW 3094-4  100/18.2/19.2/1.6'  182g



Changed items

	1pc	1/2"DR.x10mm(F)
---	-----	-----------------

15pc 10mm Star bit set







4156  20/16.0/17.0/0.82'  800g

	7pc	10mm T20; T25; T30; T40; T45; T50; T55 (30mmL)
	7pc	10mm T20; T25; T30; T40; T45; T50; T55 (75mmL)
	1pc	1/2"DR.x10mm(F)

22pc 10mm Star tamperproof bit set







4222  15/15.5/16.5/1'  1033g

	10pc	10mm T-10H; T-15H; T-20H; T-25H; T-27H; T-30H; T-40H; T-45H; T-50H; T-55H (30mmL)
	10pc	10mm T-10H; T-15H; T-20H; T-25H; T-27H; T-30H; T-40H; T-45H; T-50H; T-55H (75mmL)
	2pc	3/8"DR.x10mm(F); 1/2"DR.x10mm(F)

6pc 10mm Spline bit set







4066  100/13.0/14.0/3.1'  130g

	5pc	10mm M5; M6; M8; M10; M12 (30mmL)
	1pc	1/2"DR.x10mm(F)

7pc 10mm Spline bit set



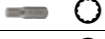



4072  60/16.5/17.5/1.3'  275g

	3pc	10mm M6; M8; M10 (30mmL)
	3pc	10mm M8; M10; M12 (75mmL)
	1pc	1/2"DR.x10mm(F)

11pc 10mm Spline bit set







4112  20/10.3/11.3/0.82'  515g

	5pc	10mm M5; M6; M8; M10; M12 (30mmL)
	5pc	10mm M5; M6; M8; M10; M12 (75mmL)
	1pc	1/2"DR.x10mm(F)

22pc 10mm Ribe bit set



4225  15/18.2/19.2/1'  1230g

	10pc	10mm M4; M5; M6; M7; M8; M9; M10; M12; M13; M14 (30mmL)
	10pc	10mm M4; M5; M6; M7; M8; M9; M10; M12; M13; M14 (75mmL)
	2pc	3/8"DR.x10mm(F); 1/2"DR.x10mm(F)

28pc 10mm Bit set









4283  15/18.0/19.0/1'  1200g

	7pc	10mm 4; 5; 6; 7; 8; 10; 12 mm (30mmL)
	4pc	10mm 5; 6; 8; 10 mm (75mmL)
	7pc	10mm T20; T25; T30; T40; T45; T50; T55 (30mmL)
	4pc	10mm M5; M6; M8; M10 (30mmL)
	4pc	10mm M6; M8; M10; M12 (75mmL)
	2pc	3/8"DR.x10mm(F); 1/2"DR.x10mm(F)

35pc Bit set

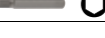

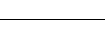
4351  10/22.5/23.5/0.7'  2500g

	7pc	10mm 4; 5; 6; 7; 8; 10; 12 mm (30mmL)
	7pc	10mm 4; 5; 6; 7; 8; 10; 12 mm (75mmL)
	7pc	10mm T20; T25; T30; T40; T45; T50; T55 (30mmL)
	2pc	14mm T60; T70 (50mmL)
	7pc	10mm T20; T25; T30; T40; T45; T50; T55 (75mmL)
	2pc	14mm T60; T70 (75mmL)
	3pc	3/8"DR.x10mm(F); 1/2"DR.x10mm(F); 1/2"DR.x14mm(F)

40pc 10mm Bit set



4401 10/20.0/21.0/0.8' 2000g

	7pc	10mm 4; 5; 6; 7; 8; 10; 12 mm (30mmL)
	7pc	10mm 4; 5; 6; 7; 8; 10; 12 mm (75mmL)
	7pc	10mm T20; T25; T30; T40; T45; T50; T55 (30mmL)
	7pc	10mm T20; T25; T30; T40; T45; T50; T55 (75mmL)
	5pc	10mm M5; M6; M8; M10; M12 (30mmL)
	5pc	10mm M5; M6; M8; M10; M12 (75mmL)
	2pc	3/8"DR.x10mm(F); 1/2"DR.x10mm(F)

4401T 10/20.0/21.0/0.8' 2000g

Changed items

	7pc	10mm T-20H; T-25H; T-30H; T-40H; T-45H; T-50H; T-55H (30mmL)
	7pc	10mm T-20H; T-25H; T-30H; T-40H; T-45H; T-50H; T-55H (75mmL)

42pc 10mm Bit set



4421 10/21.0/22.0/0.8' 2100g

	7pc	10mm 4; 5; 6; 7; 8; 10; 12 mm (30mmL)
	7pc	10mm 4; 5; 6; 7; 8; 10; 12 mm (75mmL)
	8pc	10mm T20; T25; T30; T40; T45; T50; T55; T60 (30mmL)
	8pc	10mm T20; T25; T30; T40; T45; T50; T55; T60 (75mmL)
	5pc	10mm M5; M6; M8; M10; M12 (30mmL)
	5pc	10mm M5; M6; M8; M10; M12 (75mmL)
	2pc	3/8"DR.x10mm(F); 1/2"DR.x10mm(F)

4421T 10/21.0/22.0/0.8' 2100g

Changed items

	8pc	10mm T-20H; T-25H; T-30H; T-40H; T-45H; T-50H; T-55H; T-60H (30mmL)
	8pc	10mm T-20H; T-25H; T-30H; T-40H; T-45H; T-50H; T-55H; T-60H (75mmL)

40pc 10mm Bit set



4401C 10/19.0/20.0/1' 1900g

	7pc	10mm 4; 5; 6; 7; 8; 10; 12 mm (30mmL)
	7pc	10mm 4; 5; 6; 7; 8; 10; 12 mm (75mmL)
	7pc	10mm T20; T25; T30; T40; T45; T50; T55 (30mmL)
	7pc	10mm T20; T25; T30; T40; T45; T50; T55 (75mmL)
	5pc	10mm M5; M6; M8; M10; M12 (30mmL)
	5pc	10mm M5; M6; M8; M10; M12 (75mmL)
	2pc	3/8"DR.x10mm(F); 1/2"DR.x10mm(F)

4401CT 10/19.0/20.0/1' 1900g

Changed items

	7pc	10mm T-20H; T-25H; T-30H; T-40H; T-45H; T-50H; T-55H (30mmL)
	7pc	10mm T-20H; T-25H; T-30H; T-40H; T-45H; T-50H; T-55H (75mmL)

42pc 10mm Bit set



4421C 10/20.0/21.0/1' 2000g

	7pc	10mm 4; 5; 6; 7; 8; 10; 12 mm (30mmL)
	7pc	10mm 4; 5; 6; 7; 8; 10; 12 mm (75mmL)
	8pc	10mm T20; T25; T30; T40; T45; T50; T55; T60 (30mmL)
	8pc	10mm T20; T25; T30; T40; T45; T50; T55; T60 (75mmL)
	5pc	10mm M5; M6; M8; M10; M12 (30mmL)
	5pc	10mm M5; M6; M8; M10; M12 (75mmL)
	2pc	3/8"DR.x10mm(F); 1/2"DR.x10mm(F)



4421CT 10/20.0/21.0/1' 2000g





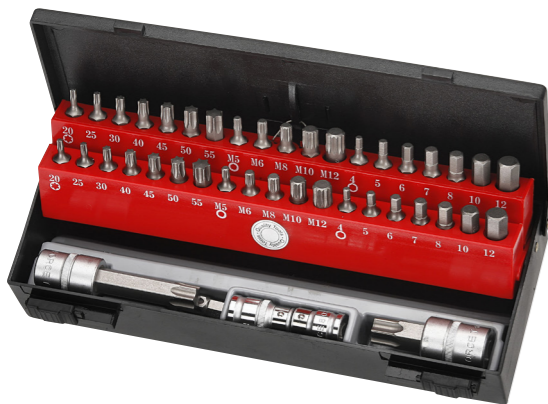

Changed items



	8pc	10mm T-20H; T-25H; T-30H; T-40H; T-45H; T-50H; T-55H; T-60H (30mmL)
	8pc	10mm T-20H; T-25H; T-30H; T-40H; T-45H; T-50H; T-55H; T-60H (75mmL)

44pc 10mm Bit set

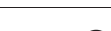

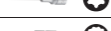

4441C  10/22.5/23.5/1'  2250g

	7pc	10mm 4; 5; 6; 7; 8; 10; 12 mm (30mmL)
	7pc	10mm 4; 5; 6; 7; 8; 10; 12 mm (75mmL)
	8pc	10mm T20; T25; T30; T40; T45; T50; T55; T60 (30mmL)
	8pc	10mm T20; T25; T30; T40; T45; T50; T55; T60 (75mmL)
	2pc	1/2"DR. T80 (70mmL); T70 (100mmL)
	5pc	10mm M5; M6; M8; M10; M12 (30mmL)
	5pc	10mm M5; M6; M8; M10; M12 (75mmL)
	2pc	3/8"DR.x10mm(F); 1/2"DR.x10mm(F)



4441CT  10/22.5/23.5/1'  2250g

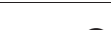



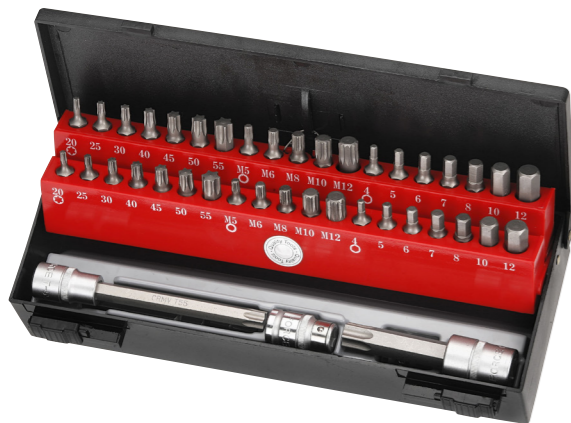



Changed items

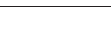

	8pc	10mm T-20H; T-25H; T-30H; T-40H; T-45H; T-50H; T-55H; T-60H (30mmL)
	8pc	10mm T-20H; T-25H; T-30H; T-40H; T-45H; T-50H; T-55H; T-60H (75mmL)
	2pc	1/2"DR. T-80H (70mmL); T-70H (100mmL)

44pc 10mm Bit set





4442C  10/22.0/23.0/1'  2200g

	7pc	10mm 4; 5; 6; 7; 8; 10; 12 mm (30mmL)
	7pc	10mm 4; 5; 6; 7; 8; 10; 12 mm (75mmL)
	8pc	10mm T20; T25; T30; T40; T45; T50; T55; T60 (30mmL)
	8pc	10mm T20; T25; T30; T40; T45; T50; T55; T60 (75mmL)
	2pc	1/2"DR. T70 (100mmL); T55 (140mmL)
	5pc	10mm M5; M6; M8; M10; M12 (30mmL)
	5pc	10mm M5; M6; M8; M10; M12 (75mmL)
	2pc	3/8"DR.x10mm(F); 1/2"DR.x10mm(F)



4442CT  10/22.0/23.0/1'  2200g









Changed items

	8pc	10mm T-20H; T-25H; T-30H; T-40H; T-45H; T-50H; T-55H; T-60H (30mmL)
	8pc	10mm T-20H; T-25H; T-30H; T-40H; T-45H; T-50H; T-55H; T-60H (75mmL)

58pc 10mm Bit & 1/2"DR. star socket set

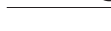

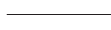



4583  6/16.6/17.6/0.9'  2766g

	10pc	1/2"DR. E8; E10; E11; E12; E14; E16; E18; E20; E22; E24
	7pc	10mm 4; 5; 6; 7; 8; 10; 12 mm (30mmL)
	7pc	10mm 4; 5; 6; 7; 8; 10; 12 mm (75mmL)
	9pc	10mm T20; T25; T27; T30; T40; T45; T50; T55; T60 (30mmL)
	9pc	10mm T20; T25; T27; T30; T40; T45; T50; T55; T60 (75mmL)
	7pc	10mm M5; M6; M7; M8; M9; M10; M12 (30mmL)
	7pc	10mm M5; M6; M7; M8; M9; M10; M12 (75mmL)
	2pc	3/8"DR.x10mm(F); 1/2"DR.x10mm(F)

6pc Screwdriver set







2068  10/6.3/7.3/1.1'  630g

	2pc	PH.1 (80mmL); PH.2 (100mmL)
	4pc	3mm (75mmL); 4mm (100mmL); 5.5mm (125mmL); 6.5mm (150mmL)

7pc Screwdriver set







20713  10/10.1/11.1/1.2'  1010g

	3pc	PH.1 (80mmL); PH.2 (100mmL); PH.3 (150mmL)
	4pc	4mm (100mmL); 5.5mm (125mmL); 6.5mm (150mmL); 8mm (175mmL)

8pc Screwdriver set



2084  10/8.2/9.2/0.95'  820g

	2pc	PH.1 (80mmL); PH.2 (100mmL)
	6pc	3mm (75mmL); 3.5mm (100mmL); 4mm (100mmL); 5.5mm (125mmL); 6.5mm (150mmL); 8mm (175mmL)

8pc Screwdriver set



2085 10/4.9/5.9/1.1' 490g

	1pc	PH.1 (25mmL)
	1pc	PH.0 (60mmL)
	1pc	PZ.1 (25mmL)
	3pc	PZ.0 (60mmL); PZ.1 (80mmL); PZ.2 (100mmL)
	2pc	5.5; 6.5 mm (25mmL)

9pc Screwdriver set



20915 10/8.0/9.0/1.3' 797g

	2pc	PH.1; PH.2 (25mmL)
	2pc	PH.1 (80mmL); PH.2 (100mmL)
	1pc	5.5mm (25mmL)
	4pc	3mm (75mmL); 4mm (100mmL); 5.5mm (125mmL); 6.5mm (150mmL)

14pc Screwdriver set



2142 6/8.0/9.0/1.3' 1333g

	2pc	PH.1; PH.2 (25mmL)
	4pc	PH.0 (60mmL); PH.1 (80mmL); PH.2 (100mmL); PH.3 (150mmL)
	2pc	5.5; 6.5 mm (25mmL)
	6pc	3mm (75mmL); 3.5mm (100mmL); 4mm (100mmL); 5.5mm (125mmL); 6.5mm (150mmL); 8mm (175mmL)

14pc Screwdriver set



2143 6/8.2/9.2/1.3' 1370g

	2pc	PZ.1; PZ.2 (25mmL)
	4pc	PZ.0 (60mmL); PZ.1 (80mmL); PZ.2 (100mmL); PZ.3 (150mmL)
	2pc	5.5; 6.5 mm (25mmL)
	6pc	3mm (75mmL); 3.5mm (100mmL); 4mm (100mmL); 5.5mm (125mmL); 6.5mm (150mmL); 8mm (175mmL)

14pc Screwdriver set



21410 4/8.8/9.8/1.3' 2310g

	1pc	PH.2 (25mmL)
	4pc	PH.0 (60mmL); PH.1 (80mmL); PH.2 (100mmL); PH.3 (150mmL)
	1pc	6.5mm (25mmL)
	5pc	3mm (75mmL); 4mm (100mmL); 5.5mm (125mmL); 6.5mm (150mmL); 8mm (175mmL)
	1pc	Hammer 10mm (200mmL)
	1pc	Insulated 5.5mm (125mmL)
	1pc	Demagnetizer / Magnetizer (88601)

6pc Hammer screwdriver set



2069 10/12.3/13.3/1.3' 1225g

	3pc	PH.1 (80mmL); PH.2 (100mmL); PH.3 (150mmL)
	3pc	5.5mm (125mmL) 6.5; 8mm (150mmL)

6pc Hammer screwdriver set

NEW



20610A 10/14.4/15.4/1.3' 1440g

	1pc	PH.2 (100mmL)
	5pc	5.5mm (125mmL); 6.5mm (150mmL); 8mm (150mmL); 10mm (200mmL); 12mm (200mmL)

7pc Hammer screwdriver set



20714		10/12.0/13.0/1.2'		1200g
	3pc	PH.1 (80mmL); PH.2 (100mmL); PH.3 (150mmL)		4pc
		5.5mm (125mmL); 6.5mm (150mmL); 8mm (150mmL); 10mm (200mmL)		

10pc Hammer screwdriver set



2108		6/14.4/15.4/1.3'		2400g
	4pc	PH.1 (80mmL); PH.2 (100mmL); PH.3 (150mmL); PH.4 (200mmL)		6pc
		5.5mm (125mmL); 6.5mm (150mmL); 8mm (150mmL); 10mm (200mmL); 12mm (200mmL); 14mm (250mmL)		

10pc Hammer screwdriver set



2109		6/14.4/15.4/1.3'		2400g
	4pc	PZ.1 (80mmL); PZ.2 (100mmL); PZ.3 (150mmL); PZ.4 (200mmL)		6pc
		5.5mm (125mmL); 6.5mm (150mmL); 8mm (150mmL); 10mm (200mmL); 12mm (200mmL); 14mm (250mmL)		

8pc Hex screwdriver set



20810		10/8.8/9.8/1.1'		880g
	8pc	2; 2.5; 3; 4; 5 mm (100mmL); 6mm (125mmL); 8mm (150mmL); 10mm (150mmL)		

8pc Hex ball screwdriver set



20810B		10/8.6/9.6/1.1'		860g
	8pc	2; 2.5; 3; 4; 5 mm (100mmL); 6mm (125mmL); 8mm (150mmL); 10mm (150mmL)		

4pc Star screwdriver set



2044		60/9.0/10.0/2.5'		150g
	4pc	T6; T7; T8; T9 (100mmL)		

2044S		60/9.0/10.0/2.5'		150g
	4pc	T6; T7; T8; T9 (60mmL)		

4pc Star screwdriver set



2048		30/12.1/13.1/2.2'		403g
	4pc	T15 (80mmL); T20 (100mmL); T25 (100mmL); T30 (115mmL)		

6pc Star screwdriver set

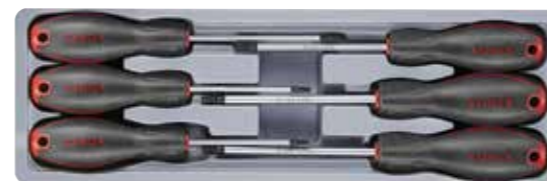

2061		30/17.8/18.8/2.2'		593g
	6pc	T10; T15 (80mmL); T20; T25 (100mmL); T27; T30 (115mmL)		



8pc Star screwdriver set



2086		10/7.5/8.5/0.95'		750g
	8pc	T8 (60mmL); T10 (80mmL); T15 (80mmL); T20 (100mmL); T25 (100mmL); T27 (115mmL); T30 (115mmL); T40 (130mmL)		

11pc Star screwdriver set





2119  20/20.2/21.2/2.6'  1010g

 11pc	T6; T7; T8; T9 (60mmL)
	T10; T15 (80mmL)
	T20; T25 (100mmL)
	T27; T30 (115mmL)
	T40 (130mmL)

13pc Star screwdriver set





2137  6/7.9/8.9/1.3'  1317g

 13pc	T5; T6; T7; T8; T9 (60mmL)
	T10; T15 (80mmL)
	T20; T25 (100mmL)
	T27; T30 (115mmL)
	T40; T45 (130mmL)

7pc Extra-long star screwdriver set





20719  10/10.3/11.3/1.3'  1030g

 7pc	T10; T15; T20; T25; T27; T30; T40 (300mmL)
---	--

4pc Star tamperproof screwdriver set





2044ST  60/9.0/10.0/2.5'  150g

 4pc	T-6H; T-7H; T-8H; T-9H (60mmL)
---	--------------------------------

4pc Star tamperproof screwdriver set





2048T  30/12.1/13.1/2.2'  403g

 4pc	T-15H (80mmL); T-20H (100mmL); T-25H (100mmL); T-30H (115mmL)
---	--

6pc Star tamperproof screwdriver set





2061T  30/12.5/13.5/2.2'  415g

 6pc	T-10H; T-15H (80mmL) T-20H; T-25H (100mmL) T-27H; T-30H (115mmL)
---	--

8pc Star tamperproof screwdriver set





2086T  10/7.6/8.6/0.95'  750g

 8pc	T-8H (60mmL); T-10H (80mmL); T-15H (80mmL); T-20H (100mmL); T-25H (100mmL); T-27H (115mmL); T-30H (115mmL); T-40H (130mmL)
---	---

11pc Star tamperproof screwdriver set





2119T  20/20.2/21.2/2.6'  1010g

 11pc	T-6H; T-7H; T-8H; T-9H (60mmL) T-10H; T-15H (80mmL) T-20H; T-25H (100mmL) T-27H; T-30H (115mmL) T-40H (130mmL)
--	--

13pc Star tamperproof screwdriver set



2137T  6/7.3/8.3/1.3'  1217g

 13pc	T-5H; T-6H; T-7H; T-8H; T-9H (60mmL) T-10H; T-15H (80mmL) T-20H; T-25H (100mmL) T-27H; T-30H (115mmL) T-40H; T-45H (130mmL)
--	---

7pc Five-sided star tamperproof screwdriver set



20717	10/13.0/14.0/1.2'	1300g
7pc	TS10; TS15; TS20; TS25; TS27 (150mmL) TS30; TS40 (150mmL)	

6pc Hex socket driver set

NEW



20612	10/11.2/12.2/1.3'	1120g
6pc	6; 7; 8; 10; 12; 13 mm (135mmL)	

13pc Hex socket driver set



2134	6/11.0/12.0/1.3'	1833g
13pc	4; 4.5; 5; 5.5; 6; 7; 8; 9; 10 (135mmL) 11; 12; 13; 14 mm (135mmL)	

6pc Extra-long screwdriver set



20611	10/11.5/12.5/2'	1150g
2pc	PH.1; PH.2 (350mmL)	
4pc	4; 5; 6; 8 mm (300mmL)	

7pc Insulated screwdriver set



20712N	10/6.3/7.3/0.95'	640g
2pc	PH.1 (80mmL); PH.2 (100mmL)	
4pc	3mm (100mmL); 4mm (100mmL); 5.5mm (125mmL); 6.5mm (150mmL)	
1pc	Adjustable non-contact wire tracer (88407)	

7pc Insulated screwdriver set



20715N	10/6.0/7.0/1.1'	600g
2pc	PH.1 (80mmL); PH.2 (100mmL)	
5pc	2.5mm (75mmL); 3mm (100mmL); 4mm (100mmL); 5.5mm (125mmL); 6.5mm (150mmL)	

7pc Insulated screwdriver set



20718N	10/6.8/7.8/1.1'	675g
2pc	PH.1 (80mmL); PH.2 (100mmL)	
4pc	2.5mm (75mmL); 3.5mm (100mmL); 5.5mm (125mmL); 6.5mm (150mmL)	
1pc	Screwdriver probe voltage tester (88401)	

7pc Insulated screwdriver set



20718N-3	10/6.8/7.8/1.1'	683g
2pc	PH.1 (80mmL); PH.2 (100mmL)	
4pc	2.5mm (75mmL); 3.5mm (100mmL); 5.5mm (125mmL); 6.5mm (150mmL)	
1pc	Screwdriver probe voltage tester (88403)	



9pc Insulated screwdriver set





20916N	10/14.0/15.0/1.2'	1400g
2pc	PH.1 (80mmL); PH.2 (100mmL)	
6pc	2.5mm (75mmL); 3mm (100mmL); 3.5mm (100mmL); 4mm (100mmL); 5.5mm (125mmL); 6.5mm (150mmL)	
1pc	Screwdriver probe voltage tester (88401)	

12pc Insulated screwdriver set







2125N  6/7.5/8.5/1.3'  1250g

	4pc	PH.0 (60mmL); PH.1 (80mmL); PH.2 (100mmL); PH.3 (150mmL)
	7pc	2.5mm (75mmL); 3mm (100mmL); 3.5mm (100mmL); 4mm (100mmL); 5.5mm (125mmL); 6.5mm (150mmL); 8mm (175mmL)
	1pc	Adjustable non-contact wire tracer (88407)

12pc Insulated screwdriver set





2126N  6/6.5/7.5/1.3'  1083g

	4pc	PZ.0 (60mmL); PZ.1 (80mmL); PZ.2 (100mmL); PZ.3 (150mmL)
	7pc	2.5mm (75mmL); 3mm (100mmL); 3.5mm (100mmL); 4mm (100mmL); 5.5mm (125mmL); 6.5mm (150mmL); 8mm (175mmL)
	1pc	Adjustable non-contact wire tracer (88407)

6pc Insulated hex socket driver set

NEW





20612N  10/10.6/11.6/1.3'  1060g

	6pc	6; 7; 8; 10; 12; 13 mm (125mmL)
---	-----	---------------------------------

9pc Insulated hex socket driver set

NEW







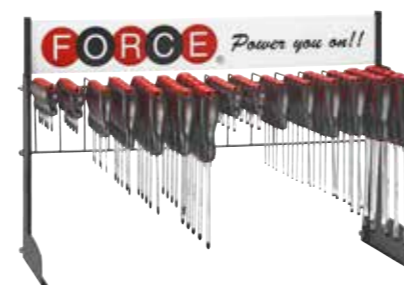

20917  6/11.0/12.0/1.3'  1833g

	9pc	5; 6; 7; 8; 9; 10; 11; 12; 13 mm (125mmL)
---	-----	---

75pc Screwdriver set







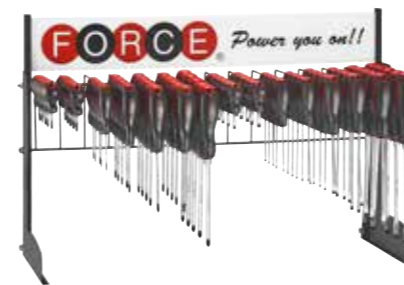

2751  2/16.4/17.4/1.4'  8200g

	10pc	Each	5pcs PH.1; PH.2 (25mmL)
	15pc	Each	5pcs PH.0 (60mmL); PH.1 (80mmL); PH.3 (150mmL)
	10pc	Each	10pcs PH.2 (100mmL)
	10pc	Each	5pcs 5.5; 6.5 mm (25mmL)
	30pc	Each	5pcs 3mm (75mmL); 3.5mm (100mmL); 4mm (100mmL); 5.5mm (125mmL); 6.5mm (150mmL); 8mm (175mmL)

75pc Screwdriver set







2752  2/16.4/17.4/1.4'  8200g

	10pc	Each	5pcs PZ.1; PZ.2 (25mmL)
	15pc	Each	5pcs PZ.0 (60mmL); PZ.1 (80mmL); PZ.3 (150mmL)
	10pc	Each	10pcs PZ.2 (100mmL)
	10pc	Each	5pcs 5.5; 6.5 mm (25mmL)
	30pc	Each	5pcs 3mm (75mmL); 3.5mm (100mmL); 4mm (100mmL); 5.5mm (125mmL); 6.5mm (150mmL); 8mm (175mmL)

75pc Star screwdriver set







2753  2/16.4/17.4/1.4'  8200g

	55pc	Each	5pcs T5; T6; T7; T8; T9 (60mmL) T20; T25 (100mmL) T27; T30 (115mmL) T40; T45 (130mmL)
	20pc	Each	10pcs T10; T15 (80mmL)

75pc Star tamperproof screwdriver set



2753T  2/16.4/17.4/1.4'  8200g

	55pc	Each	5pcs T-5H; T-6H; T-7H; T-8H; T-9H (60mmL) T-20H; T-25H (100mmL) T-27H; T-30H (115mmL) T-40H; T-45H (130mmL)
	20pc	Each	10pcs T-10H; T-15H (80mmL)

8pc Jeweler screwdriver set

NEW



2087A

40/11.5/12.5/1.3' Δ 287g

	3pc	PH.00; PH.0; PH.1 (75mmL)
	5pc	2.0; 2.5; 3.0; 3.5; 4.0 mm (75mmL)

8pc Star tamperproof jeweler screwdriver set

NEW



2088AT

40/10.8/11.8/1.3' Δ 270g

	4pc	T-5H; T-6H; T-7H; T-8H (40mmL)
	4pc	T-9H; T-10H; T-15H; T-20H (75mmL)

11pc Jeweler screwdriver set

NEW



2106A

20/13.5/14.5/2.4' Δ 675g

	3pc	PH.000; PH.00; PH.0 (40mmL)
	5pc	1.2; 1.5; 1.8; 2.0; 2.5 mm (40mmL)
	1pc	5.5" (140mm)
	1pc	4.7" (118mm)
	1pc	5.5" (140mm) (6945140)

17pc Jeweler screwdriver & (de-)magnetizer set

NEW

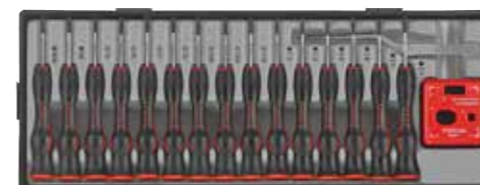

T2173A

6/3.6/4.6/0.72' Δ 586g

	2pc	PH.000; PH.00 (40mmL)
	6pc	1.0; 1.2; 1.5; 1.8; 2.0; 2.5 mm (40mmL)
	4pc	T5; T6; T7; T8 (40mmL)
	3pc	T-5H; T-6H; T-7H (40mmL)
	1pc	5.5" (140mm) (6945140)
	1pc	Demagnetizer / Magnetizer (88601)

8pc Star jeweler screwdriver set

NEW



2088A

40/10.8/11.8/1.3' Δ 270g

	4pc	T5; T6; T7; T8 (40mmL)
	4pc	T9; T10; T15; T20 (75mmL)

7pc Hex key set (folding)



5076F

100/15.0/16.0/1.6' Δ 150g

	7pc	1.5; 2; 2.5; 3; 4; 5; 6 mm
--	-----	----------------------------

7pc Hex key set



5076

100/9.6/10.6/1' Δ 100g

	7pc	1.5; 2; 2.5; 3; 4; 5; 6 mm
--	-----	----------------------------

7pc Long hex key set

NEW



5076L 100/12.0/13.0/1' 120g
 7pc 1.5; 2; 2.5; 3; 4; 5; 6 mm

7pc Extra long hex key set

5072XL 40/18.2/19.2/1.1' 450g
 7pc 2.5; 3; 4; 5; 6; 8; 10 mm



7pc Extra long hex key set

NEW

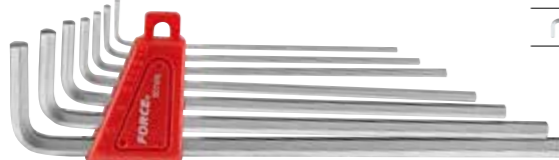

5076XL 100/15.0/16.0/1.2' 150g
 7pc 1.5; 2; 2.5; 3; 4; 5; 6 mm

9pc Hex key set

5093 50/15.0/16.0/1.3' 300g
 9pc 1.5; 2; 2.5; 3; 4; 5; 6; 8; 10 mm



7pc Hex key set (folding)



5072F 40/17.0/18.0/1.2' 425g
 7pc 2.5; 3; 4; 5; 6; 8; 10 mm

9pc Long hex key set

5093L 50/20.8/21.8/2.2' 416g
 9pc 1.5; 2; 2.5; 3; 4; 5; 6; 8; 10 mm



7pc Hex key set



5072 60/16.2/17.2/1.1' 270g
 7pc 2.5; 3; 4; 5; 6; 8; 10 mm

9pc Extra long hex key set

5093XL 40/20.1/21.1/2.1' 502g
 9pc 1.5; 2; 2.5; 3; 4; 5; 6; 8; 10 mm



7pc Long hex key set



5072L 50/18.5/19.5/1' 370g
 7pc 2.5; 3; 4; 5; 6; 8; 10 mm

10pc Hex key set



5102 50/15.3/16.3/1.3' 306g
 10pc 1.27; 1.5; 2; 2.5; 3; 4; 5; 6; 8; 10 mm

10pc Long hex key set



5102L 50/20.9/21.9/2.2' Δ 418g
 10pc 1.27; 1.5; 2; 2.5; 3; 4; 5; 6; 8; 10 mm

10pc Extra long hex key set



5102XL 40/20.1/21.1/2.1' Δ 502g
 10pc 1.27; 1.5; 2; 2.5; 3; 4; 5; 6; 8; 10 mm

11pc Hex key set

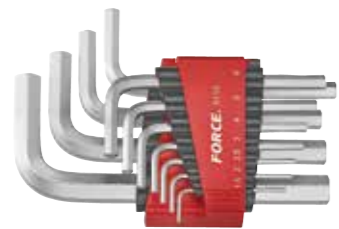

5116 40/21.7/22.7/1.5' Δ 542g
 11pc 1.5; 2; 2.5; 3; 4; 5; 6; 7; 8; 10; 12 mm

11pc Long hex key set

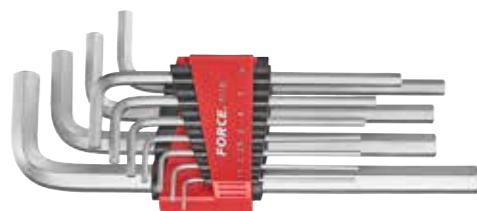

5116L 30/22.3/23.3/2' Δ 743g
 11pc 1.5; 2; 2.5; 3; 4; 5; 6; 7; 8; 10; 12 mm

11pc Extra long hex key set



5116XL 30/26.1/27.1/2.4' Δ 870g
 11pc 1.5; 2; 2.5; 3; 4; 5; 6; 7; 8; 10; 12 mm

13pc Hex key set

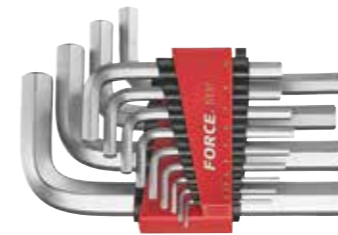

5137 12/23.4/24.4/1.66' Δ 1950g
 13pc 2; 2.5; 3; 4; 5; 6; 7; 8; 10; 12; 14; 17; 19 mm

13pc Extra long hex key set



5137XL 6/18.2/19.2/0.68' Δ 3030g
 13pc 2; 2.5; 3; 4; 5; 6; 7; 8; 10; 12; 14; 17; 19 mm

7pc Hex key set (folding) (SAE)



5076FS 100/15.0/16.0/1.6' Δ 150g
 7pc 1/16"; 5/64"; 3/32"; 1/8"; 5/32"; 3/16"; 1/4"

7pc Hex key set (SAE)



5076S 100/9.6/10.6/1' Δ 100g
 7pc 1/16"; 5/64"; 3/32"; 1/8"; 5/32"; 3/16"; 1/4"

7pc Hex key set (folding) (SAE)



5072FS 40/17.0/18.0/1.2' Δ 425g
 7pc 3/32"; 1/8"; 5/32"; 3/16"; 1/4"; 5/16"; 3/8"

7pc Hex key set (SAE)



5072S		60/15.7/16.7/1.1'		261g
	7pc	3/32"; 1/8"; 5/32"; 3/16"; 1/4"; 5/16"; 3/8"		

7pc Long hex key set (SAE)



5072LS		50/17.8/18.8/1'		356g
	7pc	3/32"; 1/8"; 5/32"; 3/16"; 1/4"; 5/16"; 3/8"		

7pc Extra long hex key set (SAE)



5072XLS		40/18.3/19.3/1.1'		458g
	7pc	3/32"; 1/8"; 5/32"; 3/16"; 1/4"; 5/16"; 3/8"		

9pc Hex key set (SAE)

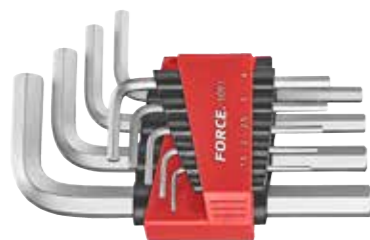

5093S		50/14.6/15.6/1.3'		292g
	9pc	1/16"; 5/64"; 3/32"; 1/8"; 5/32"; 3/16"; 1/4"; 5/16"; 3/8"		

9pc Long hex key set (SAE)

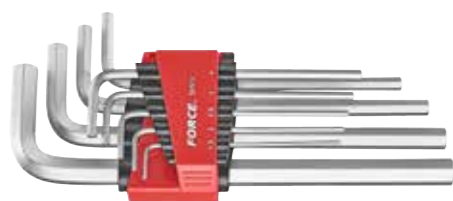

5093LS		50/20.2/21.2/2.2'		400g
	9pc	1/16"; 5/64"; 3/32"; 1/8"; 5/32"; 3/16"; 1/4"; 5/16"; 3/8"		

9pc Extra long hex key set (SAE)



5093XLS		40/20.1/21.1/2.1'		502g
	9pc	1/16"; 5/64"; 3/32"; 1/8"; 5/32"; 3/16"; 1/4"; 5/16"; 3/8"		

10pc Hex key set (SAE)



5109S		60/27.0/28.0/2.5'		450g
	10pc	1/16"; 5/64"; 3/32"; 1/8"; 5/32"; 3/16"; 1/4"; 5/16"; 3/8"; 1/2"		

13pc Hex key set (SAE)

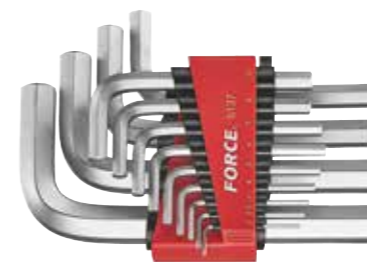

5137S		12/23.4/24.4/1.66'		1950g
	13pc	1/16"; 5/64"; 3/32"; 1/8"; 5/32"; 3/16"; 1/4"; 5/16"; 3/8"; 1/2"; 9/16"; 5/8"; 3/4"		

13pc Extra long hex key set (SAE)







5137XLS		6/18.2/19.2/0.68'		3030g
	13pc	1/16"; 5/64"; 3/32"; 1/8"; 5/32"; 3/16"; 1/4"; 5/16"; 3/8"; 1/2"; 9/16"; 5/8"; 3/4"		

14pc Jumbo hex key set (S&M)

NEW





5146  4/15.5/16.5/0.85'  3884g

	8pc	8; 10; 12; 13; 14; 16; 17; 19 (3/4") mm
	6pc	5/16"; 3/8"; 7/16"; 1/2"; 9/16"; 5/8"

7pc Hex ball point key set (folding)





5072BF  40/17.0/18.0/1.2'  425g

	7pc	2.5; 3; 4; 5; 6; 8; 10 mm
---	-----	---------------------------

7pc Long hex ball point key set





5072LB  50/18.5/19.5/1'  370g

	7pc	2.5; 3; 4; 5; 6; 8; 10 mm
---	-----	---------------------------

7pc Extra long hex ball point key set





5072XLB  40/18.2/19.2/1.1'  455g

	7pc	2.5; 3; 4; 5; 6; 8; 10 mm
---	-----	---------------------------

9pc Long hex ball point key set





5093LB  50/20.8/21.8/2.2'  416g

	9pc	1.5; 2; 2.5; 3; 4; 5; 6; 8; 10 mm
---	-----	-----------------------------------

9pc Extra long hex ball point key set





5093XLB  40/20/21/2.1'  500g

	9pc	1.5; 2; 2.5; 3; 4; 5; 6; 8; 10 mm
---	-----	-----------------------------------

10pc Long hex ball point key set





5102LB  50/20.9/21.9/2.2'  418g

	10pc	1.27; 1.5; 2; 2.5; 3; 4; 5; 6; 8; 10 mm
---	------	---

10pc Extra long hex ball point key set





5102XLB  40/20.9/21.9/2.1'  522g

	10pc	1.27; 1.5; 2; 2.5; 3; 4; 5; 6; 8; 10 mm
--	------	---

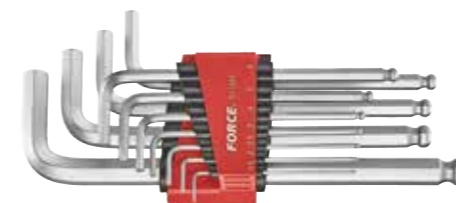
11pc Long hex ball point key set





5116LB  30/22.3/23.3/2'  743g

	11pc	1.5; 2; 2.5; 3; 4; 5; 6; 7; 8; 10; 12 mm
---	------	--

11pc Extra long hex ball point key set

NEW







5116XLB  30/26/27/2.4'  865g

	11pc	1.5; 2; 2.5; 3; 4; 5; 6; 7; 8; 10; 12 mm
---	------	--





7pc Long hex ball point key set (SAE)



5072LBS  50/17.8/18.8/1'  356g
  7pc 3/32"; 1/8"; 5/32"; 3/16"; 1/4"; 5/16"; 3/8"





7pc Extra long hex ball point key set (SAE)



5072XLBS  40/17.5/18.5/1.1'  438g
  7pc 3/32"; 1/8"; 5/32"; 3/16"; 1/4"; 5/16"; 3/8"





9pc Long hex ball point key set (SAE)



5093LBS  50/20.1/21.1/2.2'  402g
  9pc 1/16"; 5/64"; 3/32"; 1/8"; 5/32"; 3/16"; 1/4"; 5/16"; 3/8"





9pc Extra long hex ball point key set (SAE)



5093XLBS  40/20.1/21.1/2.1'  502g
  9pc 1/16"; 5/64"; 3/32"; 1/8"; 5/32"; 3/16"; 1/4"; 5/16"; 3/8"



10pc Extra long hex ball point key set (SAE)



5109XLBS  30/24.5/25.5/2.4'  816g
  10pc 1/16"; 5/64"; 3/32"; 1/8"; 5/32"; 3/16"; 1/4"; 5/16"; 3/8"; 1/2"





6pc Long star key set



50621L  200/8.0/9.0/0.32'  42g
 6pc T6; T7; T8; T9; T10; T15



8pc Star key set (folding)



5087F  100/13.0/14.0/1.6'  130g
  8pc T5; T6; T7; T8; T9; T10; T15; T20



6pc Star key set



5063  48/24.3/25.3/0.9'  500g
 6pc T40; T45; T47; T50; T55; T60





7pc Star key set



5071  80/11.0/12.0/0.8'  138g
 7pc T10; T15; T20; T25; T27; T30; T40

8pc Star key set (folding)



5083F  40/13.5/14.5/1.2'  338g
  8pc T9; T10; T15; T20; T25; T27; T30; T40

9pc Star key set



5091		30/14.3/15.3/0.9'		472g
		9pc	T10; T15; T20; T25; T27; T30; T40; T45; T50 (766 10K...50K)	

9pc Star key set



5098		80/21.0/22.0/1.9'		263g
		9pc	T10; T15; T20; T25; T27; T30; T40; T45; T50	

9pc Long star key set



5098L		50/18.2/19.2/2.2'		364g
		9pc	T10; T15; T20; T25; T27; T30; T40; T45; T50	

9pc Extra long star key set

NEW



5098XL		40/19.8/20.8/2.1'		450g
		9pc	T10; T15; T20; T25; T27; T30; T40; T45; T50	

9pc Long star key set



5099L		30/22.0/23.0/0.7'		736g
		9pc	T20; T25; T27; T30; T40; T45; T50; T55; T60	

15pc Star key set



5151		20/13.4/14.4/1.2'		670g
		15pc	T6; T7; T8; T9; T10; T15; T20; T25; T27; T30; T40; T45; T50; T55; T60	

15pc Long star key set



5151L		20/20.5/21.5/2.9'		1025g
		15pc	T6; T7; T8; T9; T10; T15; T20; T25; T27; T30; T40; T45; T50; T55; T60	

9pc Long star & star ball point key set



5098LB		50/18.2/19.2/2.2'		364g
		9pc	T10; T15; T20; T25; T27; T30; T40; T45; T50	

8pc Star tamperproof key set (folding)



5087TF		100/13.0/14.0/1.6'		130g
		8pc	T-5H; T-6H; T-7H; T-8H; T-9H; T-10H; T-15H; T-20H	

6pc Star tamperproof key set



5063T		48/24.0/25.0/0.9'		500g
		6pc	T-40H; T-45H; T-47H; T-50H; T-55H; T-60H	

7pc Star tamperproof key set



5071T 80/11.0/12.0/0.8' Δ 138g
 7pc T-10H; T-15H; T-20H; T-25H; T-27H; T-30H; T-40H

8pc Star tamperproof key set (folding)



5083TF 40/13.5/14.5/1.2' Δ 338g
 8pc T-9H; T-10H; T-15H; T-20H; T-25H; T-27H; T-30H; T-40H

9pc Star tamperproof key set



5092 30/13.9/14.9/0.9' Δ 470g
 9pc T-10H; T-15H; T-20H; T-25H; T-27H; T-30H; T-40H; T-45H; T-50H (767 10KG...50KG)

9pc Star tamperproof key set



5098T 80/21.2/22.2/1.9' Δ 265g
 9pc T-10H; T-15H; T-20H; T-25H; T-27H; T-30H; T-40H; T-45H; T-50H

9pc Long star tamperproof key set



5098LT 50/19.4/20.4/2.2' Δ 388g
 9pc T-10H; T-15H; T-20H; T-25H; T-27H; T-30H; T-40H; T-45H; T-50H

9pc Extra long star tamperproof key set



5098XLT 40/19.8/20.8/2.1' Δ 450g
 9pc T-10H; T-15H; T-20H; T-25H; T-27H; T-30H; T-40H; T-45H; T-50H

9pc Long star tamperproof key set



5099LT 30/22.0/23.0/0.7' Δ 733g
 9pc T-20H; T-25H; T-27H; T-30H; T-40H; T-45H; T-50H; T-55H; T-60H

15pc Star tamperproof key set



5151T 20/11.7/12.7/1.2' Δ 585g
 15pc T-6H; T-7H; T-8H; T-9H; T-10H; T-15H; T-20H; T-25H; T-27H; T-30H; T-40H; T-45H; T-50H; T-55H; T-60H

15pc Long star tamperproof key set



5151LT 20/20.3/21.3/2.9' Δ 1015g
 15pc T-6H; T-7H; T-8H; T-9H; T-10H; T-15H; T-20H; T-25H; T-27H; T-30H; T-40H; T-45H; T-50H; T-55H; T-60H

9pc Five-sided star tamperproof key set



50913 80/20.7/21.7/1.9' Δ 259g
 9pc TS10; TS15; TS20; TS25; TS27; TS30; TS40; TS45; TS50

5pc Spline key set



5501 30/15.5/16.5/0.9' 516g

	5pc	M5; M6; M8; M10; M12 (768 05K...12K)
--	-----	--------------------------------------

30pc L key and five-sided star tamperproof bit set

NEW



T5303 6/7.2/8.2/0.66' 1192g

	10pc	1/4" TS8; TS10; TS15; TS20; TS25; TS27; TS30; TS40; TS45; TS50 (25mmL) (21013)
	1pc	1/4"DR.x1/4"(F)
	10pc	1.27; 1.5; 2; 2.5; 3; 4; 5; 6; 8; 10 mm (5102XLB)
	9pc	T10; T15; T20; T25; T27; T30; T40; T45; T50 (5098XL)

29pc L key and five-sided star tamperproof bit set (SAE)

NEW



T5303S 6/7.2/8.2/0.66' 1192g

	10pc	1/4" TS8; TS10; TS15; TS20; TS25; TS27; TS30; TS40; TS45; TS50 (25mmL) (21013)
	1pc	1/4"DR.x1/4"(F)
	9pc	1/16"; 5/64"; 3/32"; 1/8"; 5/32"; 3/16"; 1/4"; 5/16"; 3/8" (5093XLBS)
	9pc	T10; T15; T20; T25; T27; T30; T40; T45; T50 (5098XL)

6pc Hex & hex ball point grip key set



50637 10/6.1/7.1/1.3' 612g

	6pc	2; 3; 4; 5; 6; 8 mm
--	-----	---------------------

10pc Hex & hex ball point grip key set



5106B 6/8.2/9.2/1.3' 1366g

	10pc	2; 2.5; 3; 4; 5; 6; 7; 8; 10; 12 mm
--	------	-------------------------------------

9pc Hex & hex ball point grip key set (SAE)

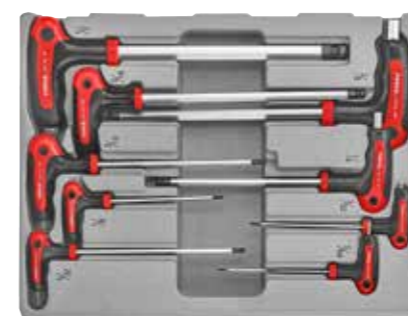

50910BS 6/8.0/9.0/1.3' 1330g

	9pc	5/64"; 3/32"; 1/8"; 5/32"; 3/16"; 1/4"; 5/16"; 3/8"; 1/2"
--	-----	---

6pc Star & star tamperproof grip key set

NEW



50636 10/5.5/6.5/1.3' 552g

	6pc	T10xT-10H; T15xT-15H; T20xT-20H; T25xT-25H; T27xT-27H; T30xT-30H
--	-----	--

10pc Star & star tamperproof grip key set

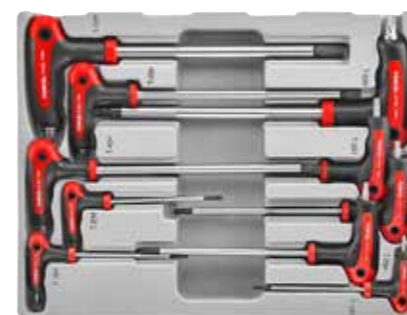

51010T 6/9.2/10.2/1.3' 1533g

	10pc	T10xT-10H; T15xT-15H; T20xT-20H; T25xT-25H; T27xT-27H; T30xT-30H; T40xT-40H; T45xT-45H; T50xT-50H; T55xT-55H
--	------	--

5pc T-handle hex key set



2057		5pc	3; 4; 5; 6; 8 mm		10/3.3/4.3/0.69"		330g
-------------	--	-----	------------------	--	------------------	--	------

9pc T-handle hex key set



2097		9pc	2; 2.5; 3; 4; 5; 6; 7; 8; 10 mm		6/7.0/8.0/1.3"		1166g
-------------	--	-----	---------------------------------	--	----------------	--	-------

2097S		9pc	3/32"; 7/64"; 1/8"; 5/32"; 3/16"; 7/32"; 1/4"; 5/16"; 3/8"		6/7.0/8.0/1.3"		1166g
--------------	--	-----	--	--	----------------	--	-------

9pc T-handle hex ball point key set



2097B		9pc	2; 2.5; 3; 4; 5; 6; 7; 8; 10 mm		6/7.0/8.0/1.3"		1166g
--------------	--	-----	---------------------------------	--	----------------	--	-------

5pc T-handle star key set



2058		5pc	T10; T15; T20; T25; T30		10/5.2/6.2/0.69"		520g
-------------	--	-----	-------------------------	--	------------------	--	------

14pc T-handle star key set



2141		14pc	T6; T7; T8; T9; T10; T15; T20; T25; T27; T30; T40; T45; T50; T55		6/8.5/9.5/2.4"		1415g
-------------	--	------	--	--	----------------	--	-------

14pc T-handle star tamperproof key set



2141T		14pc	T-6H; T-7H; T-8H; T-9H; T-10H; T-15H; T-20H; T-25H; T-27H; T-30H; T-40H; T-45H; T-50H; T-55H		6/8.5/9.5/2.4"		1415g
--------------	--	------	--	--	----------------	--	-------

5pc T-handle hex socket driver set



2059		5pc	7; 8; 10; 12; 13 mm (300mmL)		10/10.9/11.9/1.3"		1090g
-------------	--	-----	------------------------------	--	-------------------	--	-------

9pc T-handle hex socket driver set





2095		9pc	5; 6; 7; 8; 9; 10; 11; 12; 13 mm (300mmL)		6/11.3/12.3/2.4"		1880g
-------------	--	-----	---	--	------------------	--	-------

2095S		9pc	3/16"; 1/4"; 9/32"; 5/16"; 11/32"; 3/8"; 7/16"; 1/2"; 9/16" (300mmL)		6/10.5/11.5/2.4"		1750g
--------------	--	-----	--	--	------------------	--	-------



9pc T-handle star socket driver set



2096  6/10.5/11.5/2.4'  1750g
 9pc E4; E5; E6; E7; E8; E10; E12; E14; E16 (260mmL)



6pc 3-Way T-shaped hex key set



50638  20/7.6/8.6/0.6'  380g
 6pc 2; 2.5; 3; 4; 5; 6 mm



6pc 3-Way T-shaped hex key set



50639  10/10.2/11.2/0.6'  1020g
 6pc 3; 4; 5; 6; 8; 10 mm

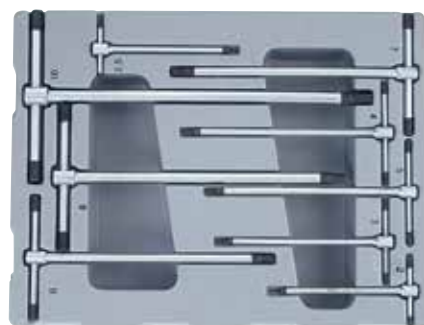

9pc 3-Way T-shaped hex key set



50912  6/8.4/9.4/1.3'  1406g
 9pc 2; 2.5; 3; 4; 5; 6; 7; 8; 10 mm



6pc Adjustable 3-way T-shaped hex key set



50638A  20/7.6/8.6/0.6'  380g
 6pc 2; 2.5; 3; 4; 5; 6 mm



6pc Adjustable 3-way T-shaped hex key set



50639A  10/10.2/11.2/0.6'  1020g
 6pc 3; 4; 5; 6; 8; 10 mm



9pc Adjustable 3-way T-shaped hex key set



50919  6/10.5/11.5/1.3'  1750g
 9pc 2; 2.5; 3; 4; 5; 6; 8; 10; 12 mm

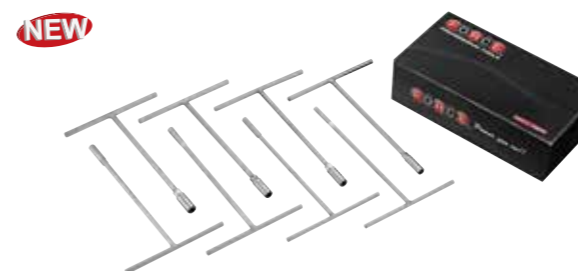

8pc T-shaped hex socket driver set

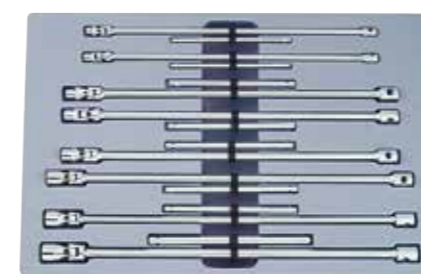

50652  10/22.0/23.0/1.3'  2264g
 8pc 6; 7; 8; 9; 10; 11; 12; 13 mm (300mmL)

8pc Long universal socket driver set



50816  6/24.2/25.2/2.8'  4030g
 8pc 1/4"DR. 7; 8 mm (400mmL)
 3/8"DR. 10; 12; 13 mm (450mmL)
 14; 17 mm (500mmL)
 1/2"DR. 19 mm (500mmL)

1/4" Phillips bit



121		<i>l</i>		
Part no.	size	mm	g	pc/bag
121250	PH.0	25	4	10
121251	PH.1	25	4	10
121252	PH.2	25	6	10
121253	PH.3	25	6	10
121300	PH.0	30	6	10
121301	PH.1	30	6	10
121302	PH.2	30	6	10
121303	PH.3	30	6	10
121304	PH.4	30	6	10
121501	PH.1	50	12	10
121502	PH.2	50	12	10
121503	PH.3	50	13	10

1/4" Double-sized phillips bit



121D		<i>l</i>		
Part no.	size	mm	g	pc/bag
121D12	PH.1xPH.2	165	40	10
121D34	PH.3xPH.4	165	42	10

1/4" Pozidriv bit



122		<i>l</i>		
Part no.	size	mm	g	pc/bag
122250	PZ.0	25	4	10
122251	PZ.1	25	4	10
122252	PZ.2	25	6	10
122253	PZ.3	25	6	10
122300	PZ.0	30	6	10
122301	PZ.1	30	6	10
122302	PZ.2	30	6	10
122303	PZ.3	30	6	10
122304	PZ.4	30	6	10
122501	PZ.1	50	12	10
122502	PZ.2	50	12	10
122503	PZ.3	50	13	10

1/4" Double-sized pozidriv bit



122D		<i>l</i>		
Part no.	size	mm	g	pc/bag
122D12	PZ.1xPZ.2	165	41	10
122D34	PZ.3xPZ.4	165	42	10

1/4" Slotted bit



123		<i>l</i>		
Part no.	size	mm	g	pc/bag
1232503	0.5x3	25	4	10
1232504	0.8x4	25	4	10
1232505	0.8x5	25	4	10
12325055	1.0x5.5	25	4	10
12325065	1.2x6.5	25	4	10
1233004	0.8x4	30	6	10
1233005	0.8x5	30	6	10
12330055	1.0x5.5	30	6	10
1233006	1.0x6	30	6	10
12330065	1.2x6.5	30	6	10
1233007	1.2x7	30	6	10
1235003	0.5X3	50	8	10
1235004	0.8X4	50	8	10
1235005	0.8X5	50	8	10
1235006	1.0X6	50	9	10
1235007	1.2X7	50	9	10

1/4" Double-sized slotted bit



123D		<i>l</i>		
Part no.	size	mm	g	pc/bag
123D0304	3mmx4mm	165	39	10
123D05507	5.5mmx7mm	165	41	10

1/4" Hex bit



124		<i>l</i>		
Part no.	size	mm	g	pc/bag
12425015	1.5	25	4	10
1242502	2	25	4	10
12425025	2.5	25	4	10
1242503	3	25	4	10
1242504	4	25	5	10
1242505	5	25	5	10
12425055	5.5	25	5	10
1242506	6	25	5	10
1242507	7	25	6	10
1242508	8	25	6	10
1242510	10	25	8	10
124251.16	1/16"	25	4	10
124253.32	3/32"	25	4	10
124251.8	1/8"	25	4	10
124255.32	5/32"	25	5	10
124253.16	3/16"	25	4	10
124257.32	7/32"	25	4	10
124251.4	1/4"	25	4	10
124259.32	9/32"	25	4	10
124255.16	5/16"	25	6	10
124253.8	3/8"	25	6	10
12430015	1.5	30	6	10
1243002	2	30	6	10
12430025	2.5	30	6	10
1243003	3	30	6	10
1243004	4	30	7	10
1243005	5	30	8	10
12430055	5.5	30	8	10
1243006	6	30	8	10
1243007	7	30	8	10
1243008	8	30	10	10
1243010	10	30	12	10
124301.8	1/8"	30	6	10
124305.32	5/32"	30	7	10
124303.16	3/16"	30	7	10
124307.32	7/32"	30	8	10
124301.4	1/4"	30	8	10
124305.16	5/16"	30	8	10
124303.8	3/8"	30	12	10

1/4" Double-sized hex bit



124D		<i>l</i>		
Part no.	size	mm	g	pc/bag
124D0304	3mmx4mm	165	40	10
124D0506	5mmx6mm	165	43	10

1/4" Hex ball point bit



125		<i>l</i>		
Part no.	size	mm	g	pc/bag
12525025	2.5	25	4	10
1252503	3	25	4	10
1252504	4	25	4	10
1252505	5	25	6	10
12525055	5.5	25	6	10
1252506	6	25	6	10
125251.8	1/8"	25	4	10
125255.32	5/32"	25	4	10
125253.16	3/16"	25	4	10
125257.32	7/32"	25	6	10
125251.4	1/4"	25	6	10
12530025	2.5	30	6	10
1253003	3	30	6	10
1253004	4	30	6	10
1253005	5	30	8	10
12530055	5.5	30	8	10
1253006	6	30	8	10
125301.8	1/8"	30	6	10
125305.32	5/32"	30	6	10
125303.16	3/16"	30	6	10
125307.32	7/32"	30	8	10
125301.4	1/4"	30	8	10

1/4" Star bit



126		<i>l</i>		
Part no.	size	mm	g	pc/bag
1262504	T4	25	4	10
1262505	T5	25	4	10
1262506	T6	25	4	10
1262507	T7	25	4	10
1262508	T8	25	4	10
1262509	T9	25	4	10
1262510	T10	25	4	10
1262515	T15	25	4	10
1262520	T20	25	4	10
1262525	T25	25	4	10
1262527	T27	25	6	10
1262530	T30	25	6	10
1262535	T35	25	6	10
1262540	T40	25	6	10
1263004	T4	30	6	10
1263005	T5	30	6	10
1263006	T6	30	6	10
1263007	T7	30	6	10
1263008	T8	30	6	10
1263009	T9	30	6	10
1263010	T10	30	6	10
1263015	T15	30	6	10
1263020	T20	30	6	10
1263025	T25	30	6	10
1263027	T27	30	8	10
1263030	T30	30	8	10
1263040	T40	30	8	10
1263045	T45	30	10	10
1263050	T50	30	10	10
1263055	T55	30	12	10
1266525	T25	65	16	10

1/4" Star tamperproof bit



127		<i>l</i>		
Part no.	size	mm	g	pc/bag
1272506	T-6H	25	4	10
1272507	T-7H	25	4	10
1272508	T-8H	25	4	10
1272509	T-9H	25	4	10
1272510	T-10H	25	4	10
1272515	T-15H	25	4	10
1272520	T-20H	25	4	10
1272525	T-25H	25	4	10
1272527	T-27H	25	6	10
1272530	T-30H	25	6	10
1272535	T-35H	25	6	10
1272540	T-40H	25	6	10
1273006	T-6H	30	6	10
1273007	T-7H	30	6	10
1273008	T-8H	30	6	10
1273009	T-9H	30	6	10
1273010	T-10H	30	6	10
1273015	T-15H	30	6	10
1273020	T-20H	30	6	10
1273025	T-25H	30	6	10
1273027	T-27H	30	8	10
1273030	T-30H	30	8	10
1273040	T-40H	30	8	10

1/4" Spline bit



128		<i>l</i>		
Part no.	size	mm	g	pc/bag
1282504	M4	25	4	10
1282505	M5	25	4	10
1282506	M6	25	6	10
1282508	M8	25	6	10
1282510	M10	25	8	10

1/4" Double-sized star bit



126D		<i>l</i>		
Part no.	size	mm	g	pc/bag
126D0810	T8xT10	165	39	10
126D1520	T15xT20	165	40	10
126D2527	T25xT27	165	41	10
126D3040	T30xT40	165	42	10

1/4" Five-sided star tamperproof bit



12F		<i>l</i>		
Part no.	size	mm	g	pc/bag
12F2508	TS8	25	4	10
12F2510	TS10	25	4	10
12F2515	TS15	25	4	10
12F2520	TS20	25	4	10
12F2525	TS25	25	4	10
12F2527	TS27	25	4	10
12F2530	TS30	25	4	10
12F2540	TS40	25	4	10
12F2545	TS45	25	6	10
12F2550	TS50	25	8	10

1/4" Torq set bit



121S		<i>l</i>		
Part no.	size	mm	g	pc/bag
121S2502 NEW	2	25	5	10
121S2504 NEW	4	25	5	10
121S2506	6	25	6	10
121S2508	8	25	6	10
121S2510	10	25	6	10
121S251.4	1/4"	25	6	10

1/4" Tri-wing bit



122S		<i>l</i>		
Part no.	size	mm	g	pc/bag
122S2501	1	25	6	10
122S2502	2	25	6	10
122S2503	3	25	6	10
122S2504	4	25	6	10

1/4" Spanner bit



123S		<i>l</i>		
Part no.	size	mm	g	pc/bag
123S2504	4	25	6	10
123S2506	6	25	6	10
123S2508	8	25	6	10
123S2510	10	25	6	10
123S2512 NEW	12	25	6	10
123S2514 NEW	14	25	6	10

1/4" Hex security bit



124S		<i>l</i>		
Part no.	size	mm	g	pc/bag
124S2502	2	25	6	10
124S25025	2.5	25	6	10
124S2503	3	25	6	10
124S2504	4	25	6	10
124S2505	5	25	6	10
124S2506	6	25	6	10
124S255.64	5/64"	25	6	10
124S253.32	3/32"	25	6	10
124S257.64	7/64"	25	6	10
124S251.8	1/8"	25	6	10
124S259.64	9/64"	25	6	10
124S255.32	5/32"	25	6	10

1/4" Square bit



124R		<i>l</i>		
Part no.	size	mm	g	pc/bag
124R250	0	25	6	10
124R251	1	25	6	10
124R252	2	25	6	10
124R253	3	25	6	10
124R500	0	50	12	10
124R501	1	50	12	10
124R502	2	50	12	10

5/16" Pozidriv bit



152		<i>l</i>		
Part no.	size	mm	g	pc/bag
152301	PZ.1	30	10	10
152302	PZ.2	30	10	10
152303	PZ.3	30	10	10
152304	PZ.4	30	10	10
152321	PZ.1	32	10	10
152322	PZ.2	32	10	10
152323	PZ.3	32	12	10
152362	PZ.2	36	13	10
152363	PZ.3	36	13	10
152384	PZ.4	38	14	10
152802	PZ.2	80	30	10
152803	PZ.3	80	31	10

5/16" Hex bit



154		<i>l</i>		
Part no.	size	mm	g	pc/bag
1543003	3	30	8	10
1543004	4	30	9	10
1543005	5	30	10	10
1543006	6	30	11	10
1543007	7	30	12	10
1543008	8	30	12	10
1543010	10	30	16	10
1543012	12	30	21	10
1543014	14	30	25	10
154301.8	1/8"	30	12	10
154305.32	5/32"	30	12	10
154303.16	3/16"	30	12	10
154307.32 <small>NEW</small>	7/32"	30	12	10
154301.4	1/4"	30	12	10
154309.32	9/32"	30	13	10
154305.16	5/16"	30	13	10
154303.8	3/8"	30	16	10
154307.16	7/16"	30	18	10
154301.2	1/2"	30	22	10
154309.16	9/16"	30	26	10
1543606	6	36	13	10
1543608	8	36	14	10
1543610	10	36	16	10
1547004	4	70	50	10
1547005	5	70	50	10
1547006	6	70	50	10
1547007	7	70	52	10
1547008	8	70	53	10
1547010	10	70	55	10
1547012	12	70	55	10
1547014	14	70	60	10

5/16" Star bit



156		<i>l</i>		
Part no.	size	mm	g	pc/bag
1563010	T10	30	9	10
1563015	T15	30	9	10
1563020	T20	30	9	10
1563025	T25	30	9	10
1563027	T27	30	9	10
1563030	T30	30	10	10
1563040	T40	30	10	10
1563045	T45	30	11	10
1563050	T50	30	12	10
1563055	T55	30	14	10
1563060	T60	30	24	10
1563520	T20	35	12	10
1563525	T25	35	12	10
1563527	T27	35	12	10
1563530	T30	35	12	10
1563540	T40	35	12	10
1563545	T45	35	12	10
1563550	T50	35	14	10
1563555	T55	35	16	10
1567010	T10	70	30	10
1567015	T15	70	30	10
1567020	T20	70	30	10
1567025	T25	70	30	10
1567027	T27	70	30	10
1567030	T30	70	30	10
1567040	T40	70	30	10
1567045	T45	70	30	10
1567050	T50	70	30	10
1567055	T55	70	40	10
1567060	T60	70	56	10

5/16" Phillips bit



151		<i>l</i>		
Part no.	size	mm	g	pc/bag
151301	PH.1	30	10	10
151302	PH.2	30	10	10
151303	PH.3	30	10	10
151304	PH.4	30	11	10
151321	PH.1	32	10	10
151322	PH.2	32	10	10
151323	PH.3	32	12	10
151361	PH.1	36	13	10
151362	PH.2	36	13	10
151363	PH.3	36	13	10
151384	PH.4	38	14	10
151802	PH.2	80	30	10
151803	PH.3	80	31	10

5/16" Slotted bit



153		<i>l</i>		
Part no.	size	mm	g	pc/bag
15330055	0.8x5.5	30	9	10
1533007	1.2x7	30	10	10
1533008	1.2x8	30	12	10
1533010	1.6x10	30	14	10
1533012	2.0x12	30	14	10
1533609	1.6x9	36	16	10
1533610	1.6x10	36	16	10
1533611	1.8x11	36	16	10
1533612	2.0x12	36	16	10
1538009	1.6x9	80	32	10
1538011	1.8x11	80	33	10

5/16" Star tamperproof bit



157		<i>l</i>		
Part no.	size	mm	g	pc/bag
1573010	T-10H	30	10	10
1573015	T-15H	30	10	10
1573020	T-20H	30	10	10
1573025	T-25H	30	10	10
1573027	T-27H	30	10	10
1573030	T-30H	30	10	10
1573040	T-40H	30	10	10
1573045	T-45H	30	10	10
1573050	T-50H	30	12	10
1573055	T-55H	30	14	10
1573060	T-60H	30	24	10
1577010	T-10H	70	30	10
1577015	T-15H	70	30	10
1577020	T-20H	70	30	10
1577025	T-25H	70	30	10
1577027	T-27H	70	30	10
1577030	T-30H	70	30	10
1577040	T-40H	70	30	10
1577045	T-45H	70	30	10
1577050	T-50H	70	30	10
1577055	T-55H	70	40	10
1577060	T-60H	70	56	10

10mm Hex bit



174		<i>l</i>		
Part no.	size	mm	g	pc/bag
1743004	4	30	13	10
1743005	5	30	14	10
1743006	6	30	14	10
1743007	7	30	16	10
1743008	8	30	17	10
1743009	9	30	18	10
1743010	10	30	20	10
1743012	12	30	25	10
1743014	14	30	27	10
1747504	4	75	43	10
1747505	5	75	43	10
1747506	6	75	44	10
1747507	7	75	45	10
1747508	8	75	47	10
1747509	9	75	48	10
1747510	10	75	50	10
1747512	12	75	67	10
17412008	8	120	80	10
17412010	10	120	82	10

10mm Square bit



174S		<i>l</i>		
Part no.	size	mm	g	pc/bag
174S3008	8	30	17	10
174S3009	9	30	19	10
174S3010	10	30	20	10
174S3013	13	30	26	10

10mm Star bit



176		<i>l</i>		
Part no.	size	mm	g	pc/bag
1763010	T10	30	12	10
1763015	T15	30	12	10
1763020	T20	30	13	10
1763025	T25	30	13	10
1763027	T27	30	14	10
1763030	T30	30	14	10
1763035	T35	30	14	10
1763040	T40	30	15	10
1763045	T45	30	16	10
1763047	T47	30	20	10
1763050	T50	30	16	10
1763055	T55	30	18	10
1763060	T60	30	22	10
1767510	T10	75	41	10
1767515	T15	75	41	10
1767520	T20	75	42	10
1767525	T25	75	42	10
1767527	T27	75	42	10
1767530	T30	75	43	10
1767535	T35	75	44	10
1767540	T40	75	44	10
1767545	T45	75	45	10
1767550	T50	75	45	10
1767555	T55	75	48	10
1767560	T60	75	64	10
1767570 <small>NEW</small>	T70	75	64	10
17611555	T55	115	70	10
17612040	T40	120	72	10
17612045	T45	120	72	10
17612050	T50	120	74	10
17612055	T55	120	74	10

10mm Star tamperproof bit



177		<i>l</i>		
Part no.	size	mm	g	pc/bag
1773010	T-10H	30	14	10
1773015	T-15H	30	14	10
1773020	T-20H	30	14	10
1773025	T-25H	30	14	10
1773027	T-27H	30	14	10
1773030	T-30H	30	14	10
1773040	T-40H	30	14	10
1773045	T-45H	30	16	10
1773050	T-50H	30	16	10
1773055	T-55H	30	18	10
1773060	T-60H	30	22	10
1777510	T-10H	75	42	10
1777515	T-15H	75	42	10
1777520	T-20H	75	42	10
1777525	T-25H	75	42	10
1777527	T-27H	75	42	10
1777530	T-30H	75	42	10
1777540	T-40H	75	44	10
1777545	T-45H	75	44	10
1777550	T-50H	75	46	10
1777555	T-55H	75	48	10
1777560	T-60H	75	66	10

10mm Spline bit



178		<i>l</i>		
Part no.	size	mm	g	pc/bag
1783005	M5	30	13	10
1783006	M6	30	14	10
1783007	M7	30	14	10
1783008	M8	30	15	10
1783009	M9	30	16	10
1783010	M10	30	17	10
1783012	M12	30	20	10
1783014	M14	30	25	10
1787504	M4	75	43	10
1787505	M5	75	43	10
1787506	M6	75	43	10
1787507	M7	75	43	10
1787508	M8	75	44	10
1787509	M9	75	46	10
1787510	M10	75	47	10
1787512	M12	75	58	10
1787514	M14	75	80	10
1787516 NEW	M16	75	80	10
17812008	M8	120	74	10
17812010	M10	120	77	10
17812012	M12	120	106	10

10mm Ribe bit



179		<i>l</i>		
Part no.	size	mm	g	pc/bag
1793004	M4	30	14	10
1793005	M5	30	14	10
1793006	M6	30	14	10
1793007	M7	30	14	10
1793008	M8	30	14	10
1793009	M9	30	18	10
1793010 NEW	M10	30	19	10
1793012	M12	30	20	10
1793013	M13	30	22	10
1793014	M14	30	24	10
1797504	M4	75	42	10
1797505	M5	75	42	10
1797506	M6	75	42	10
1797507	M7	75	42	10
1797508	M8	75	44	10
1797509	M9	75	46	10
1797510	M10	75	47	10
1797512	M12	75	63	10
1797513	M13	75	78	10
1797514	M14	75	79	10

14mm Star bit



196		<i>l</i>		
Part no.	size	mm	g	pc/bag
1965060	T60	50	56	10
1965070	T70	50	60	10
1967560	T60	75	88	10
1967570	T70	75	93	10

1/4" Adapter



80922		<i>l</i>		
Part no.	size	mm	g	pc/box
80922	1/4" Inhex - 1/4"Sq.	26	18	25

1/4" Adapter



8092		<i>l</i>		
Part no.	size	mm	g	pc/box
8092225	1/4"Hex-1/4"Sq.	25	8	10
8092230	1/4"Hex-1/4"Sq.	30	10	10
8092250	1/4"Hex-1/4"Sq.	50	16	50

5/16" Adapter



8095		<i>l</i>		
Part no.	size	mm	g	pc/box
8095330	5/16"Hex-3/8"Sq.	30	16	20
8095430	5/16"Hex-1/2"Sq.	30	30	10

1/4" Extension adapter



80922175		<i>l</i>		
Part no.	size	mm	g	pc/box
80922175	1/4"Hex-1/4"Sq.	175	73	20

1/4" Flexible bit holder extension



8112		<i>l</i>		
Part no.	size	mm	g	pc/box
8112	1/4"Hex-1/4"Inhex	175	73	10

1/4" Magnetic bit holder extension



812		<i>l</i>		
Part no.	size	mm	g	pc/box
81260	1/4"Hex-1/4"Inhex	60	23	50
812175	1/4"Hex-1/4"Inhex	175	55	20

1/4" Magnetic QR bit holder



81260Q		<i>l</i>		
Part no.	size	mm	g	pc/box
81260Q	1/4"Hex-1/4"Hex	60	32	10

1/4" Magnetic QR bit holder



81280Q		<i>l</i>		
Part no.	size	mm	g	pc/box
81280Q	1/4"Hex-1/4"Hex	75	38	10

- 81280Q with a second magnet to keep screws always straight and centered

1/4" Mini ratchet bit handle



802214	<i>l</i>		
Part no.	mm	g	pc/box
802214	130	120	10

1/4" Magnetic bit spinner



8144		<i>l</i>		
Part no.	size	mm	g	pc/box
8144	1/4"hex	215	117	10

1/4" Quick-release bit spinner



8148		<i>l</i>		
Part no.	size	mm	g	pc/box
8148	1/4"hex	150-6"	105	10

1/4" Bit driver handle

NEW



8152		<i>l</i>		
Part no.	size	mm	g	pc/box
8152	1/4" hex	125	70	1

Assembly:



1/4" Ratchet bit spinner handle



8152R		<i>l</i>		
Part no.	size	mm	g	pc/box
8152R	1/4" hex	200	170	1

Assembly:

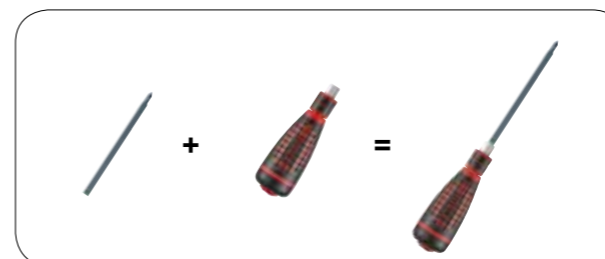

Phillips screwdriver



711		<i>l</i>	<i>l</i>		
Part no.	Tip	blade	over	g	pc/box
7111S	PH.1	25	75	39	10
7112S	PH.2	25	75	42	10
7110	PH.0	60	145	33	10
7111	PH.1	80	185	79	10
7112	PH.2	10	215	11	10
7113	PH.3	150	275	226	10
7111502 NEW	PH.2	150	265	109	10
7112002 NEW	PH.2	200	315	121	10

Pozidriv screwdriver



712		<i>l</i>	<i>l</i>		
Part no.	Tip	blade	over	g	pc/box
7121S	PZ.1	25	75	38	10
7122S	PZ.2	25	75	42	10
7120	PZ.0	60	145	32	10
7121	PZ.1	80	185	79	10
7122	PZ.2	100	215	114	10
7123	PZ.3	150	278	197	10

Slotted screwdriver



713		<i>l</i>	<i>l</i>		
Part no.	Tip	blade	over	g	pc/box
713055S	1.0 x 5.5	25	75	36	10
713065S	1.2 x 6.5	25	75	40	10
71303	0.5 x 3	75	160	31	10
713035	0.5 x 3.5	100	185	35	10
71304	0.8 x 4	100	205	58	10
713055	1.0 x 5.5	125	230	65	10
713065	1.2 x 6.5	150	265	132	10
71308	1.2x8	175	300	206	10
713100065 NEW	1.2x6.5	100	215	76	10
713200065 NEW	1.2x6.5	200	315	121	10

Hammer phillips screwdriver



711...M		<i>l</i>	<i>L</i>		
Part no.	Tip	blade	over	g	pc/box
7111M	PH.1	80	185	96	10
7112M	PH.2	100	215	138	10
7113M	PH.3	150	275	231	10
7114M	PH.4	200	325	329	10
7113004M	PH.4	300	425	205	5

Hammer slotted screwdriver



713...M		<i>l</i>	<i>L</i>		
Part no.	Tip	blade	over	g	pc/box
713055M	5.5	125	230	103	10
713065M	6.5	150	265	154	10
71308M	8	150	275	232	10
71310M	10	200	325	327	10
71312M	12	200	325	329	10
71314M	14	250	375	364	10
71330010M NEW	10	300	425	294	5

Hex ball point screwdriver



715		<i>l</i>	<i>L</i>		
Part no.	Tip	blade	over	g	pc/box
71502	2	100	185	27	10
715025	2.5	100	185	29	10
71503	3	100	185	32	10
71504	4	100	205	66	10
71505	5	100	205	76	10
71506	6	125	240	109	10
71508	8	150	275	187	10
71510	10	150	275	221	10

Extra-long star screwdriver



716300		<i>l</i>	<i>L</i>		
Part no.	Tip	blade	over	g	pc/box
71630010	T10	300	405	86	10
71630015	T15	300	405	86	10
71630020	T20	300	405	105	10
71630025	T25	300	405	144	10
70630027	T27	300	415	144	10
70630030	T30	300	415	144	10
71630040	T40	300	415	263	10
71630045	T45	300	427	264	5

Hammer pozidriv screwdriver

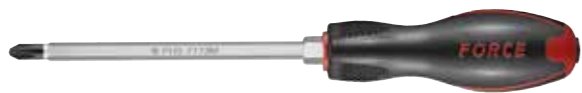

712...M		<i>l</i>	<i>L</i>		
Part no.	Tip	blade	over	g	pc/box
7121M	PZ.1	80	185	88	10
7122M	PZ.2	100	215	138	10
7123M	PZ.3	150	275	231	10
7124M	PZ.4	200	325	316	10
7123004M	PZ.4	300	425	380	5

Hex screwdriver



714		<i>l</i>	<i>L</i>		
Part no.	Tip	blade	over	g	pc/box
71402	2	100	160	31	10
714025	2.5	100	160	33	10
71403	3	100	160	36	10
71404	4	100	180	66	10
71405	5	100	180	76	10
71406	6	125	215	109	10
71408	8	150	225	174	10
71410	10	150	225	222	10

Star screwdriver



716		<i>l</i>	<i>L</i>		
Part no.	Tip	blade	over	g	pc/box
71605	T5	60	145	32	10
71606	T6	60	145	32	10
71607	T7	60	145	32	10
71608	T8	60	145	32	10
71609	T9	60	145	32	10
71610	T10	80	185	34	10
71615	T15	80	185	35	10
71620	T20	100	205	65	10
71625	T25	100	205	73	10
71627	T27	115	230	106	10
71630	T30	115	230	107	10
71640	T40	130	245	153	10
71645	T45	130	255	166	10
71618506	T6	100	185	38	10
71618507	T7	100	185	38	10
71618508	T8	100	185	38	10
71618509	T9	100	185	38	10

Star tamperproof screwdriver



717		<i>l</i>	<i>L</i>		
Part no.	Tip	blade	over	g	pc/box
71705	T-5H	60	145	31	10
71706	T-6H	60	145	31	10
71707	T-7H	60	145	33	10
71708	T-8H	60	145	33	10
71709	T-9H	60	145	32	10
71710	T-10H	80	185	62	10
71715	T-15H	80	185	62	10
71720	T-20H	100	205	64	10
71725	T-25H	100	205	73	10
71727	T-27H	115	230	106	10
71730	T-30H	115	230	107	10
71740	T-40H	130	245	151	10
71745	T-45H	130	255	168	10

Five-sided star tamperproof screwdriver



71F		<i>l</i>	<i>L</i>		
Part no.	Tip	blade	over	g	pc/box
71F10	TS10	150	255	62	10
71F15	TS15	150	255	62	10
71F20	TS20	150	255	62	10
71F25	TS25	150	255	73	10
71F27	TS27	150	270	104	10
71F30	TS30	150	270	104	10
71F40	TS40	150	280	146	10

Adjustment phillips screwdriver



6551		<i>l</i>	<i>L</i>		
Part no.	size	blade	over	g	pc/box
65511	PH.1	350	450	75	10
65512	PH.2	350	450	75	5

Adjustment slotted screwdriver



6553		<i>l</i>	<i>L</i>		
Part no.	size	blade	over	g	pc/box
655304	4	300	400	65	10
655305	5	300	400	65	10
655306	6	300	400	65	10
655308	8	300	400	70	5

Flexible hex socket driver



648		<i>l</i>	<i>L</i>		
Part no.	size	blade	over	g	pc/ctn
648055	5.5	160	270	190	60
64806	6	160	270	192	60
64807	7	160	270	196	60
64808	8	160	270	198	60
6481.4	1/4"	160	270	192	60
6485.16	5/16"	160	270	198	60

Hex socket driver



744		<i>l</i>	<i>L</i>		
Part no.	Tip	blade	over	g	pc/box
74425004	4	135	250	126	10
744250045	4.5	135	250	126	10
74425005	5	135	250	131	10
744250055	5.5	135	250	136	10
74425006	6	135	250	141	10
74425007	7	135	250	144	10
74425008	8	135	250	147	10
74425009	9	135	250	153	10
74425010	10	135	250	188	10
74425011	11	135	250	194	10
74425012	12	135	250	194	10
74425013	13	135	250	207	10
74425014	14	135	250	234	10
7442503.16	3/16"	135	250	126	10
7442501.4	1/4"	135	250	141	10
7442505.16	5/16"	135	250	147	10
7442503.8	3/8"	135	250	188	10
7442507.16	7/16"	135	250	194	10
7442501.2	1/2"	135	250	207	10
7442509.16	9/16"	135	250	234	10

Adjustment phillips screwdriver



65512L		<i>l</i>	<i>L</i>		
Part no.	size	blade	over	g	pc/box
65512L	PH.2	400	515	215	10

Adjustment slotted screwdriver



6553065L		<i>l</i>	<i>L</i>		
Part no.	size	blade	over	g	pc/box
6553065L	6.5	400	515	215	10

Flexible hex socket driver



6480607		<i>l</i>	<i>L</i>		
Part no.	size	blade	over	g	pc/ctn
6480607	6x7	190	290	220	60

Adjustment pozidriv screwdriver



65522L		<i>l</i>	<i>L</i>		
Part no.	size	blade	over	g	pc/box
65522L	PZ.2	400	515	215	10

Spline screwdriver M4



71817004A		blade		
Part no.	M4	80mm	35g	10pc

- For removing & fitting the internal covering of tail lamps and dashboards as fitted to the Golf IV & new AUDI / VW models.
- For door handle VW passat and Golf IV.

Flexible hex socket driver



648...L		<i>l</i>	<i>L</i>		
Part no.	size	blade	over	g	pc/box
648055L	5.5	500	630	275	10
64806L	6	500	630	275	10
64807L	7	500	630	275	10
64808L	8	500	630	275	10

Insulated phillips screwdriver

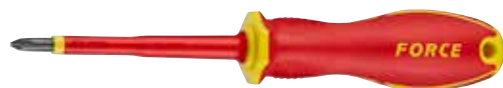

711N		<i>l</i>	<i>L</i>		
Part no.	Tip	blade	over	g	pc/box
711N0	PH.0	60	145	32	10
711N1	PH.1	80	190	67	10
711N2	PH.2	100	220	100	10
711N3	PH.3	150	280	186	10

Insulated slotted screwdriver



713N		<i>l</i>	<i>L</i>		
Part no.	Tip	blade	over	g	pc/box
713N025	2.5	75	160	31	10
713N03	3	100	185	35	10
713N035	3.5	100	185	38	10
713N04	4	100	210	67	10
713N055	5.5	125	235	85	10
713N065	6.5	150	270	121	10
713N08	8	175	305	196	10

Phillips jeweler screwdriver

NEW



731A		<i>l</i>	<i>L</i>		
Part no.	Tip	blade	over	g	pc/box
731A040000	PH.000	40	130	12	10
731A04000	PH.00	40	130	13	10
731A0400	PH.0	40	130	14	10
731A075000	PH.000	75	165	14	10
731A07500	PH.00	75	165	14	10
731A0750	PH.0	75	165	16	10
731A0751	PH.1	75	165	20	10

Star jeweler screwdriver

NEW



736A		<i>l</i>	<i>L</i>		
Part no.	Tip	blade	over	g	pc/box
736A04005	T5	40	130	13	10
736A04006	T6	40	130	13	10
736A04007	T7	40	130	14	10
736A04008	T8	40	130	14	10
736A07509	T9	75	165	17	10
736A07510	T10	75	165	17	10
736A07515	T15	75	165	18	10
736A07520	T20	75	165	20	10

Insulated pozidriv screwdriver



712N		<i>l</i>	<i>L</i>		
Part no.	Tip	blade	over	g	pc/box
712N0	PZ.0	60	145	32	10
712N1	PZ.1	80	190	67	10
712N2	PZ.2	100	220	99	10
712N3	PZ.3	150	280	183	10

Insulated hex socket driver

NEW



744N		<i>l</i>	<i>L</i>		
Part no.	Tip	blade	over	g	pc/box
744N05	5	125	245	122	10
744N06	6	125	245	124	10
744N07	7	125	245	130	10
744N08	8	125	245	133	10
744N09	9	125	245	135	10
744N10	10	125	245	138	10
744N11	11	125	245	160	10
744N12	12	125	245	163	10
744N13	13	125	245	168	10

Slotted jeweler screwdriver

NEW



733A		<i>l</i>	<i>L</i>		
Part no.	Tip	blade	over	g	pc/box
733A040008	0.8	40	130	12	10
733A04001	1.0	40	130	12	10
733A040012	1.2	40	130	12	10
733A040015	1.5	40	130	12	10
733A040018	1.8	40	130	12	10
733A04002	2.0	40	130	12	10
733A040025	2.5	40	130	13	10
733A07502	2.0	75	165	14	10
733A075025	2.5	75	165	14	10
733A07503	3.0	75	165	16	10
733A075035	3.5	75	165	18	10
733A07504	4.0	75	165	20	10

Star tamperproof jeweler screwdriver

NEW



737A		<i>l</i>	<i>L</i>		
Part no.	Tip	blade	over	g	pc/box
737A04005	T-5H	40	130	13	10
737A04006	T-6H	40	130	13	10
737A04007	T-7H	40	130	14	10
737A04008	T-8H	40	130	14	10
737A07509	T-9H	75	165	17	10
737A07510	T-10H	75	165	17	10
737A07515	T-15H	75	165	18	10
737A07520	T-20H	75	165	20	10

Hex key



764	Tip	short	long	g	pc/bag
7640127	1.27	13	41	2	10
764015	1.5	15	46	2	10
76402	2	18	52	2	10
764025	2.5	20	58	4	10
76403	3	23	66	5	10
764035	3.5	25	69	7	10
76404	4	29	74	10	10
764045	4.5	30	80	14	10
76405	5	33	85	20	10
764055	5.5	35	90	24	10
76406	6	38	96	30	10
76407	7	41	102	44	10
76408	8	44	108	60	10
76409	9	47	114	78	10
76410	10	50	122	105	10
76411	11	53	129	131	5
76412	12	57	137	167	5
76413	13	63	145	209	5
76414	14	70	154	258	5
76415 <small>NEW</small>	15	73	161	315	5
76416	16	76	166	367	5
76417	17	80	177	441	5
76418 <small>NEW</small>	18	84	188	524	5
76419	19	89	199	620	5
76421	21	96	211	804	5
76422	22	102	222	927	5
76423	23	108	233	1064	5
76424	24	114	248	1235	5
76426	26	123	265	1566	5
76427	27	127	277	1770	5
76430	30	142	315	2410	5
76432	32	157	347	3100	5
76436	36	176	391	4370	4
7641.16	1/16"	15	46	1	10
7645.64	5/64"	18	52	2	10
7643.32	3/32"	20	58	3	10
7647.64	7/64"	22	62	4	10
7641.8	1/8"	23	66	6	10
7649.64	9/64"	25	69	8	10
7645.32	5/32"	29	74	10	10
7643.16	3/16"	33	85	17	10
7647.32	7/32"	35	90	24	10
7641.4	1/4"	38	96	34	10
7649.32	9/32"	41	102	43	10
7645.16	5/16"	44	108	59	10
7643.8	3/8"	50	122	97	10
7647.16	7/16"	56	136	141	10
7641.2	1/2"	58	145	194	5
7649.16	9/16"	70	154	268	5
7645.8	5/8"	79	176	383	5
7643.4	3/4"	89	199	621	5
7647.8	7/8"	102	222	950	5
7641.0	1"	115	250	1386	5

Long hex key



764...L	Tip	short	long	g	pc/bag
7640127L	1.27	13	69	2	10
764015L	1.5	15	78	2	10
76402L	2	18	85	3	10
764025L	2.5	20	92	5	10
76403L	3	23	101	7	10
764035L	3.5	25	105	10	10
76404L	4	29	110	14	10
764045L	4.5	30	116	20	10
76405L	5	33	123	25	10
764055L	5.5	35	133	34	10
76406L	6	38	144	41	10
76407L	7	41	154	60	10
76408L	8	44	195	84	10
76409L	9	47	169	114	10
76410L	10	50	180	144	10
76411L	11	53	201	188	5
76412L	12	57	217	244	5
76413L	13	63	228	301	5
76414L	14	70	244	374	5
76417L	17	80	267	614	5
76419L	19	89	299	862	5
76422L <small>NEW</small>	22	102	352	1389	5
7641.16L	1/16"	15	78	2	10
7645.64L	5/64"	18	85	3	10
7643.32L	3/32"	20	92	5	10
7641.8L	1/8"	23	101	8	10
7645.32L	5/32"	29	110	14	10
7643.16L	3/16"	33	123	25	10
7647.32L	7/32"	35	133	34	10
7641.4L	1/4"	38	143	46	10
7649.32L	9/32"	41	154	58	10
7645.16L	5/16"	44	164	81	10
7643.8L	3/8"	50	180	129	10
7641.2L	1/2"	58	220	252	5
7649.16L	9/16"	70	244	388	5
7645.8L	5/8"	79	266	532	5
7643.4L	3/4"	89	299	900	5
7647.8L	7/8"	102	352	1386	5

Extra long hex key



764...XL	Tip	short	long	g	pc/bag
7640127XL	1.27	13	81	2	10
764015XL	1.5	15	91	2	10
76402XL	2	18	102	3	10
764025XL	2.5	20	114	6	10
76403XL	3	23	129	9	10
764035XL	3.5	25	135	13	10
76404XL	4	29	144	18	10
764045XL	4.5	30	154	24	10
76405XL	5	33	165	33	10
764055XL	5.5	35	175	41	10
76406XL	6	38	186	53	10
76407XL	7	41	197	75	10
76408XL	8	44	208	103	10
76409XL	9	47	219	137	10
76410XL	10	50	234	180	10
76411XL	11	53	251	230	10
76412XL	12	57	262	288	5
76413XL	13	63	273	356	5
76414XL	14	70	294	445	5
76416XL	16	76	316	627	5
76417XL	17	80	337	751	5
76419XL	19	89	379	1038	5
7641.16XL	1/16"	15	91	2	10
7645.64XL	5/64"	18	102	3	10
7643.32XL	3/32"	20	114	5	10
7647.64XL	7/64"	22	122	8	10
7641.8XL	1/8"	23	129	10	10
7649.64XL	9/64"	25	135	14	10
7645.32XL	5/32"	29	144	18	10
7643.16XL	3/16"	33	165	29	10
7647.32XL	7/32"	35	175	41	10
7641.4XL	1/4"	38	186	57	10
7649.32XL <small>NEW</small>	9/32"	41	197	77	10
7645.16XL	5/16"	44	208	99	10
7643.8XL	3/8"	50	234	162	10
7647.16XL	7/16"	56	247	234	10
7641.2XL	1/2"	58	263	321	5
7649.16XL	9/16"	70	294	464	5
7645.8XL	5/8"	79	336	656	5
7643.4XL	3/4"	89	379	1057	5

Long hex ball point key



765...L	Tip	short	long	g	pc/bag
7650127L	1.27	13	69	2	10
765015L	1.5	15	78	2	10
76502L	2	18	85	3	10
765025L	2.5	20	92	5	10
76503L	3	23	101	7	10
765035L	3.5	25	105	10	10
76504L	4	29	110	14	10
76505L	5	33	123	24	10
76506L	6	38	144	40	10
76507L	7	41	154	59	10
76508L	8	44	164	81	10
76510L	10	50	180	139	10
76512L	12	57	217	240	5
76514L	14	70	244	374	5
7651.16L	1/16"	15	78	2	10
7655.64L	5/64"	18	85	3	10
7653.32L	3/32"	20	92	5	10
7651.8L	1/8"	23	101	8	10
7655.32L	5/32"	29	110	13	10
7653.16L	3/16"	33	123	22	10
7657.32L	7/32"	35	133	34	10
7651.4L	1/4"	38	143	45	10
7655.16L	5/16"	44	164	80	10
7653.8L	3/8"	50	180	127	10
7651.2L	1/2"	58	220	272	5
7659.16L	9/16"	70	244	388	5

Extra long hex ball point key



765...XL					
Part no.	Tip	short	long	g	pc/bag
7650127XL	1.27	13	81	2	10
765015XL	1.5	15	91	2	10
76502XL	2	18	102	3	10
765025XL	2.5	20	114	6	10
76503XL	3	23	129	9	10
76504XL	4	29	144	17	10
76505XL	5	33	165	31	10
76506XL	6	38	186	50	10
76507XL	7	41	197	75	10
76508XL	8	44	208	101	10
76510XL	10	50	234	176	10
76512XL	12	57	262	284	5
76514XL	14	70	294	439	5
76517XL	17	80	337	748	5
76519XL	19	89	379	1038	5
7651.16XL	1/16"	15	91	2	10
7655.64XL	5/64"	18	102	2	10
7653.32XL	3/32"	20	114	5	10
7651.8XL	1/8"	23	129	10	10
7655.32XL	5/32"	29	144	17	10
7653.16XL	3/16"	33	165	28	10
7651.4XL	1/4"	38	186	57	10
7655.16XL	5/16"	44	208	99	10
7653.8XL	3/8"	50	234	160	10
7651.2XL	1/2"	58	263	294	10

Star key



766					
Part no.	Tip	short	long	g	pc/bag
76606	T6	20	42	3	10
76607	T7	20	43	3	10
76608	T8	20	45	3	10
76609	T9	20	45	3	10
76610	T10	20	47	3	10
76615	T15	23	53	7	10
76620	T20	23	60	8	10
76625	T25	26	60	11	10
76627	T27	29	66	13	10
76630	T30	32	75	20	10
76640	T40	34	82	30	10
76645	T45	40	89	43	10
76647	T47	40	100	58	10
76650	T50	40	97	58	10
76655	T55	50	107	107	10
76660	T60	55	126	178	5
76670	T70	63	140	261	5
76680	T80	78	150	373	5

Long star key



766...L					
Part no.	Tip	short	long	g	pc/bag
76606L	T6	21	67	4	10
76607L	T7	21	72	5	10
76608L	T8	21	76	5	10
76609L	T9	21	79	5	10
76610L	T10	24	85	6	10
76615L	T15	28	88	10	10
76620L	T20	29	94	11	10
76625L	T25	32	98	18	10
76627L	T27	33	104	19	10
76630L	T30	32	118	30	10
76635L	T35	38	126	40	10
76640L	T40	38	126	44	10
76645L	T45	40	138	62	10
76650L	T50	42	160	90	10
76655L	T55	51	178	166	10
76660L	T60	57	197	266	5

Extra long star key

NEW



766...XL					
Part no.	Tip	short	long	g	pc/bag
76610XL	T10	20	92	5	10
76615XL	T15	23	103	12	10
76620XL	T20	23	115	12	10
76625XL	T25	26	130	23	10
76627XL	T27	29	145	27	10
76630XL	T30	32	166	41	10
76640XL	T40	34	186	60	10
76645XL	T45	40	208	94	10
76650XL	T50	40	233	112	10

Long star & star ball point key



766...BL					
Part no.	Tip	short	long	g	pc/bag
76610BL	8	17	72	5	10
76615BL	10	17	82	10	10
76620BL	11	18	91	11	10
76625BL	12	18	95	18	10
76627BL	13	20	103	19	10
76630BL	14	24	113	31	10
76640BL	17	26	132	48	10
76645BL	19	30	134	65	10
76650BL	22	32	136	84	10

Star tamperproof key



767					
Part no.	Tip	short	long	g	pc/bag
76706	T-6H	21	42	3	10
76707	T-7H	21	43	3	10
76708	T-8H	23	45	3	10
76709	T-9H	23	45	3	10
76710	T-10H	24	46	4	10
76715	T-15H	28	52	6	10
76720	T-20H	29	60	7	10
76725	T-25H	32	60	11	10
76727	T-27H	33	60	12	10
76730	T-30H	32	75	19	10
76740	T-40H	38	83	29	10
76745	T-45H	40	89	42	10
76747	T-47H	38	100	58	10
76750	T-50H	42	97	57	10
76755	T-55H	51	107	105	10
76760	T-60H	57	126	175	5

Long star tamperproof key



767...L					
Part no.	Tip	short	long	g	pc/bag
76706L	T-6H	21	68	4	10
76707L	T-7H	21	73	5	10
76708L	T-8H	23	76	5	10
76709L	T-9H	23	79	6	10
76710L	T-10H	24	85	6	10
76715L	T-15H	28	88	8	10
76720L	T-20H	29	94	11	10
76725L	T-25H	32	98	18	10
76727L	T-27H	33	104	19	10
76730L	T-30H	32	118	29	10
76735L	T-35H	38	126	37	10
76740L	T-40H	38	126	44	10
76745L	T-45H	40	138	61	10
76750L	T-50H	42	160	88	10
76755L	T-55H	51	178	164	10
76760L	T-60H	57	197	267	5

Extra long star tamperproof key

NEW



767...XL		<i>l</i>	<i>l</i>		
Part no.	Tip	short	long	g	pc/bag
76710XL	T-10H	20	92	5	10
76715XL	T-15H	23	103	12	10
76720XL	T-20H	23	115	12	10
76725XL	T-25H	26	130	23	10
76727XL	T-27H	29	145	27	10
76730XL	T-30H	32	166	41	10
76740XL	T-40H	34	186	60	10
76745XL	T-45H	40	208	94	10
76750XL	T-50H	40	233	112	10

Five-sided star tamperproof key



76F		<i>l</i>	<i>l</i>		
Part no.	Tip	short	long	g	pc/bag
76F10	TS10	20	46	4	10
76F15	TS15	23	52	6	10
76F20	TS20	23	60	8	10
76F25	TS25	26	61	11	10
76F27	TS27	28	67	13	10
76F30	TS30	30	74	20	10
76F40	TS40	34	82	30	10
76F45	TS45	40	89	43	10
76F50	TS50	40	98	58	10

Star & star tamperproof grip key



767...G			<i>l</i>	<i>l</i>		
Part no.	Tip	short	long	g	pc/box	
76710G	T10xT-10H	53	126	27	10	
76715G	T15xT-15H	53	126	27	10	
76720G	T20xT-20H	68	126	27	10	
76725G	T25xT-25H	68	133	84	10	
76727G	T27xT-27H	68	133	84	10	
76730G	T30xT-30H	82	190	85	10	
76740G	T40xT-40H	82	190	144	10	
76745G	T45xT-45H	82	190	144	10	
76750G	T50xT-50H	82	190	334	10	
76755G	T55xT-55H	82	190	340	10	

T-handle hex ball point key



725		<i>l</i>	<i>l</i>		
Part no.	Tip	blade	over	g	pc/box
72502	2	100	130	32	10
725025	2.5	100	130	32	10
72503	3	100	130	38	10
72504	4	150	185	66	10
72505	5	150	185	77	10
72506	6	200	240	137	10
72507	7	200	240	158	10
72508	8	200	240	182	10
72510	10	200	240	270	10
7253.32	3/32"	100	130	32	10
7257.64	7/64"	100	130	32	10
7251.8	1/8"	100	130	38	10
7255.32	5/32"	150	185	66	10
7253.16	3/16"	150	185	77	10
7257.32	7/32"	200	240	137	10
7251.4	1/4"	200	240	158	10
7255.16	5/16"	200	240	182	10
7253.8	3/8"	200	240	270	10

Spline key



768...K		<i>l</i>	<i>l</i>		
Part no.	Tip	short	long	g	pc/bag
76805K	M5	31	89	16	10
76806K	M6	36	97	30	10
76808K	M8	41	104	40	10
76810K	M10	48	112	86	10
76812K	M12	53	127	126	10
76814K	M14	55	141	200	5
76816K	M16	64	151	287	5
76818K	M18	79	175	287	5

Hex & hex ball point grip key



765...G		<i>l</i>	<i>l</i>		
Part no.	Tip	short	long	g	pc/box
76502G	2	53	126	15	10
765025G	2.5	53	126	18	10
76503G	3	53	126	21	10
76504G	4	68	183	34	10
76505G	5	68	183	72	10
76506G	6	82	240	90	10
76507G	7	82	240	110	10
76508G	8	82	240	154	10
76510G	10	82	240	275	10
76512G	12	82	240	369	10
7655.64G	5/64"	53	126	15	10
7653.32G	3/32"	53	126	17	10
7651.8G	1/8"	68	183	22	10
7655.32G	5/32"	68	183	34	10
7653.16G	3/16"	82	240	67	10
7651.4G	1/4"	82	240	95	10
7655.16G	5/16"	82	240	152	10
7653.8G	3/8"	82	240	254	10
7651.2G	1/2"	82	240	406	10

T-handle hex key



724		<i>l</i>	<i>l</i>		
Part no.	Tip	blade	over	g	pc/box
72402	2	100	130	30	10
724025	2.5	100	130	30	10
72403	3	100	130	34	10
72404	4	150	185	54	10
72405	5	150	185	66	10
72406	6	200	240	113	10
72407	7	200	240	136	10
72408	8	200	240	138	10
72410	10	200	240	240	10
72412	12	200	240	263	10
7243.32	3/32"	100	130	30	10
7247.64	7/64"	100	130	30	10
7241.8	1/8"	100	130	34	10
7245.32	5/32"	150	185	54	10
7243.16	3/16"	150	185	66	10
7247.32	7/32"	200	240	113	10
7241.4	1/4"	200	240	136	10
7245.16	5/16"	200	240	138	10
7243.8	3/8"	200	240	240	10

T-handle star key



726		<i>l</i>	<i>l</i>		
Part no.	Tip	blade	over	g	pc/box
72606	T6	100	130	32	10
72607	T7	100	130	33	10
72608	T8	100	130	33	10
72609	T9	100	130	33	10
72610	T10	100	130	33	10
72615	T15	100	130	39	10
72620	T20	100	135	52	10
72625	T25	100	135	58	10
72627	T27	200	240	58	10
72630	T30	200	240	58	10
72640	T40	200	240	68	10
72645	T45	200	240	79	10
72650	T50	200	240	93	10
72655	T55	200	240	130	10
72623520	T20	200	235	56	10
72623525	T25	200	235	68	10

T-handle star tamperproof key



727		<i>l</i>	<i>l</i>		
Part no.	Tip	blade	over	g	pc/box
72706	T-6H	100	130	30	10
72707	T-7H	100	130	30	10
72708	T-8H	100	130	30	10
72709	T-9H	100	130	30	10
72710	T-10H	100	130	30	10
72715	T-15H	100	130	34	10
72720	T-20H	100	135	34	10
72725	T-25H	100	135	54	10
72727	T-27H	200	240	51	10
72730	T-30H	200	240	102	10
72740	T-40H	200	240	122	10
72745	T-45H	200	240	144	10
72750	T-50H	200	240	170	10
72755	T-55H	200	240	258	10
72723520	T-20H	200	235	56	10
72723525	T-25H	200	235	68	10

T-handle hex socket driver



774		<i>l</i>	<i>l</i>		
Part no.	Tip	blade	over	g	pc/box
77430004	4	260	300	121	10
774300045	4.5	260	300	122	10
77430005	5	260	300	122	10
774300055	5.5	260	300	127	10
77430006	6	260	300	130	10
77430007	7	260	300	133	10
77430008	8	260	300	137	10
77430009	9	260	300	139	10
77430010	10	260	300	202	10
77430011	11	260	300	202	10
77430012	12	260	300	204	10
77430013	13	260	300	224	10
77430014	14	260	300	270	10
77430015 <small>NEW</small>	15	260	300	290	10
77430017	17	260	300	308	10
7743003.16	3/16"	260	300	122	10
7743001.4	1/4"	260	300	127	10
7743009.32	9/32"	260	300	136	10
7743005.16	5/16"	260	300	137	10
77430011.32	11/32"	260	300	142	10
7743003.8	3/8"	260	300	202	10
7743007.16	7/16"	260	300	202	10
7743001.2	1/2"	260	300	204	10
7743009.16	9/16"	260	300	270	10
7743005.8	5/8"	260	300	308	10

T-handle star socket driver



776		<i>l</i>	<i>l</i>		
Part no.	Tip	blade	over	g	pc/box
77604	E4	260	300	121	10
77605	E5	260	300	121	10
77606	E6	260	300	123	10
77607	E7	260	300	141	10
77608	E8	260	300	145	10
77610	E10	260	300	148	10
77611	E11	260	300	156	10
77612	E12	260	300	218	10
77614	E14	260	300	237	10
77616	E16	260	300	262	10

Adjustable 3-way T-shaped hex key



764...TA		<i>l</i>	<i>l</i>		
Part no.	Tip	blade	width	g	pc/box
76402TA	2	120	62	22	10
764025TA	2.5	125	61	22	10
76403TA	3	125	75	24	10
76404TA	4	180	90	60	10
76405TA	5	180	90	64	10
76406TA	6	210	106	127	10
76408TA	8	250	125	208	10
76410TA	10	300	150	388	5
76412TA	12	320	160	566	5
76414TA	14	340	170	803	5

3-Way T-shaped hex key



764...T		<i>l</i>	<i>l</i>		
Part no.	Tip	blade	width	g	pc/box
76402T	2	125	62	34	10
764025T	2.5	125	62	34	10
76403T	3	150	75	41	10
764035T	3.5	150	75	42	10
76404T	4	180	90	60	10
764045T	4.5	180	90	69	10
76405T	5	180	90	69	10
76406T	6	210	105	124	10
76407T	7	210	105	133	10
76408T	8	250	125	219	10
76409T	9	280	140	366	10
76410T	10	300	150	405	5
76412T	12	320	160	552	5
76414T	14	340	170	798	5

3-Way T-shaped star key



766...T		<i>l</i>	<i>l</i>		
Part no.	Tip	blade	width	g	pc/box
76606T	T6	125	62	20	10
76607T	T7	125	62	20	10
76608T	T8	125	62	20	10
76609T	T9	125	62	20	10
76610T	T10	150	75	25	10
76615T	T15	150	75	25	10
76620T	T20	150	75	25	10
76625T	T25	180	90	60	10
76627T	T27	180	90	60	10
76630T	T30	180	90	62	10
76640T	T40	210	105	135	10
76645T	T45	210	105	138	10
76650T	T50	250	125	220	10
76655T	T55	300	150	450	10
76660 T	T60	320	160	650	5

T-shaped hex socket driver



774...A		<i>l</i>	<i>l</i>		
Part no.	Tip	blade	width	g	pc/box
77406A	6	300	200	220	10
77407A	7	300	200	220	10
77408A	8	300	200	279	10
77409A	9	300	200	285	10
77410A	10	300	200	294	10
77411A	11	300	200	318	10
77412A	12	300	200	432	10
77413A	13	300	200	346	10
77414A	14	300	200	422	10
77415A	15	300	200	480	10
77416A	16	300	200	510	10
77417A	17	300	200	542	10
77418A	18	300	200	600	10
77419A	19	300	200	620	5
77420A	20	300	200	650	5
77421A	21	300	200	715	5
77422A	22	300	200	715	5
77424A	24	300	200	702	5
7741.4A	1/4"	300	200	220	10
7745.16A	5/16"	300	200	279	10
7743.8A	3/8"	300	200	294	10
7747.16A	7/16"	300	200	318	10
7741.2A	1/2"	300	200	342	10
7749.16A	9/16"	300	200	422	10
7745.8A	5/8"	300	200	510	10
7743.4A	3/4"	300	200	620	5

Adjustable T-shaped hex socket driver

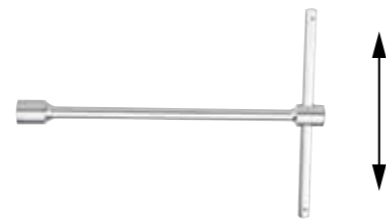

774...B		<i>l</i>	<i>l</i>		
Part no.	Tip	blade	width	g	pc/box
77407B	7	220	200	190	10
77408B	8	240	200	195	10
77410B	10	260	200	265	10
77412B	12	260	200	380	10
77413B	13	260	200	380	10
77414B	14	260	200	385	10
77417B	17	290	250	500	5
77419B	19	290	250	580	5
77422B	22	315	250	715	5

3/8"DR. Long universal socket driver (ball type)



784...B		<i>l</i>	<i>l</i>	
Part no.	Tip	blade	width	g
784332008B	8	320	200	338
784332010B	10	320	200	338
784332011B	11	320	200	340
784332012B	12	320	200	340
784332013B	13	320	200	340
784332014B	14	320	200	360
784345008B	8	450	200	406
784345010B	10	450	200	406
784345011B	11	450	200	408
784345012B	12	450	200	408
784345013B	13	450	200	408
784345014B	14	450	200	428
784360008B	8	600	200	486
784360010B	10	600	200	486
784360011B	11	600	200	488
784360012B	12	600	200	488
784360013B	13	600	200	488
784360014B	14	600	200	508

3/8"DR. Long universal socket driver (joint type)



784...U		<i>l</i>	<i>l</i>	
Part no.	Tip	blade	width	g
784332008U	8	320	200	350
784332010U	10	320	200	350
784332011U	11	320	200	352
784332012U	12	320	200	352
784332013U	13	320	200	352
784332014U	14	320	200	372
784345008U	8	450	200	418
784345010U	10	450	200	418
784345011U	11	450	200	420
784345012U	12	450	200	420
784345013U	13	450	200	420
784345014U	14	450	200	440
784360008U	8	600	200	498
784360010U	10	600	200	498
784360011U	11	600	200	500
784360012U	12	600	200	500
784360013U	13	600	200	500
784360014U	14	600	200	520

Long universal socket driver (joint type)



784...U		<i>l</i>	<i>l</i>	
Part no.	Tip	blade	width	g
1/4"DR.				
784206U	6	400	165	210
784207U	7	400	165	210
784208U	8	400	165	210
784209U	9	450	175	240

784...U		<i>l</i>	<i>l</i>	
Part no.	Tip	blade	width	g
3/8"DR.				
784310U	10	450	175	392
784311U	11	450	175	394
784312U	12	450	175	395
784313U	13	450	175	425
784314U	14	500	180	425
784315U	15	500	180	430
784316U	16	500	180	430
784317U	17	500	180	430
1/2"DR.				
784418U	18	500	180	820
784419U	19	500	220	880
784420U	20	500	220	880
784421U	21	500	220	900
784422U	22	500	220	900
784424U	24	500	220	920

Long universal square driver (joint type)



804...U		<i>l</i>	<i>l</i>	
Part no.	Drive	blade	width	g
8042400U	1/4"DR.	400	150	218
8042500U	1/4"DR.	500	150	258
8043320U	3/8"DR.	320	200	318
8043450U	3/8"DR.	450	200	408
8043600U	3/8"DR.	600	200	512
8043700U	3/8"DR.	700	200	582
8044500U	1/2"DR.	500	250	956
8044700U	1/2"DR.	700	250	1252

13pc 1/4"DR. Socket set



2133 48/12.0/13.0/1.4' Δ 270g

13pc 4; 4.5; 5; 5.5; 6; 7; 8; 9; 10; 11; 12; 13; 14 mm

2133-5 48/12.0/13.0/1.4' Δ 270g

13pc 4; 4.5; 5; 5.5; 6; 7; 8; 9; 10; 11; 12; 13; 14 mm

11pc 1/4"DR. Deep socket set



21115 48/17.8/18.8/1.4' Δ 370g

11pc 4; 5; 6; 7; 8; 9; 10; 11; 12; 13; 14 mm (50mmL)

21115-9 48/17.8/18.8/1.4' Δ 370g

11pc 4; 5; 6; 7; 8; 9; 10; 11; 12; 13; 14 mm (50mmL)

13pc 1/4"DR. Deep socket set



2138 48/20.2/21.2/1.2' Δ 398g

13pc 4; 4.5; 5; 5.5; 6; 7; 8; 9; 10; 11; 12; 13; 14 mm (50mmL)

2138-5 48/20.2/21.2/1.2' Δ 398g

13pc 4; 4.5; 5; 5.5; 6; 7; 8; 9; 10; 11; 12; 13; 14 mm (50mmL)

11pc 1/4"DR. Socket set (SAE)



21110 48/11.4/12.4/1.2' Δ 238g

11pc 5/32"; 3/16"; 7/32"; 1/4"; 9/32"; 5/16"; 11/32"; 3/8"; 7/16"; 1/2"; 9/16"

21110-5 48/11.4/12.4/1.2' Δ 238g

11pc 5/32"; 3/16"; 7/32"; 1/4"; 9/32"; 5/16"; 11/32"; 3/8"; 7/16"; 1/2"; 9/16"

11pc 1/4"DR. Deep socket set (SAE)



21110D 48/18.4/19.4/1.4' Δ 383g

11pc 5/32"; 3/16"; 7/32"; 1/4"; 9/32"; 5/16"; 11/32"; 3/8"; 7/16"; 1/2"; 9/16" (50mmL)

21110D-5 48/18.4/19.4/1.4' Δ 383g

11pc 5/32"; 3/16"; 7/32"; 1/4"; 9/32"; 5/16"; 11/32"; 3/8"; 7/16"; 1/2"; 9/16" (50mmL)

6pc 1/4"DR. Star socket set



2062S 100/11.0/12.0/2' Δ 106g

6pc E4; E5; E6; E7; E8; E10

10pc 1/4"DR. Star socket set



21016 48/8.0/9.0/1.4' Δ 166g

10pc E4; E5; E6; E7; E8; E10; E11; E12; E14; E16

6pc 1/4"DR. Star deep socket set



2062 60/10.2/11.2/1.5' Δ 180g

6pc E4; E5; E6; E7; E8; E10 (50mmL)

10pc 1/4"DR. Star deep socket set



21016D 48/14.5/15.5/1.4' Δ 302g

10pc E4; E5; E6; E7; E8; E10; E11; E12; E14; E16 (50mmL)

14pc 1/4"DR. Spline socket set



2144Q 48/11.0/12.0/1' Δ 230g

14pc 3.2; 4; 4.5; 5; 5.5; 6; 7; 8; 9; 10; 11; 12; 13; 14 mm

13pc 1/4"DR. Spline deep socket set



2138Q 48/21.0/22.0/1.2' Δ 438g

13pc 4; 4.5; 5; 5.5; 6; 7; 8; 9; 10; 11; 12; 13; 14 mm (50mmL)

10pc 1/4"DR. Phillips, pozidriv, slotted socket bit set

NEW



21017 48/9.1/10.1/1.4' 190g

	4pc	PH.0; PH.1; PH.2; PH.3 (32mmL)
	2pc	PZ.1; PZ.2 (32mmL)
	4pc	4; 5.5; 6.5; 7 mm (32mmL)

7pc 1/4"DR. Hex socket bit set



2073 100/15.0/16.0/1.8' 150g

	7pc	3; 4; 5; 6; 7; 8; 10 mm (32mmL)
--	-----	---------------------------------

2073S 100/15.0/16.0/1.8' 150g

	7pc	1/8"; 5/32"; 3/16"; 7/32"; 1/4"; 5/16"; 3/8" (32mmL)
--	-----	--

8pc 1/4"DR. Star socket bit set

NEW



20812 48/7.3/8.3/1.4' 152g

	8pc	T8; T10; T15; T20; T25; T27; T30; T40 (32mmL)
--	-----	---

11pc 1/4" & 3/8" Star socket bit set



2111I 48/19.6/20.6/1.4' 394g

	6pc	1/4"DR. T10; T15; T20; T25; T27; T30 (32mmL)
	5pc	3/8"DR. T40; T45; T50; T55; T60 (50mmL)

8pc 1/4"DR. Star tamperproof socket bit set

NEW



20812T 48/7.3/8.3/1.4' 152g

	8pc	T-8H; T-10H; T-15H; T-20H; T-25H; T-27H; T-30H; T-40H (32mmL)
--	-----	---

11pc 1/4" & 3/8" Star tamperproof socket bit set



2112I 48/19.4/20.4/1.4' 387g

	6pc	1/4"DR. T-10H; T-15H; T-20H; T-25H; T-27H; T-30H (32mmL)
	5pc	3/8"DR. T-40H; T-45H; T-50H; T-55H; T-60H (50mmL)

7pc 1/4"DR. Five-sided star tamperproof socket bit set



20711 100/14.5/15.5/1.8' 145g

	7pc	TS10; TS15; TS20; TS25; TS27; TS30; TS40 (32mmL)
--	-----	--

4pc 1/4"DR. Extension set

NEW

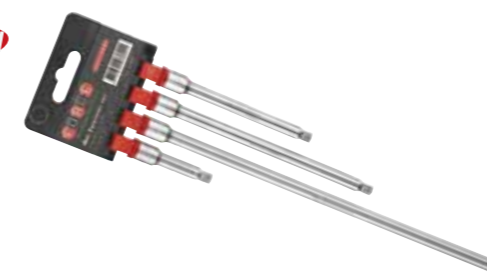

2049 80/20.5/21.5/1' 252g

	4pc	2"(50mm); 4"(100mm); 6"(150mm); 10"(250mm)
--	-----	--

4pc 1/4"DR. Ratchet handle set



2045 6/10.7/11.7/0.9' 1220g

	1pc	5-25 Nm, 270mmL (6472270)
	1pc	QR pear ratchet handle 20teeth (802215)
	1pc	QR flexible pear ratchet handle 20teeth (802218)
	1pc	QR stubby pear ratchet handle 20teeth (802219)

29pc 1/4" & 3/8" & 1/2" Star set



2303 10/16.5/17.5/0.7' 1650g

	4pc	1/4"DR. E5; E6; E7; E8
	3pc	3/8"DR. E10; E12; E14
	3pc	1/2"DR. E16; E18; E20
	5pc	1/4" T10; T20; T25; T27; T30 (25mmL)
	3pc	5/16" T40; T45; T50 (35mmL)
	2pc	1/2"DR. T55; T60 (55mmL)
	1pc	1/4" T25 (65mmL)
	1pc	1/4" T-30H (30mmL)
	1pc	1/4"DR.x1/4"(F)
	1pc	3/8"DR.x5/16"(F)
	1pc	1/2"DR.x5/16"(F)
	4pc	E6xE8; E10xE12; E14xE18; E20xE24

41pc 1/4"DR. Combination set

NEW











2413 12/13.2/14.2/1.1' 1100g



	10pc	5; 5.5; 6; 7; 8; 9; 10; 11; 12; 13 mm
	3pc	1/4" PH.1; PH.2; PH.3 (30mmL)
	3pc	1/4" PZ.1; PZ.2; PZ.3 (30mmL)
	4pc	1/4" 4; 5.5; 6; 6.5 mm (30mmL)
	5pc	1/4" 3; 4; 5; 6; 7 mm (30mmL)
	6pc	1/4" T10; T15; T20; T25; T30; T40 (30mmL)
	1pc	T mini ratchet handle 48teeth (802220)
	2pc	Wobble extension 3"(75mm); 6"(150mm)
	1pc	Magnetic 1/4"DR.x1/4"(F)
	1pc	QR 1/4"inhex 6"(150mm) (8148)
	5pc	8; 10; 12; 13; 14 mm

19pc 1/4"DR. Socket combination set





2203  15/14.0/15.0/1'  934g

	13pc	4; 4.5; 5; 5.5; 6; 7; 8; 9; 10; 11; 12; 13; 14 mm
	1pc	QR pear ratchet handle 24teeth (80222)
	2pc	2"(50mm); 6"(150mm)
	1pc	4.5"(115mm)
	1pc	1/4"
	1pc	6"(150mm) with 1/4"DR.(F)

2203-5  15/14.0/15.0/1'  934g



Changed items

	13pc	4; 4.5; 5; 5.5; 6; 7; 8; 9; 10; 11; 12; 13; 14 mm
---	------	---



2203-72  15/14.0/15.0/1'  934g

Changed items

	1pc	Round ratchet handle 72teeth (80229)
---	-----	--------------------------------------



2203-72-5  15/14.0/15.0/1'  934g





Changed items



	13pc	4; 4.5; 5; 5.5; 6; 7; 8; 9; 10; 11; 12; 13; 14 mm
	1pc	Round ratchet handle 72teeth (80229)

24pc 1/4"DR. 6pt. Flank socket combination set



2253  15/15.5/16.5/1'  1033g

	11pc	4; 5; 5.5; 6; 7; 8; 9; 10; 11; 12; 13 mm
	9pc	5; 6; 7; 8; 9; 10; 11; 12; 13 mm (50mmL)
	1pc	QR pear ratchet handle 36teeth (80225)
	2pc	2"(50mm); 6"(150mm)
	1pc	6"(150mm) with 1/4"DR.(F)



2253-72  15/15.5/16.5/1'  1033g









Changed items



	1pc	Round ratchet handle 72teeth (80229)
---	-----	--------------------------------------

27pc 1/4"DR. Socket combination set





2281  15/14.8/15.8/1'  986g

	11pc	4; 5; 6; 7; 8; 9; 10; 11; 12; 13; 14 mm
	3pc	PH.1; PH.2; PH.3 (32mmL)
	3pc	4; 5.5; 7 mm (32mmL)
	4pc	3; 4; 5; 6 mm (32mmL)
	1pc	QR pear ratchet handle 24teeth (80222)
	2pc	2"(50mm); 6"(150mm)
	1pc	4.5"(115mm)
	1pc	1/4"
	1pc	6"(150mm) with 1/4"DR.(F)

2281-5  15/14.8/15.8/1'  986g



Changed items

	11pc	4; 5; 6; 7; 8; 9; 10; 11; 12; 13; 14 mm
---	------	---



2281-72  15/14.8/15.8/1'  986g

Changed items

	1pc	Round ratchet handle 72teeth (80229)
---	-----	--------------------------------------



2281-72-5  15/14.8/15.8/1'  986g











Changed items



	11pc	4; 5; 6; 7; 8; 9; 10; 11; 12; 13; 14 mm
	1pc	Round ratchet handle 72teeth (80229)

29pc 1/4"DR. Socket combination set





2292  20/14.8/15.8/1'  740g

	12pc	4; 4.5; 5; 5.5; 6; 7; 8; 9; 10; 11; 12; 13 mm
	2pc	PH.1; PH.2 (32mmL)
	2pc	PZ.1; PZ.2 (32mmL)
	3pc	4; 5.5; 7 mm (32mmL)
	5pc	3; 4; 5; 6; 8 mm (32mmL)
	1pc	QR pear ratchet handle 24teeth (80222)
	1pc	2"(50mm)
	1pc	4.5"(115mm)
	1pc	1/4"
	1pc	6"(150mm) with 1/4"DR.(F)

2292-7  20/14.8/15.8/1'  740g

Changed items

	12pc	4; 4.5; 5; 5.5; 6; 7; 8; 9; 10; 11; 12; 13 mm
---	------	---



2292-9  20/14.8/15.8/1'  740g











Changed items

	12pc	4; 4.5; 5; 5.5; 6; 7; 8; 9; 10; 11; 12; 13 mm
---	------	---

40pc 1/4"DR. Spline socket combination set

















2405Q  15/14.5/15.5/1'  967g



	13pc	4; 4.5; 5; 5.5; 6; 7; 8; 9; 10; 11; 12; 13; 14 mm
	2pc	1/4" PH.1; PH.2 (25mmL)
	2pc	1/4" PZ.1; PZ.2 (25mmL)
	6pc	1/4" 3; 4; 5; 6; 7; 8 mm (25mmL)
	7pc	1/4" T10; T15; T20; T25; T27; T30; T40 (25mmL)
	5pc	1/4" M4; M5; M6; M8; M10 (25mmL)
	1pc	QR pear ratchet handle 24teeth (80222)
	1pc	4"(100mm)
	1pc	1/4"
	1pc	1/4"DR.x1/4"(F)
	1pc	6"(150mm) with 1/4"DR.(F)

42pc 1/4"DR. 6pt. Flank socket combination set





2421  20/18.0/19.0/0.82'  900g

	14pc	3.2; 4; 4.5; 5; 5.5; 6; 7; 8; 9; 10; 11; 12; 13; 14 mm
	3pc	1/4" PH.1; PH.2; PH.3 (25mmL)
	3pc	1/4" PZ.1; PZ.2; PZ.3 (25mmL)
	3pc	1/4" 4; 5.5; 6.5 mm (25mmL)
	5pc	1/4" 3; 4; 5; 6; 8 mm (25mmL)
	6pc	1/4" T10; T15; T20; T25; T30; T40 (25mmL)
	1pc	Round ratchet handle 72teeth (80229)
	2pc	2"(50mm); 6"(150mm)
	1pc	1/4"
	1pc	3/8"(F)x1/4"(M) for extension
	1pc	1/4"DR.x1/4"(F)
	1pc	Magnetic socket pick-up (25mmL)
	1pc	6"(150mm) with 1/4"DR.(F)

2421-8  20/18.0/19.0/0.82'  900g

Changed items

	1pc	QR pear ratchet handle 72teeth (80228)
---	-----	--



2421-2  20/18.0/19.0/0.82'  900g













Changed items

	1pc	QR pear ratchet handle 24teeth (80222)
---	-----	--

42pc 1/4"DR. 6pt. Flank socket combination set

















2421F  20/18.0/19.0/0.82'  900g

	14pc	3.2; 4; 4.5; 5; 5.5; 6; 7; 8; 9; 10; 11; 12; 13; 14 mm
	3pc	1/4" PH.1; PH.2; PH.3 (25mmL)
	3pc	1/4" PZ.1; PZ.2; PZ.3 (25mmL)
	3pc	1/4" 4; 5.5; 6.5 mm (25mmL)
	5pc	1/4" 3; 4; 5; 6; 8 mm (25mmL)
	6pc	1/4" T10; T15; T20; T25; T30; T40 (25mmL)
	1pc	QR flexible pear ratchet handle 20teeth (802218)
	2pc	2"(50mm); 6"(150mm)
	1pc	1/4"
	1pc	3/8"(F)x1/4"(M) for extension
	1pc	1/4"DR.x1/4"(F)
	1pc	Magnetic socket pick-up (25mmL)
	1pc	6"(150mm) with 1/4"DR.(F)

46pc 1/4"DR. Socket combination set

















2462  10/12.5/13.5/0.8'  1250g



	13pc	4; 4.5; 5; 5.5; 6; 7; 8; 9; 10; 11; 12; 13; 14 mm
	3pc	PH.1; PH.2; PH.3 (32mmL)
	3pc	PZ.1; PZ.2; PZ.3 (32mmL)
	3pc	4; 5.5; 7 mm (32mmL)
	6pc	3; 4; 5; 6; 7; 8 mm (32mmL)
	7pc	T8; T10; T15; T20; T25; T30; T40 (32mmL)
	1pc	QR pear ratchet handle 24teeth (80222)
	2pc	2"(50mm); 4"(100mm)
	1pc	4.5"(115mm)
	1pc	1/4"
	1pc	Flexible extension 5.8"(145mm)
	1pc	6"(150mm) with 1/4"DR.(F)
	4pc	1.3; 1.5; 2; 2.5 mm

46pc 1/4"DR. Socket combination set





2461  10/13.0/14.0/1.3'  1300g

	13pc	4; 4.5; 5; 5.5; 6; 7; 8; 9; 10; 11; 12; 13; 14 mm
	4pc	8; 10; 12; 13 mm (50mmL)
	3pc	PH.1; PH.2; PH.3 (32mmL)
	3pc	PZ.1; PZ.2; PZ.3 (32mmL)
	3pc	4; 5.5; 6.5 mm (32mmL)
	5pc	3; 4; 5; 6; 8 mm (32mmL)
	6pc	T10; T15; T20; T25; T30; T40 (32mmL)
	1pc	QR pear ratchet handle 24teeth (80222)
	2pc	2"(50mm); 4"(100mm)
	1pc	4.5"(115mm)
	1pc	1/4"
	1pc	6"(150mm) with 1/4"DR.(F)
	3pc	1.5; 2; 2.5 mm

2461-5  10/13.0/14.0/1.3'  1300g



Changed items













	13pc	4; 4.5; 5; 5.5; 6; 7; 8; 9; 10; 11; 12; 13; 14 mm
	4pc	8; 10; 12; 13 mm (50mmL)



56pc 1/4"DR. 6pt. Flank socket combination set

NEW





2561  10/18.6/19.6/1'  1862g

	13pc	4; 4.5; 5; 5.5; 6; 7; 8; 9; 10; 11; 12; 13; 14 mm
	11pc	5; 5.5; 6; 7; 8; 9; 10; 11; 12; 13; 14 mm (50mmL)
	4pc	PH.0; PH.1; PH.2; PH.3 (32mmL)
	2pc	PZ.1; PZ.2 (32mmL)
	4pc	4; 5.5; 6.5; 7 mm (32mmL)
	7pc	3; 4; 5; 6; 7; 8; 10 mm (32mmL)
	8pc	T8; T10; T15; T20; T25; T27; T30; T40 (32mmL)
	1pc	QR pear ratchet handle 24teeth (80222)
	2pc	2"(50mm); 4"(100mm)
	1pc	4.5"(115mm)
	1pc	1/4"
	1pc	1/4"Hex-1/4"Sq. (25mmL)
	1pc	6"(150mm) with 1/4"DR.(F)

2561-4  10/18.6/19.6/1'  1862g



Changed items

	1pc	QR thin pear ratchet handle 24teeth (80224)
---	-----	---

2561-27  10/18.6/19.6/1'  1862g

Changed items

	1pc	QR curved-shank ratchet handle 36teeth (80227)
---	-----	--

2561-8  10/18.6/19.6/1'  1862g

Changed items

	1pc	QR pear ratchet handle 72teeth (80228)
---	-----	--

56pc 1/4"DR. 6pt. Flank socket combination set

NEW



2561T		10/18.6/19.6/1'		1862g
	13pc	4; 4.5; 5; 5.5; 6; 7; 8; 9; 10; 11; 12; 13; 14 mm		
	11pc	5; 5.5; 6; 7; 8; 9; 10; 11; 12; 13; 14 mm (50mmL)		
	4pc	PH.0; PH.1; PH.2; PH.3 (32mmL)		
	2pc	PZ.1; PZ.2 (32mmL)		
	4pc	4; 5.5; 6.5; 7 mm (32mmL)		
	7pc	3; 4; 5; 6; 7; 8; 10 mm (32mmL)		
	8pc	T-8H; T-10H; T-15H; T-20H; T-25H; T-27H; T-30H; T-40H (32mmL)		
	1pc	QR pear ratchet handle 24teeth (80222)		
	2pc	2"(50mm); 4"(100mm)		
	1pc	4.5"(115mm)		
	1pc	1/4"		
	1pc	1/4"Hex-1/4"Sq. (25mmL)		
	1pc	6"(150mm) with 1/4"DR.(F)		

2561T-4		10/18.6/19.6/1'		1862g
Changed items				
	1pc	QR thin pear ratchet handle 24teeth (80224)		

2561T-27		10/18.6/19.6/1'		1862g
Changed items				
	1pc	QR curved-shank ratchet handle 36teeth (80227)		

2561T-8		10/18.6/19.6/1'		1862g
Changed items				
	1pc	QR pear ratchet handle 72teeth (80228)		

65pc 1/4"DR. 6pt. Flank socket combination set



2641		6/15.0/16.0/0.9'		2500g
	14pc	3.2; 4; 4.5; 5; 5.5; 6; 7; 8; 9; 10; 11; 12; 13; 14 mm		
	9pc	5; 6; 7; 8; 9; 10; 11; 12; 13 mm (50mmL)		
	3pc	PH.1; PH.2; PH.3 (32mmL)		
	3pc	PZ.1; PZ.2; PZ.3 (32mmL)		
	3pc	4; 5.5; 6.5 mm (32mmL)		
	7pc	3; 4; 5; 6; 7; 8; 10 mm (32mmL)		
	8pc	T8; T10; T15; T20; T25; T27; T30; T40 (32mmL)		
	1pc	Round ratchet handle 72teeth (80229)		
	3pc	2"(50mm); 4"(100mm); 6"(150mm)		
	1pc	4.5"(115mm)		
	1pc	1/4"		
	1pc	Magnetic socket pick-up (25mmL)		
	1pc	6"(150mm) with 1/4"DR.(F)		
	10pc	1.27; 1.5; 2; 2.5; 3; 4; 5; 6; 8; 10 mm (5102XLB)		

2641-8		6/15.0/16.0/0.9'		2500g
Changed items				
	1pc	QR pear ratchet handle 72teeth (80228)		

57pc 1/4"DR. 6pt. Flank & star socket combination set



2571		15/21.0/22.0/1'		1400g
	13pc	4; 4.5; 5; 5.5; 6; 7; 8; 9; 10; 11; 12; 13; 14 mm		
	4pc	6; 7; 8; 10 mm (50mmL)		
	6pc	E4; E5; E6; E7; E8; E10		
	3pc	PH.1; PH.2; PH.3 (32mmL)		
	3pc	PZ.1; PZ.2; PZ.3 (32mmL)		
	3pc	4; 5.5; 6.5 mm (32mmL)		
	7pc	3; 4; 5; 6; 7; 8; 10 mm (32mmL)		
	8pc	T8; T10; T15; T20; T25; T27; T30; T40 (32mmL)		
	1pc	Round ratchet handle 72teeth (80229)		
	2pc	2"(50mm); 4"(100mm)		
	1pc	4.5"(115mm)		
	1pc	1/4"		
	1pc	6"(150mm) with 1/4"DR.(F)		
	4pc	1.3; 1.5; 2; 2.5 mm		

71pc 1/4"DR. 6pt. Flank & star socket combination set

NEW



2711		10/23.4/24.4/1.2'		2326g
	13pc	4; 4.5; 5; 5.5; 6; 7; 8; 9; 10; 11; 12; 13; 14 mm		
	11pc	5; 5.5; 6; 7; 8; 9; 10; 11; 12; 13; 14 mm (50mmL)		
	8pc	E4; E5; E6; E7; E8; E10; E11; E12		
	4pc	PH.0; PH.1; PH.2; PH.3 (32mmL)		
	2pc	PZ.1; PZ.2 (32mmL)		
	4pc	4; 5.5; 6.5; 7 mm (32mmL)		
	7pc	3; 4; 5; 6; 7; 8; 10 mm (32mmL)		
	8pc	T8; T10; T15; T20; T25; T27; T30; T40 (32mmL)		
	8pc	T-8H; T-10H; T-15H; T-20H; T-25H; T-27H; T-30H; T-40H (32mmL)		
	1pc	QR pear ratchet handle 72teeth (80228)		
	2pc	2"(50mm); 4"(100mm)		
	1pc	4.5"(115mm)		
	1pc	1/4"		
	1pc	6"(150mm) with 1/4"DR.(F)		

74pc 1/4"DR. 6pt. Flank & star socket combination set



2742 6/12.7/13.7/0.9' 1580g

	12pc	4; 4.5; 5; 5.5; 6; 7; 8; 9; 10; 11; 12; 13 mm
	12pc	4; 4.5; 5; 5.5; 6; 7; 8; 9; 10; 11; 12; 13 mm (50mmL)
	6pc	E4; E5; E6; E7; E8; E10
	6pc	E4; E5; E6; E7; E8; E10 (50mmL)
	3pc	PH.0; PH.1; PH.2 (32mmL)
	3pc	PZ.0; PZ.1; PZ.3 (32mmL)
	3pc	4; 5.5; 6.5 mm (32mmL)
	7pc	3; 4; 5; 6; 7; 8; 10 mm (32mmL)
	8pc	T8; T10; T15; T20; T25; T27; T30; T40 (32mmL)
	8pc	T-8H; T-10H; T-15H; T-20H; T-25H; T-27H; T-30H; T-40H (32mmL)
	1pc	T mini ratchet handle 48teeth (802220)
	3pc	2"(50mm); 4"(100mm); 6"(150mm)
	1pc	1/4"
	1pc	Magnetic socket pick-up (25mmL)

2742-18 6/12.7/13.7/0.9' 1580g

Changed items

	1pc	QR flexible pear ratchet handle 20teeth (802218)
--	-----	--

2742-8 6/12.7/13.7/0.9' 1580g

Changed items

	1pc	QR pear ratchet handle 72teeth (80228)
--	-----	--

91pc 1/4"DR. Socket combination set

NEW



2911 10/20.0/21.0/0.83' 2008g

	13pc	4; 4.5; 5; 5.5; 6; 7; 8; 9; 10; 11; 12; 13; 14 mm
	5pc	7; 8; 10; 12; 13 mm (50mmL)
	8pc	E4; E5; E6; E7; E8; E10; E11; E12
	8pc	T8; T10; T15; T20; T25; T27; T30; T40 (32mmL)
	8pc	T-8H; T-10H; T-15H; T-20H; T-25H; T-27H; T-30H; T-40H (32mmL)
	10pc	1/4" TS8; TS10; TS15; TS20; TS25; TS27; TS30; TS40; TS45; TS50 (25mmL)
	6pc	1/4" 2; 4; 6; 8; 10; 1/4" (25mmL)
	4pc	1/4" 1; 2; 3; 4 (25mmL)
	6pc	1/4" 4; 6; 8; 10; 12; 14 mm (25mmL)
	4pc	1/4" No.0; No.1; No.2; No.3 (25mmL)
	6pc	1/4" 2; 2.5; 3; 4; 5; 6 mm (25mmL)
	6pc	1/4" 5/64"; 3/32"; 7/64"; 1/8"; 9/64"; 5/32" (25mmL)
	1pc	QR pear ratchet handle 72teeth (80228)
	2pc	2"(50mm); 4"(100mm)
	1pc	4.5"(115mm)
	1pc	1/4"
	1pc	1/4"DR.x1/4"(F)
	1pc	6"(150mm) with 1/4"DR.(F)

2911Q 10/20.0/21.0/0.83' 2008g

Changed items

	13pc	Spline socket 4; 4.5; 5; 5.5; 6; 7; 8; 9; 10; 11; 12; 13; 14 mm
	5pc	Spline socket 7; 8; 10; 12; 13 mm (50mmL)

19pc 1/4"DR. Socket combination set (SAE)

NEW



2203S-5 15/14.0/15.0/1' 934g

	13pc	5/32"; 3/16"; 7/32"; 1/4"; 9/32"; 5/16"; 11/32"; 3/8"; 13/32"; 7/16"; 15/32"; 1/2"; 9/16"
	1pc	QR pear ratchet handle 24teeth (80222)
	2pc	2"(50mm); 6"(150mm)
	1pc	4.5"(115mm)
	1pc	1/4"
	1pc	6"(150mm) with 1/4"DR.(F)

2203S-9 15/14.0/15.0/1' 934g

Changed items

	13pc	5/32"; 3/16"; 7/32"; 1/4"; 9/32"; 5/16"; 11/32"; 3/8"; 13/32"; 7/16"; 15/32"; 1/2"; 9/16"
--	------	---

27pc 1/4"DR. 12pt. Flank socket combination set (SAE)



2281S 15/14.8/15.8/1' 986g

	11pc	5/32"; 3/16"; 7/32"; 1/4"; 9/32"; 5/16"; 11/32"; 3/8"; 7/16"; 1/2"; 9/16"
	3pc	PH.1; PH.2; PH.3 (32mmL)
	3pc	4; 5.5; 7 mm (32mmL)
	4pc	1/8"; 5/32"; 3/16"; 7/32" (32mmL)
	1pc	QR pear ratchet handle 24teeth (80222)
	2pc	2"(50mm); 6"(150mm)
	1pc	4.5"(115mm)
	1pc	1/4"
	1pc	6"(150mm) with 1/4"DR.(F)

42pc 1/4"DR. 6pt. Flank socket combination set (SAE)

NEW



2421S 20/18.0/19.0/0.82' 900g

	13pc	5/32"; 3/16"; 7/32"; 1/4"; 9/32"; 5/16"; 11/32"; 3/8"; 13/32"; 7/16"; 15/32"; 1/2"; 9/16"
	3pc	1/4" PH.1; PH.2; PH.3 (25mmL)
	3pc	1/4" PZ.1; PZ.2; PZ.3 (25mmL)
	3pc	1/4" 4; 5.5; 6.5 mm (25mmL)
	5pc	1/4" 1/8"; 5/32"; 3/16"; 1/4"; 5/16" (25mmL)
	6pc	1/4" T10; T15; T20; T25; T30; T40 (25mmL)
	1pc	Round ratchet handle 72teeth (80229)
	2pc	2"(50mm); 6"(150mm)
	1pc	1/4"
	1pc	3/8"(F)x1/4"(M) for extension
	1pc	1/4"(F)x3/8"(M)
	1pc	1/4"DR.x1/4"(F)
	1pc	Magnetic socket pick-up (25mmL)
	1pc	6"(150mm) with 1/4"DR.(F)

28pc 1/4"DR. 6pt. Flank socket combination set (S&M)



2285 10/15.3/16.3/0.83' 1550g

	11pc	4; 5; 6; 7; 8; 9; 10; 11; 12; 13; 14 mm
	11pc	5/32"; 3/16"; 7/32"; 1/4"; 9/32"; 5/16"; 11/32"; 3/8"; 7/16"; 1/2"; 9/16"
	1pc	QR pear ratchet handle 72teeth (80228)
	1pc	5.5"(140mm)
	2pc	2"(50mm); 6"(150mm)
	1pc	4.5"(115mm)
	1pc	1/4"

31pc 1/4"DR. Socket combination set (S&M)



2312 15/16.4/17.4/1' 1090g

	13pc	4; 4.5; 5; 5.5; 6; 7; 8; 9; 10; 11; 12; 13; 14 mm
	10pc	3/16"; 7/32"; 1/4"; 9/32"; 5/16"; 11/32"; 3/8"; 7/16"; 1/2"; 9/16"
	1pc	QR pear ratchet handle 24teeth (80222)
	2pc	2"(50mm); 6"(150mm)
	1pc	1/4"
	1pc	1/4"(F)x1/4"(M) for extension
	1pc	1/4"DR.x1/4"(F)
	1pc	Flexible extension 5.8"(145mm)
	1pc	6"(150mm) with 1/4"DR.(F)

2312-72-5 15/16.4/17.4/1' 1090g

Changed items		
	13pc	4; 4.5; 5; 5.5; 6; 7; 8; 9; 10; 11; 12; 13; 14 mm
	10pc	3/16"; 7/32"; 1/4"; 9/32"; 5/16"; 11/32"; 3/8"; 7/16"; 1/2"; 9/16"
	1pc	Round ratchet handle 72teeth (80229)

2312-5 15/16.4/17.4/1' 1090g

Changed items		
	13pc	4; 4.5; 5; 5.5; 6; 7; 8; 9; 10; 11; 12; 13; 14 mm
	10pc	3/16"; 7/32"; 1/4"; 9/32"; 5/16"; 11/32"; 3/8"; 7/16"; 1/2"; 9/16"
2312-72 15/16.4/17.4/1' 1090g		
Changed items		
	1pc	Round ratchet handle 72teeth (80229)

40pc 1/4"DR. 6pt. Flank socket combination set (S&M)



2402 10/15.4/16.4/1' 1540g

	12pc	4; 4.5; 5; 5.5; 6; 7; 8; 9; 10; 11; 12; 13 mm
	6pc	3/16"; 1/4"; 9/32"; 11/32"; 3/8"; 1/2"
	10pc	4; 5; 5.5; 6; 7; 8; 9; 10; 11; 13 mm (50mmL)
	4pc	3/16"; 1/4"; 3/8"; 1/2" (50mmL)
	1pc	QR pear ratchet handle 36teeth (80225)
	3pc	2"(50mm); 4"(100mm); 6"(150mm)
	1pc	4.5"(115mm)
	1pc	1/4"
	1pc	Flexible extension 5.8"(145mm)
	1pc	6"(150mm) with 1/4"DR.(F)

48pc 1/4"DR. 6pt. Flank socket combination set (S&M)



2481 10/23.0/24.0/1.2' 2310g

	11pc	4; 5; 6; 7; 8; 9; 10; 11; 12; 13; 14 mm
	10pc	3/16"; 7/32"; 1/4"; 9/32"; 5/16"; 11/32"; 3/8"; 7/16"; 1/2"; 9/16"
	11pc	4; 5; 6; 7; 8; 9; 10; 11; 12; 13; 14 mm (50mmL)
	10pc	3/16"; 7/32"; 1/4"; 9/32"; 5/16"; 11/32"; 3/8"; 7/16"; 1/2"; 9/16" (50mmL)
	1pc	QR pear ratchet handle 72teeth (80228)
	1pc	5.5"(140mm)
	2pc	2"(50mm); 6"(150mm)
	1pc	4.5"(115mm)
	1pc	1/4"

50pc 1/4"DR. 6pt Flank socket combination set (S&M)



2501A 10/20.6/21.6/1.2' 2100g

	11pc	4; 5; 6; 7; 8; 9; 10; 11; 12; 13; 14 mm
	11pc	5/32"; 3/16"; 7/32"; 1/4"; 9/32"; 5/16"; 11/32"; 3/8"; 7/16"; 1/2"; 9/16"
	4pc	PH.0; PH.1; PH.2; PH.3 (32mmL)
	2pc	PZ.1; PZ.2 (32mmL)
	3pc	4; 5.5; 6.5 mm (32mmL)
	7pc	3; 4; 5; 6; 7; 8; 10 mm (32mmL)
	5pc	1/8"; 5/32"; 3/16"; 7/32"; 1/4" (32mmL)
	1pc	QR pear ratchet handle 72teeth (80228)
	1pc	5.5"(140mm)
	2pc	2"(50mm); 6"(150mm)
	1pc	4.5"(115mm)
	1pc	1/4"
	1pc	6"(150mm) with 1/4"DR.(F)

50pc 1/4"DR. 6pt. Flank socket combination set (S&M)

NEW



2501B

20/20.8/21.8/1.2' △ 2100g

	11pc	4; 5; 6; 7; 8; 9; 10; 11; 12; 13; 14 mm
	11pc	5/32"; 3/16"; 7/32"; 1/4"; 9/32"; 5/16"; 11/32"; 3/8"; 7/16"; 1/2"; 9/16"
	2pc	PH.1; PH.2 (32mmL)
	7pc	3; 4; 5; 6; 7; 8; 10 mm (32mmL)
	5pc	1/8"; 5/32"; 3/16"; 7/32"; 1/4" (32mmL)
	7pc	T-10H; T-15H; T-20H; T-25H; T-27H; T-30H; T-40H (32mmL)
	1pc	QR pear ratchet handle 72teeth (80228)
	1pc	5.5"(140mm)
	2pc	2"(50mm); 6"(150mm)
	1pc	4.5"(115mm)
	1pc	1/4"
	1pc	6"(150mm) with 1/4"DR.(F)

74pc 1/4"DR. 6pt. Flank socket combination set (S&M)



2741

6/14.2/15.2/0.9' △ 1840g

	12pc	4; 4.5; 5; 5.5; 6; 7; 8; 9; 10; 11; 12; 13 mm
	6pc	3/16"; 1/4"; 9/32"; 11/32"; 3/8"; 1/2"
	12pc	4; 4.5; 5; 5.5; 6; 7; 8; 9; 10; 11; 12; 13 mm (50mmL)
	6pc	3/16"; 1/4"; 9/32"; 11/32"; 3/8"; 1/2" (50mmL)
	3pc	PH.1; PH.2; PH.3 (32mmL)
	3pc	PZ.1; PZ.2; PZ.3 (32mmL)
	4pc	3; 4; 5.5; 6.5 mm (32mmL)
	7pc	3; 4; 5; 6; 7; 8; 10 mm (32mmL)
	5pc	1/8"; 3/16"; 7/32"; 1/4"; 3/8" (32mmL)
	8pc	T8; T10; T15; T20; T25; T27; T30; T40 (32mmL)
	1pc	QR pear ratchet handle 20teeth (802215)
	3pc	2"(50mm); 4"(100mm); 6"(150mm)
	1pc	4.5"(115mm)
	1pc	1/4"
	1pc	Magnetic socket pick-up (25mmL)
	1pc	6"(150mm) with 1/4"DR.(F)

1/4"DR. Phillips socket bit



321				
Part no.	size	mm	g	pc/box
321320	PH.0	32	12	20
321321	PH.1	32	12	20
321322	PH.2	32	12	20
321323	PH.3	32	14	20
321324	PH.4	32	14	20

1/4"DR. Pozidriv socket bit



322				
Part no.	size	mm	g	pc/box
322320	PZ.0	32	12	20
322321	PZ.1	32	12	20
322322	PZ.2	32	12	20
322323	PZ.3	32	14	20
322324	PZ.4	32	14	20

1/4"DR. Slotted socket bit



323				
Part no.	size	mm	g	pc/box
3233203	0.5x3	32	12	20
3233204	0.8x4	32	12	20
32332055	1.0x5.5	32	12	20
3233206	1.0x6	32	12	20
32332065	1.2x6.5	32	12	20
3233207	1.2x7	32	12	20
323325.32	5/32"	32	12	20
323327.32	7/32"	32	12	20
323321.4	1/4"	32	12	20

1/4"DR. Hex socket bit



324				
Part no.	size	mm	g	pc/box
32432025 NEW	2.5	32	13	20
3243203	3	32	13	20
3243204	4	32	14	20
3243205	5	32	14	20
3243206	6	32	14	20
3243207	7	32	16	20
3243208	8	32	17	20
3243209	9	32	20	20
3243210	10	32	21	20
324321.8	1/8"	32	14	20
324325.32	5/32"	32	14	20
324323.16	3/16"	32	14	20
324327.32	7/32"	32	14	20
324321.4	1/4"	32	16	20
324325.16	5/16"	32	16	20
324323.8	3/8"	32	20	20

1/4"DR. Star socket bit



326				
Part no.	size	mm	g	pc/box
3263208	T8	32	13	20
3263209	T9	32	13	20
3263210	T10	32	13	20
3263215	T15	32	13	20
3263220	T20	32	14	20
3263225	T25	32	14	20
3263227	T27	32	14	20
3263230	T30	32	14	20
3263235	T35	32	14	20
3263240	T40	32	15	20
3269030	T30	90	26	10

• 3269030 for removing and replacing the screws on airbag of VW-Audi.

1/4"DR. Star tamperproof socket bit



327		<i>l</i>		
Part no.	size	mm	g	pc/box
3273208	T-8H	32	13	20
3273209 <small>NEW</small>	T-9H	32	13	20
3273210	T-10H	32	13	20
3273215	T-15H	32	13	20
3273220	T-20H	32	14	20
3273225	T-25H	32	14	20
3273227	T-27H	32	14	20
3273230	T-30H	32	14	20
3273235	T-35H	32	14	20
3273240	T-40H	32	14	20

1/4"DR. 6pt. Flank socket



525		<i>l</i>		
Part no.	size	mm	g	pc/box
525032	3.2	25	10	20
52504	4	25	10	20
525045	4.5	25	11	20
52505	5	25	11	20
525055	5.5	25	11	20
52506	6	25	11	20
52507	7	25	12	20
52508	8	25	12	20
52509	9	25	14	20
52510	10	25	15	20
52511	11	25	18	20
52512	12	25	21	20
52513	13	25	22	20
52514	14	25	36	20
5255.32	5/32"	25	11	20
5253.16	3/16"	25	11	20
5257.32	7/32"	25	11	20
5251.4	1/4"	25	11	20
5259.32	9/32"	25	12	20
5255.16	5/16"	25	12	20
52511.32	11/32"	25	14	20
5253.8	3/8"	25	14	20
52513.32	13/32"	25	16	20
5257.16	7/16"	25	18	20
52515.32	15/32"	25	20	20
5251.2	1/2"	25	21	20
5259.16	9/16"	25	22	20

1/4"DR. Five-sided star tamperproof socket bit



32F		<i>l</i>		
Part no.	size	mm	g	pc/box
32F3210	TS10	32	12	20
32F3215	TS15	32	12	20
32F3220	TS20	32	12	20
32F3225	TS25	32	12	20
32F3227	TS27	32	14	20
32F3230	TS30	32	14	20
32F3240	TS40	32	14	20

1/4"DR. 6pt. Flank deep socket



52550		<i>l</i>		
Part no.	size	mm	g	pc/box
5255004	4	50	14	20
52550045	4.5	50	16	20
5255005	5	50	17	20
52550055	5.5	50	18	20
5255006	6	50	20	20
5255007	7	50	22	20
5255008	8	50	27	20
5255009	9	50	29	20
5255010	10	50	34	20
5255011	11	50	40	20
5255012	12	50	41	20
5255013	13	50	52	20
5255014	14	50	54	20
525505.32	5/32"	50	14	20
525503.16	3/16"	50	17	20
525507.32	7/32"	50	18	20
525501.4	1/4"	50	20	20
525509.32	9/32"	50	22	20
525505.16	5/16"	50	27	20
5255011.32	11/32"	50	29	20
525503.8	3/8"	50	34	20
525507.16	7/16"	50	40	20
525501.2	1/2"	50	52	20
525509.16	9/16"	50	54	20

1/4"DR. Star socket



526		<i>l</i>		
Part no.	size	mm	g	pc/box
52604	E4	25	10	20
52605	E5	25	10	20
52606	E6	25	11	20
52607	E7	25	11	20
52608	E8	25	12	20
52610	E10	25	12	20
52611	E11	25	14	20
52612	E12	25	17	20
52614	E14	25	21	20
52616	E16	25	30	20

1/4"DR. Star deep socket



52650		<i>l</i>		
Part no.	size	mm	g	pc/box
5265004	E4	50	14	20
5265005	E5	50	19	20
5265006	E6	50	19	20
5265007	E7	50	21	20
5265008	E8	50	23	20
5265010	E10	50	28	20
5265011 <small>NEW</small>	E11	50	31	20
5265012	E12	50	32	20
5265014	E14	50	43	20
5265016	E16	50	53	20

1/4"DR. Surface drive socket



527		<i>l</i>		
Part no.	size	mm	g	pc/box
52704	4	25	10	20
527045	4.5	25	10	20
52705	5	25	10	20
527055	5.5	25	11	20
52706	6	25	11	20
52707	7	25	12	20
52708	8	25	12	20
52709	9	25	13	20
52710	10	25	15	20
52711	11	25	24	20
52712	12	25	28	20
52713	13	25	32	20
52714	14	25	36	20
5273.16	3/16"	25	11	20
5277.32	7/32"	25	11	20
5271.4	1/4"	25	12	20
5279.32	9/32"	25	12	20
5275.16	5/16"	25	12	20
52711.32	11/32"	25	13	20
5273.8	3/8"	25	15	20
5277.16	7/16"	25	24	20
5271.2	1/2"	25	32	20
5279.16	9/16"	25	38	20

1/4"DR. Surface drive deep socket



52750		<i>l</i>		
Part no.	size	mm	g	pc/box
5275004	4	50	17	20
52750045	4.5	50	17	20
4275005	5	50	17	20
52750055	5.5	50	17	20
5275006	6	50	20	20
5275007	7	50	20	20
5275008	8	50	24	20
5275009	9	50	30	20
5275010	10	50	36	20
5275011	11	50	46	20
5275012	12	50	50	20
5275013	13	50	52	20
5275014	14	50	53	20

1/4"DR. 12pt. Flank socket



529		<i>l</i>		
Part no.	size	mm	g	pc/box
529032	3.2	25	10	20
52904	4	25	10	20
529045	4.5	25	11	20
52905	5	25	11	20
529055	5.5	25	11	20
52906	6	25	11	20
52907	7	25	12	20
52908	8	25	12	20
52909	9	25	13	20
52910	10	25	15	20
52911	11	25	19	20
52912	12	25	20	20
52913	13	25	22	20
52914	14	25	25	20
5295.32	5/32"	25	11	20
5293.16	3/16"	25	11	20
5297.32	7/32"	25	11	20
5291.4	1/4"	25	12	20
5299.32	9/32"	25	12	20
5295.16	5/16"	25	12	20
52911.32	11/32"	25	13	20
5293.8	3/8"	25	15	20
52913.32	13/32"	25	15	20
5297.16	7/16"	25	19	20
52915.32	15/32"	25	20	20
5291.2	1/2"	25	22	20
5299.16	9/16"	25	25	20

1/4"DR. 12pt. Flank deep socket



52950		<i>l</i>		
Part no.	size	mm	g	pc/box
5295004	4	50	16	20
52950045	4.5	50	16	20
5295005	5	50	18	20
52950055	5.5	50	18	20
5295006	6	50	21	20
5295007	7	50	22	20
5295008	8	50	22	20
5295009	9	50	28	20
5295010	10	50	33	20
5295011	11	50	44	20
5295012	12	50	44	20
5295013	13	50	45	20
5295014	14	50	49	20
529505.32	5/32"	50	14	20
529503.16	3/16"	50	17	20
529507.32	7/32"	50	18	20
529501.4	1/4"	50	20	20
529509.32	9/32"	50	22	20
529505.16	5/16"	50	27	20
5295011.32	11/32"	50	29	20
529503.8	3/8"	50	34	20
529507.16	7/16"	50	40	20
529501.2	1/2"	50	52	20
529509.16	9/16"	50	52	20

1/4"DR. Spline socket



52Q							<i>l</i>		
Part no.	size	6point	12point	SAE	E-Torx	XZN	mm	g	pc/box
52Q032	3.2	3.2	3.2	1/8"	E4		25	10	20
52Q04	4	4	4	5/32"	E5	4	25	10	20
52Q045	4.5	4.5	4.5				25	10	20
52Q05	5	5	5	3/16"	E6	5	25	12	20
52Q055	5.5	5.5	5.5	7/32"	E7		25	12	20
52Q06	6	6	6		E8	6	25	12	20
52Q07	7	7	7	9/32"		7	25	12	20
52Q08	8	8	8	5/16"	E10	8	25	12	20
52Q09	9	9	9	11/32"	E11	9	25	18	20
52Q10	10	10	10	3/8"	E12	10	25	18	20
52Q11	11	11	11	7/16"	E14	11	25	24	20
52Q12	12	12	12	15/32"		12	25	28	20
52Q13	13	13	13	1/2"	E16		25	32	20
52Q14	14	14	14	9/16"	E18	14	25	36	20

1/4"DR. Spline deep socket



52Q50							<i>l</i>		
Part no.	size	6point	12point	SAE	E-Torx	XZN	mm	g	pc/box
52Q5004	4	4	4	5/32"	E5	4	50	14	20
52Q50045	4.5	4.5	4.5				50	16	20
52Q5005	5	5	5	3/16"	E6	5	50	16	20
52Q50055	5.5	5.5	5.5	7/32"	E7		50	20	20
52Q5006	6	6	6		E8	6	50	20	20
52Q5007	7	7	7	9/32"		7	50	20	20
52Q5008	8	8	8	5/16"	E10	8	50	24	20
52Q5009	9	9	9	11/32"	E11	9	50	30	20
52Q5010	10	10	10	3/8"	E12	10	50	36	20
52Q5011	11	11	11	7/16"	E14	11	50	46	20
52Q5012	12	12	12	15/32"		12	50	50	20
52Q5013	13	13	13	1/2"	E16		50	52	20
52Q5014	14	14	14	9/16"	E18	14	50	56	20

1/4"DR. Universal 6pt. flank socket



80525		<i>l</i>		
Part no.	socket	mm	g	pc/box
8052506	6	39	22	20
8052507	7	39	24	20
8052508	8	39	24	20
8052509	9	39	24	20

1/4"DR. Universal 6pt. flank deep socket



8052565		<i>l</i>		
Part no.	socket	mm	g	pc/box
805256505	5	65	29	20
805256506	6	65	31	20
805256507	7	65	36	20
805256508	8	65	38	20
805256509	9	65	38	20
805256510	10	65	44	20
805256511	11	65	49	20
805256512	12	65	49	20
805256513	13	65	50	20

1/4"DR. Swivel handle



8012140	<i>l</i>		
Part no.	mm	g	pc/box
8012140	140-5.5"	118	10

• Spare part available

1/4"DR. QR pear ratchet handle 24teeth



80222	<i>l</i>		
Part no.	mm	g	pc/box
80222	143	150	1

• Spare part available

1/4"DR. QR thin pear ratchet handle 24teeth



80224	<i>l</i>		
Part no.	mm	g	pc/box
80224	125	142	1

• Spare part available

1/4"DR. QR pear ratchet handle 36teeth



80225	<i>l</i>		
Part no.	mm	g	pc/box
80225	135	141	1

• Spare part available

1/4"DR. QR pear ratchet handle 72teeth

NEW



80228	l		
Part no.	mm	g	pc/box
80228	140	136	1

• Spare part available

1/4"DR. QR flexible pear ratchet handle 20teeth



802218	l		
Part no.	mm	g	pc/box
802218	127	146	1

• Spare part available

1/4"DR. Round ratchet handle 72teeth



802222	l		
Part no.	mm	g	pc/box
802222	123	114	1

• Spare part available

1/4"DR. Sliding T handle



8032115	l		
Part no.	mm	g	pc/box
8032115	115	42	10

1/4"DR. Round ratchet handle 72teeth



80229	l		
Part no.	mm	g	pc/box
80229	116	132	1

• Spare part available

1/4"DR. QR stubby pear ratchet handle 20teeth



802219	l		
Part no.	mm	g	pc/box
802219	100	104	1

* Spare part available

1/4"DR. Flexible round ratchet handle 72teeth



802223	l		
Part no.	mm	g	pc/box
802223	148	126	1

• Spare part available

1/4"DR. Extension



8042	l		
Part no.	mm	g	pc/box
8042050	50-2"	23	20
8042075	75-3"	34	10
8042100	100-4"	46	10
8042125	125-5"	54	10
8042150	150-6"	66	10
8042200	200-8"	87	10
8042250	250-10"	110	10
8042350	350-14"	139	10

1/4"DR. QR pear ratchet handle 20teeth



802215	l		
Part no.	mm	g	pc/box
802215	133	120	1

• Spare part available

1/4"DR. T mini ratchet handle 48teeth



802220	l		
Part no.	mm	g	pc/box
802220	110	77	10

• Spare part available

1/4"DR. QR curved-shank ratchet handle 36teeth

NEW



802227	l		
Part no.	mm	g	pc/box
802227	147	115	1

• Spare part available

1/4"DR. Wobble extension



8042..W	l		
Part no.	mm	g	pc/box
8042050W	50-2"	23	20
8042075W	75-3"	34	10
8042100W	100-4"	46	10
8042150W	150-6"	66	10
8042225W	225-9"	101	10
8042250W	250-10"	110	10

1/4"DR. Universal joint



80521	<i>l</i>		
Part no.	mm	g	pc/box
80521	37	23	20

1/4"DR. Long adapter



80923036		<i>l</i>		
Part no.	size	mm	g	pc/box
80923036	1/4"(F) x 3/8"(M)	36	20	20

1/4"DR. Flexible extension



8111		<i>l</i>		
Part no.	size	mm	g	pc/box
8111	1/4"DR.	145	61	10

1/4"DR. Spinner



8142		<i>l</i>		
Part no.	size	mm	g	pc/box
8142	1/4"DR.	100-4"	99	10

Adapter for 1/4"DR. extension



806		<i>l</i>		
Part no.	size	mm	g	pc/box
80622	1/4"(F)x1/4"(M)	26	15	50
80632	3/8"(F) x1/4"(M)	35	29	20

1/4"DR. Bit holder



81022		<i>l</i>		
Part no.	size	mm	g	pc/box
81022	1/4"DR.x1/4"inhex	25	14	50

1/4"DR. Flexible spinner



8113		<i>l</i>		
Part no.	size	mm	g	pc/box
8113	1/4"DR.	275-11"	151	10

1/4"DR. Spinner



8143		<i>l</i>		
Part no.	size	mm	g	pc/box
8143	1/4"DR. with 1/4"DR.(F)	150-6"	104	10

1/4"DR. Adapter



80923		<i>l</i>		
Part no.	size	mm	g	pc/box
80923	1/4"(F) x3/8"(M)	26	18	25

1/4"DR. Magnetic bit holder



81022M		<i>l</i>		
Part no.	size	mm	g	pc/box
81022M	1/4"DR.x1/4"inhex	25	14	50

1/4"DR. Magnetic socket pick-up



81225		<i>l</i>		
Part no.	size	mm	g	pc/box
81225	1/4"DR.	25	16	50

1/4"DR. Spinner



8145		<i>l</i>		
Part no.	size	mm	g	pc/box
8145	1/4"DR. with 1/4"DR.(F)	150-6"	88	10

1/4"DR. Ratchet spinner



8149		<i>l</i>		
Part no.	size	mm	g	pc/box
8149	1/4"DR	193	160	10

1/4"DR. Plastic hanger



PI8022		<i>l</i>	
Part no.	size	mm	g
PI8022	1/4"DR.	140	18

1/4"DR. Speed handle



8152370A		<i>l</i>		
Part no.	size	mm	g	pc/box
8152370A	1/4"DR	370	310	5

1/4"DR. Plastic hanger



PI8032		<i>l</i>	
Part no.	size	mm	g
PI8032	1/4"DR.	102	8

1/4"DR. Socket rail



8192		<i>l</i>	
Part no.	size	mm	g
819210	10	160	25
819212	12	200	32
819230	30	560	122

1/4"DR. Plastic hanger



8162		<i>l</i>	
Part no.	size	mm	g
8162	1/4"DR.	61	3

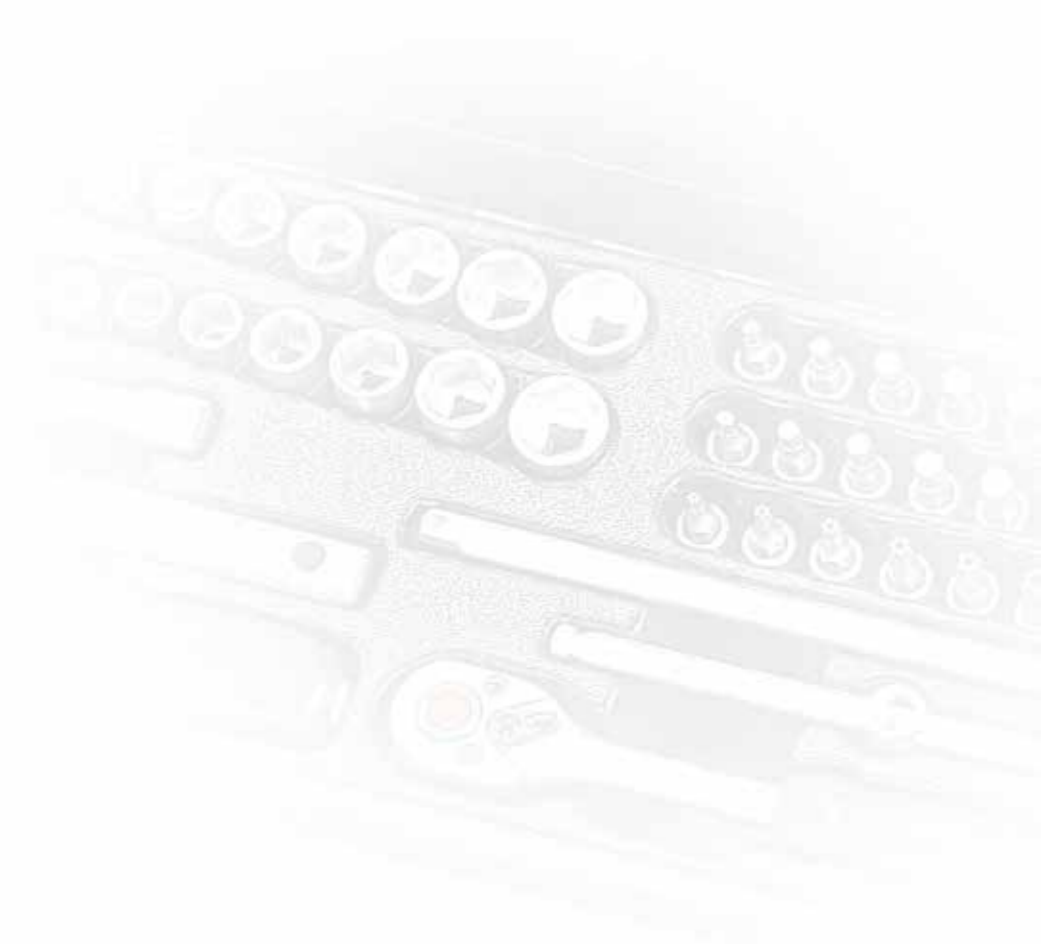

9pc 3/8"DR. 6pt. Flank socket set



3093		40/22.0/23.0/1.7'		550g
		9pc	9; 10; 11; 12; 13; 14; 15; 17; 19 mm	

12pc 3/8"DR. Socket set

NEW



3128		36/17.0/18.0/1.2'		472g
		12pc	8; 9; 10; 11; 12; 13; 14; 15; 16; 17; 18; 19 mm	

3128-9		36/17.0/18.0/1.2'		472g
		12pc	8; 9; 10; 11; 12; 13; 14; 15; 16; 17; 18; 19 mm	

13pc 3/8"DR. Socket set

NEW



3131		36/23.8/24.8/1.6'		660g
		13pc	8; 10; 12; 13; 14; 15; 16; 17; 18; 19; 21; 22; 24 mm	

3131-9		36/23.8/24.8/1.6'		660g
		13pc	8; 10; 12; 13; 14; 15; 16; 17; 18; 19; 21; 22; 24 mm	

8pc 3/8"DR. 6pt. Flank deep socket set



3082		24/15.8/16.8/1.4'		660g
		8pc	8; 10; 12; 13; 14; 16; 17; 19 mm (63mmL)	

12pc 3/8"DR. Deep socket set

NEW



3128D		12/11.1/12.1/0.67'		914g
		12pc	8; 9; 10; 11; 12; 13; 14; 15; 16; 17; 18; 19 mm (63mmL)	

3128D-9		12/11.1/12.1/0.67'		914g
		12pc	8; 9; 10; 11; 12; 13; 14; 15; 16; 17; 18; 19 mm (63mmL)	

12pc 3/8"DR. 6pt. Flank deep socket set



3121		6/7.2/8.2/0.9'		1200g
		12pc	8; 10; 11; 12; 13; 14; 15; 16; 17; 18; 19; 22 mm (63mmL)	

15pc 1/4" & 3/8" Deep socket set



3151		20/18.4/19.4/1.2'		920g
		6pc	1/4"DR. 8; 9; 10; 11; 12; 13 mm (50mmL)	
		9pc	3/8"DR. 8; 10; 11; 12; 13; 14; 15; 17; 19 mm (63mmL)	

3151-5		20/18.4/19.4/1.2'		920g
		6pc	1/4"DR. 8; 9; 10; 11; 12; 13 mm (50mmL)	
		9pc	3/8"DR. 8; 10; 11; 12; 13; 14; 15; 17; 19 mm (63mmL)	

9pc 3/8"DR. 6pt. Flank socket set (SAE)

NEW



3098		40/14.0/15.0/1.7'		332g
		9pc	1/4"; 5/16"; 3/8"; 7/16"; 1/2"; 9/16"; 5/8"; 11/16"; 3/4"	

11pc 3/8"DR. Socket set (SAE)



3113S		20/8.3/9.3/1'		416g
		11pc	1/4"; 5/16"; 3/8"; 7/16"; 1/2"; 9/16"; 5/8"; 11/16"; 3/4"; 13/16"; 7/8"	

3113S-5		20/8.3/9.3/1'		416g
		11pc	1/4"; 5/16"; 3/8"; 7/16"; 1/2"; 9/16"; 5/8"; 11/16"; 3/4"; 13/16"; 7/8"	

8pc 3/8"DR. 6pt. Flank deep socket set (SAE)



3082S		24/15.8/16.8/1.4'		660g
		8pc	5/16"; 3/8"; 7/16"; 1/2"; 9/16"; 5/8"; 11/16"; 3/4" (63mmL)	

19pc 3/8"DR. 6pt. Flank socket set (SAE)



3193 6/10.6/11.6/0.9' Δ 1760g

	11pc	1/4"; 5/16"; 3/8"; 7/16"; 1/2"; 9/16"; 5/8"; 11/16"; 3/4"; 13/16"; 7/8"
	8pc	5/16"; 3/8"; 7/16"; 1/2"; 9/16"; 5/8"; 11/16"; 3/4" (63mmL)

6pc 3/8"DR. Star socket set



3064 80/15.8/16.8/1.4' Δ 197g

	6pc	E6; E7; E8; E10; E12; E14
--	-----	---------------------------

7pc 1/4" & 3/8" Star socket set



3074 80/14.6/15.6/1.4' Δ 182g

	3pc	1/4"DR. E6; E7; E8
	4pc	3/8"DR. E10; E12; E14; E16

10pc 1/4" & 3/8" Star socket set



3101 60/15.5/16.5/1.4' Δ 258g

	5pc	1/4"DR. E4; E5; E6; E7; E8
	5pc	3/8"DR. E10; E12; E14; E16; E18

12pc 3/8"DR. Star socket set



3127 36/14.4/15.4/1.2' Δ 400g

	12pc	E4; E5; E6; E7; E8; E10; E11; E12; E14; E16; E18; E20
--	------	---

11pc 3/8"DR. Star deep socket set



3112 24/15.6/16.6/1.9' Δ 650g

	11pc	E4; E5; E6; E7 (55mmL) E8; E10; E11; E12; E14; E16; E18 (63mmL)
--	------	--

12pc 3/8"DR. Spline socket set



3122Q 36/21.2/22.2/1.3' Δ 588g

	12pc	8; 10; 11; 12; 13; 14; 15; 16; 17; 18; 19; 22 mm
--	------	--

10pc 3/8"DR. Spline deep socket set



3108Q 24/20.5/21.5/0.9' Δ 854g

	10pc	8; 10; 11; 12; 13; 14; 15; 16; 17; 19 mm (63mmL)
--	------	--

10pc 3/8"DR. Universal socket set



3105R 24/19.4/20.4/1.3' Δ 762g

	10pc	10; 11; 12; 13; 14; 15; 16; 17; 18; 19 mm (42mmL)
--	------	---

10pc 3/8"DR. Universal deep socket set







3103R 12/13.3/14.3/0.67' Δ 1106g

	10pc	10; 11; 12; 13; 14; 15; 16; 17; 18; 19 mm (85mmL)
--	------	---

7pc 3/8"DR. Universal socket set (SAE)







30710S  20/12.0/13.0/1.2'  600g

		7pc	3/8"; 7/16"; 1/2"; 9/16"; 5/8"; 11/16"; 3/4" (42mmL)
---	---	-----	--

7pc 3/8"DR. Universal deep socket set (SAE)











3077S  20/16.4/17.4/1.3'  820g

		7pc	3/8"; 7/16"; 1/2"; 9/16"; 5/8"; 11/16"; 3/4" (85mmL)
---	---	-----	--

22pc 3/8"DR. Universal socket set







3224  6/17.2/18.2/0.9'  2860g



		10pc	10; 11; 12; 13; 14; 15; 16; 17; 18; 19 mm (42mmL)
		10pc	10; 11; 12; 13; 14; 15; 16; 17; 18; 19 mm (85mmL)
		2pc	Magnetic spark plug 16; 20.6 mm



7pc 3/8"DR. Hex socket bit set



3075  48/18.1/19.1/1.4'  377g



		7pc	3; 4; 5; 6; 7; 8; 10 mm (50mmL)
---	---	-----	---------------------------------





3075S  48/18.1/19.1/1.4'  377g

		7pc	1/8"; 5/32"; 3/16"; 7/32"; 1/4"; 5/16"; 3/8" (50mmL)
---	---	-----	--

9pc 3/8" & 1/2" Hex socket bit set







3099  24/18.7/19.7/0.9'  780g

		6pc	3/8"DR. 4; 5; 6; 7; 8; 10 mm (50mmL)
		3pc	1/2"DR. 12mm (55mmL); 14mm (65mmL); 17mm (70mmL)

7pc 3/8"DR. Hex ball point socket bit set







3076  40/16.5/17.5/1.6'  413g

		7pc	3; 4; 5; 6; 7; 8; 10 mm (62mmL)
---	---	-----	---------------------------------

7pc 3/8"DR. Hex ball point long socket bit set







3076L  40/21.5/22.5/1.8'  538g

		7pc	3; 4; 5; 6; 7; 8; 10 mm (100mmL)
---	---	-----	----------------------------------

8pc 3/8"DR. Star socket bit set







3086  60/23.3/24.3/1.7'  388g

		8pc	T20; T25; T27; T30; T40; T45; T50; T55 (50mmL)
---	---	-----	--

8pc 3/8"DR. Star tamperproof socket bit set



3086T  60/23.3/24.3/1.7'  388g

		8pc	T-20H; T-25H; T-27H; T-30H; T-40H; T-45H; T-50H; T-55H (50mmL)
---	---	-----	--

6pc 3/8"DR. Spline socket bit set



3068 40/14.2/15.2/0.9' 356g

	6pc	M5; M6; M8; M9; M10; M12 (50mmL)
--	-----	----------------------------------

9pc 3/8" & 1/2" Spline socket bit set



30911 24/20.4/21.4/0.9' 850g

	5pc	3/8"DR. M5; M6; M8; M9; M10 (50mmL)
	3pc	1/2"DR. M12; M14; M16 (55mmL)
	1pc	1/2"DR. M16 (55mmL)

7pc 3/8" & 1/2" Ribe socket bit set



3078A 20/15.2/16.2/1.2' 762g

	5pc	3/8"DR. M6; M7; M8; M9; M10 (90mmL)
	2pc	1/2"DR. M12; M14 (100mmL)

9pc 3/8" & 1/2" Ribe socket bit set



30912 24/23.2/24.2/0.9' 968g

	6pc	3/8"DR. M5; M6; M7; M8; M9; M10 (90mmL)
	3pc	1/2"DR. M12; M13; M14 (100mmL)

9pc 1/4" & 3/8" Five-sided star tamperproof socket bit set



3095 30/7.0/8.0/0.9' 233g

	7pc	1/4"DR. TS10; TS15; TS20; TS25; TS27; TS30; TS40 (32mmL)
	2pc	3/8"DR. TS45; TS50 (50mmL)

3pc 3/8"DR. Extension set

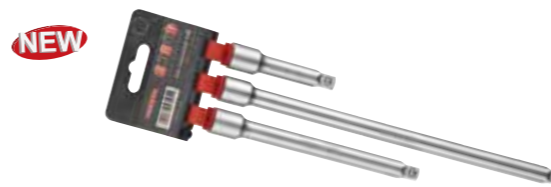

3039 40/18.6/19.6/0.51' 470g

	3pc	3"(75mm); 6"(150mm); 10"(250mm)
--	-----	---------------------------------

3pc 3/8"DR. Wobble extension set

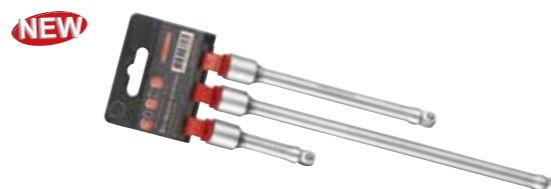

3039W 40/15.3/16.3/0.51' 382g

	3pc	Wobble extension 3"(75mm); 6"(150mm); 10"(250mm)
--	-----	---

5pc 3/8"DR. Accessory set



3051 20/17.5/18.5/1.3' 875g

	2pc	Spark plug 16; 20.6 mm
	1pc	QR flexible pear ratchet handle 45teeth (802313)
	2pc	1.75"(44mm); 3"(75mm)

3051M 20/17.5/18.5/1.3' 875g

Changed items

	2pc	Magnetic spark plug 16; 20.6 mm
--	-----	---------------------------------

7pc 3/8"DR. Ratchet handle set



30712 6/14.7/15.7/0.9' 2450g

	3pc	Spark plug 16; 18; 20.6 mm
	1pc	20-110 Nm, 365mmL (6473365)
	1pc	QR pear ratchet handle 24teeth (80232)
	1pc	QR stubby ratchet handle 30teeth (802319)
	1pc	Flexible round ratchet handle 72teeth (802323)

17pc 1/4" & 3/8" Star set



3171 25/10.3/11.3/0.64' 412g

	3pc	1/4"DR. E6; E7; E8
	4pc	3/8"DR. E10; E12; E14; E16
	9pc	5/16" T10; T15; T20; T25; T30; T40; T45; T50; T55 (30mmL)
	1pc	3/8"DR.x5/16"(F)

3171T 25/10.3/11.3/0.64' 412g

Changed items

	9pc	5/16" T-10H; T-15H; T-20H; T-25H; T-30H; T-40H; T-45H; T-50H; T-55H (30mmL)
--	-----	---

21pc 3/8"DR. Star set

NEW



3215

10/10.8/11.8/1.2' 1078g

	12pc	E4; E5; E6; E7; E8; E10; E11; E12; E14; E16; E18; E20
	9pc	T20; T25; T27; T30; T40; T45; T50; T55; T60 (50mmL)

52pc 1/4" & 3/8" & 1/2" Star set

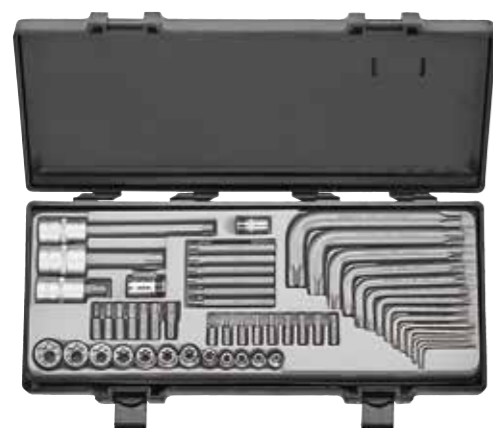

3521

6/18.0/19.0/0.9' 3000g

	5pc	1/4"DR. E4; E5; E6; E7; E8
	7pc	3/8"DR. E10; E11; E12; E14; E16; E18; E20
	7pc	5/16" T20; T25; T30; T40; T45; T50; T55 (30mmL)
	1pc	1/2"DR. T60 (55mmL)
	6pc	5/16" T20; T25; T30; T40; T45; T50 (70mmL)
	2pc	1/2"DR. T70 (100mmL); T55 (140mmL)
	9pc	1/4" T-8H; T-10H; T-15H; T-20H; T-25H; T-27H; T-30H; T-35H; T-40H (25mmL)
	2pc	1/4"DR.x1/4"(F); 3/8"DR.x5/16"(F)
	13pc	T9; T10; T15; T20; T25; T27; T30; T40; T45; T50; T55; T60; T70

38pc 3/8"DR. Star set

NEW



3382

6/13.6/14.6/0.9' 2260g

	12pc	E4; E5; E6; E7; E8; E10; E11; E12; E14; E16; E18; E20
	11pc	E4; E5; E6; E7 (55mmL) E8; E10; E11; E12; E14; E16; E18 (63mmL)
	6pc	T30; T40; T45; T50; T55; T60 (50mmL)
	9pc	T10; T15; T20; T25; T27; T30; T40; T45; T50 (5098XL)

3382T

6/13.4/14.4/0.9' 2233g

Changed items	9pc	T-10H; T-15H; T-20H; T-25H; T-27H; T-30H; T-40H; T-45H; T-50H (5098XLT)
---------------	-----	---

14pc 3/8"DR. Go-through spline socket combination set

NEW



3143

10/12.2/13.2/1.2' 1222g

	10pc	Go-through 10; 11; 12; 13; 14; 15; 16; 17; 18; 19 mm
	1pc	Go-through reversible ratchet handle 72teeth (8023GTA)
	1pc	Go-through 3"(75mm)
	2pc	Adapter with push QR 3/8"DR.; 1/4"DR.

23pc 3/8"DR. Socket combination set



3232

10/18.5/19.5/1' 1850g

	17pc	6; 7; 8; 9; 10; 11; 12; 13; 14; 15; 16; 17; 18; 19; 20; 21; 22 mm
	1pc	Round ratchet handle 72teeth (80239)
	3pc	3"(75mm); 6"(150mm); 9"(225mm)
	1pc	3/8"
	1pc	1/2"(F)x3/8"(M) for extension

3232-7

10/18.5/19.5/1' 1850g

Changed items	17pc	6; 7; 8; 9; 10; 11; 12; 13; 14; 15; 16; 17; 18; 19; 20; 21; 22 mm
---------------	------	---

3232-9

10/18.5/19.5/1' 1850g

Changed items	17pc	6; 7; 8; 9; 10; 11; 12; 13; 14; 15; 16; 17; 18; 19; 20; 21; 22 mm
---------------	------	---

24pc 3/8"DR. Socket combination set

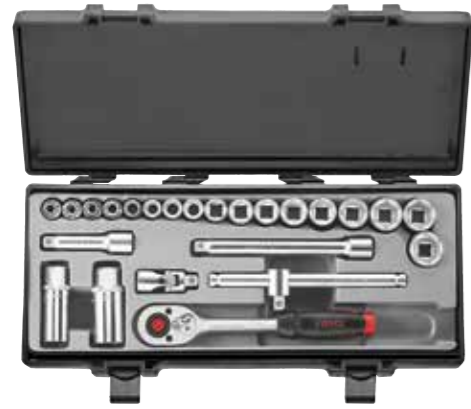

3251 6/13.9/14.9/0.9' 2320g

	17pc	6; 7; 8; 9; 10; 11; 12; 13; 14; 15; 16; 17; 18; 19; 20; 21; 22 mm
	2pc	Spark plug 16; 20.6 mm
	1pc	QR pear ratchet handle 24teeth (80232)
	2pc	3"(75mm); 6"(150mm)
	1pc	6.5"(165mm)
	1pc	3/8"

3251-5 6/14.0/15.0/0.9' 2330g

Changed items

	17pc	6; 7; 8; 9; 10; 11; 12; 13; 14; 15; 16; 17; 18; 19; 20; 21; 22 mm
--	------	---

3251-9 6/14.5/15.5/0.9' 2420g

Changed items

	17pc	6; 7; 8; 9; 10; 11; 12; 13; 14; 15; 16; 17; 18; 19; 20; 21; 22 mm
--	------	---

3251Q 6/14.3/15.3/0.9' 2380g

Changed items

	17pc	Spline socket 6; 7; 8; 9; 10; 11; 12; 13; 14; 15; 16; 17; 18; 19; 20; 21; 22 mm
--	------	---

3251-72 6/16.4/17.4/0.9' 2730g

Changed items

	1pc	Round ratchet handle 72teeth (80239)
--	-----	--------------------------------------

3251-72-5 6/16.4/17.4/0.9' 2730g

Changed items

	17pc	6; 7; 8; 9; 10; 11; 12; 13; 14; 15; 16; 17; 18; 19; 20; 21; 22 mm
	1pc	Round ratchet handle 72teeth (80239)

3251-5-18 6/16.4/17.4/0.9' 2730g

Changed items

	17pc	6; 7; 8; 9; 10; 11; 12; 13; 14; 15; 16; 17; 18; 19; 20; 21; 22 mm
	1pc	QR flexible pear ratchet handle 30teeth (802318)

26pc 3/8"DR. Socket combination set



3261 4/10.0/11.0/0.85' 2500g

	18pc	6; 7; 8; 9; 10; 11; 12; 13; 14; 15; 16; 17; 18; 19; 20; 21; 22; 24 mm
	2pc	Spark plug 16; 20.6 mm
	1pc	QR pear ratchet handle 24teeth (80232)
	3pc	1.75"(44mm); 3"(75mm); 6"(150mm)
	1pc	3/8"
	1pc	1/2"(F)x3/8"(M) for extension

3261-7 4/10.0/11.0/0.85' 2500g

Changed items

	18pc	6; 7; 8; 9; 10; 11; 12; 13; 14; 15; 16; 17; 18; 19; 20; 21; 22; 24 mm
--	------	---

3261-9 4/10.0/11.0/0.85' 2500g

Changed items

	18pc	6; 7; 8; 9; 10; 11; 12; 13; 14; 15; 16; 17; 18; 19; 20; 21; 22; 24 mm
--	------	---

30pc 3/8"DR. 6pt. Flank socket combination set



3302 10/21.7/22.7/1.3' 2170g

	18pc	6; 7; 8; 9; 10; 11; 12; 13; 14; 15; 16; 17; 18; 19; 20; 21; 22; 24 mm
	6pc	8; 9; 10; 12; 13; 14 mm (63mmL)
	2pc	Spark plug 16; 20.6 mm
	1pc	QR thin pear ratchet handle 24teeth (80233)
	2pc	3"(75mm); 6"(150mm)
	1pc	3/8"

35pc 3/8"DR. Socket combination set

NEW



3352 6/22.85/23.85/1' 3808g

	18pc	6; 7; 8; 9; 10; 11; 12; 13; 14; 15; 16; 17; 18; 19; 20; 21; 22; 24 mm
	12pc	8; 9; 10; 11; 12; 13; 14; 15; 16; 17; 18; 19 mm (63mmL)
	1pc	QR pear ratchet handle 72teeth (80238)
	2pc	3"(75mm); 6"(150mm)
	1pc	6.5"(165mm)
	1pc	3/8"

3352Q 6/22.85/23.85/1' 3808g

Changed items

	18pc	Spline socket 6; 7; 8; 9; 10; 11; 12; 13; 14; 15; 16; 17; 18; 19; 20; 21; 22; 24 mm
	12pc	Spline socket 8; 9; 10; 11; 12; 13; 14; 15; 16; 17; 18; 19 mm (63mmL)

36pc 3/8"DR. Combination set



3361 6/18.2/19.2/0.9' 3030g

	17pc	6; 7; 8; 9; 10; 11; 12; 13; 14; 15; 16; 17; 18; 19; 20; 21; 22 mm
	2pc	Spark plug 16; 20.6 mm
	1pc	Round ratchet handle 72teeth (80239)
	3pc	3"(75mm); 6"(150mm); 9"(225mm)
	1pc	3/8"
	1pc	1/2"(F)x3/8"(M) for extension
	11pc	7; 8; 9; 10; 11; 12; 13; 14; 15; 16; 17 mm

3361-7 6/18.2/19.2/0.9' 3030g

Changed items

	17pc	6; 7; 8; 9; 10; 11; 12; 13; 14; 15; 16; 17; 18; 19; 20; 21; 22 mm
--	------	---

3361-9 6/18.2/19.2/0.9' 3030g

Changed items

	17pc	6; 7; 8; 9; 10; 11; 12; 13; 14; 15; 16; 17; 18; 19; 20; 21; 22 mm
--	------	---

3361-8 6/18.5/19.5/0.9' 3080g

Changed items

	1pc	QR pear ratchet handle 72teeth (80238)
--	-----	--

44pc 3/8"DR. 6pt. Flank & star socket combination set

NEW



3443		4/13.4/14.4/1'		3346g
	19pc	6; 7; 8; 9; 10; 11; 12; 13; 14; 15; 16; 17; 18; 19; 20; 21; 22; 23; 24 mm		
	12pc	8; 10; 11; 12; 13; 14; 15; 16; 17; 18; 19; 21 mm (63mmL)		
	8pc	E8; E10; E11; E12; E14; E16; E18; E20		
	1pc	QR thin pear ratchet handle 24teeth (80233)		
	2pc	3"(75mm); 6"(150mm)		
	1pc	6.5"(165mm)		
	1pc	3/8"		
3443-4		4/13.4/14.4/1'		3346g
Changed items				
	1pc	QR thin pear ratchet handle 24teeth (80234)		
3443-8		4/13.4/14.4/1'		3346g
Changed items				
	1pc	QR pear ratchet handle 72teeth (80238)		
3443-27		4/13.4/14.4/1'		3346g
Changed items				
	1pc	QR curved-shank ratchet handle 36teeth (802327)		

61pc 3/8"DR. Socket combination set



3611		4/16.5/17.5/1'		4130g
	18pc	6; 7; 8; 9; 10; 11; 12; 13; 14; 15; 16; 17; 18; 19; 20; 21; 22; 24 mm		
	9pc	8; 10; 11; 12; 13; 14; 15; 17; 19 mm (63mmL)		
	2pc	Spark plug 16; 20.6 mm		
	3pc	PH.1; PH.2; PH.3 (50mmL)		
	3pc	PZ.1; PZ.2; PZ.3 (50mmL)		
	3pc	5.5; 6.5; 8 mm (50mmL)		
	7pc	3; 4; 5; 6; 7; 8; 10 mm (50mmL)		
	10pc	T10; T15; T20; T25; T27; T30; T40; T45; T50; T55 (50mmL)		
	1pc	QR pear ratchet handle 24teeth (80232)		
	3pc	3"(75mm); 6"(150mm); 10"(250mm)		
	1pc	3/8"		
	1pc	1/2"(F)x3/8"(M) for extension		
3611-5		4/16.5/17.5/1'		4130g
Changed items				
	18pc	6; 7; 8; 9; 10; 11; 12; 13; 14; 15; 16; 17; 18; 19; 20; 21; 22; 24 mm		
	9pc	8; 10; 11; 12; 13; 14; 15; 17; 19 mm (63mmL)		

51pc 3/8"DR. 6pt. Flank socket combination set



3511		4/9.3/10.3/0.85'		2334g
	17pc	6; 7; 8; 9; 10; 11; 12; 13; 14; 15; 16; 17; 18; 19; 20; 21; 22 mm		
	2pc	Spark plug 16; 20.6 mm		
	4pc	1/4" PH.0; PH.1; PH.2; PH.3 (30mmL)		
	3pc	1/4" PZ.1; PZ.2; PZ.3 (30mmL)		
	3pc	1/4" 4; 5.5; 6.5 mm (30mmL)		
	7pc	1/4" 2; 3; 4; 5; 6; 7; 8 mm (30mmL)		
	7pc	1/4" T10; T15; T20; T25; T27; T30; T40 (30mmL)		
	1pc	QR thin pear ratchet handle 24teeth (80233)		
	2pc	3"(75mm); 6"(150mm)		
	1pc	3/8"		
	1pc	3/8"(F)x1/4"(M)		
	2pc	1/4"DR.x1/4"(F); 3/8"DR.x1/4"(F)		
	1pc	6"(150mm) with 1/4"DR.(F)		

61pc 3/8"DR. 6pt. Flank & star socket combination set

NEW



3612		3/16.3/17.3/0.8'		5416g
	17pc	6; 7; 8; 9; 10; 11; 12; 13; 14; 15; 16; 17; 18; 19; 20; 21; 22 mm		
	11pc	8; 10; 11; 12; 13; 14; 15; 16; 17; 18; 19 mm (63mmL)		
	12pc	E4; E5; E6; E7; E8; E10; E11; E12; E14; E16; E18; E20		
	7pc	3; 4; 5; 6; 7; 8; 10 mm (50mmL)		
	8pc	T20; T25; T27; T30; T40; T45; T50; T55 (50mmL)		
	1pc	QR pear ratchet handle 72teeth (80238)		
	2pc	3"(75mm); 6"(150mm)		
	1pc	Wobble extension 10"(250mm)		
	1pc	6.5"(165mm)		
	1pc	3/8"		

68pc 3/8"DR. 6pt. Flank & star socket combination set

NEW



3681 3/13.2/14.2/1.2' 4410g

	19pc	6; 7; 8; 9; 10; 11; 12; 13; 14; 15; 16; 17; 18; 19; 20; 21; 22; 23; 24 mm
	8pc	E8; E10; E11; E12; E14; E16; E18; E20
	3pc	PH.1; PH.2; PH.3 (50mmL)
	1pc	PZ.2 (50mmL)
	4pc	4; 5.5; 6.5; 8 mm (50mmL)
	8pc	4; 5; 6; 7; 8; 9; 10; 12 mm (50mmL)
	9pc	T20; T25; T27; T30; T40; T45; T50; T55; T60 (50mmL)
	5pc	T-20H; T-25H; T-27H; T-30H; T-40H (50mmL)
	6pc	M5; M6; M8; M9; M10; M12 (50mmL)
	1pc	QR thin pear ratchet handle 24teeth (80233)
	2pc	3"(75mm); 6"(150mm)
	1pc	6.5"(165mm)
	1pc	3/8"

3681-4 3/13.2/14.2/1.2' 4410g

Changed items

	1pc	QR thin pear ratchet handle 24teeth (80234)
--	-----	---

3681-8 3/13.2/14.2/1.2' 4410g

Changed items

	1pc	QR pear ratchet handle 72teeth (80238)
--	-----	--

3681-27 3/13.2/14.2/1.2' 4410g

Changed items

	1pc	QR curved-shank ratchet handle 36teeth (802327)
--	-----	---

21pc 3/8"DR. 6pt. Flank socket combination set (SAE)



3212 6/12.2/13.2/0.9' 2030g

	13pc	1/4"; 5/16"; 3/8"; 7/16"; 1/2"; 9/16"; 19/32"; 5/8"; 11/16"; 3/4"; 25/32"; 13/16"; 7/8"
	2pc	Spark plug 16mm (5/8"); 20.6mm (13/16")
	1pc	QR pear ratchet handle 24teeth (80232)
	3pc	3"(75mm); 6"(150mm); 10"(250mm)
	1pc	6.5"(165mm)
	1pc	3/8"

32pc 3/8"DR. 6pt. Flank socket combination set (S&M)



3322 6/15.0/16.0/0.9' 2500g

	17pc	6; 7; 8; 9; 10; 11; 12; 13; 14; 15; 16; 17; 18; 19; 20; 21; 22 mm
	7pc	1/4"; 3/8"; 1/2"; 9/16"; 5/8"; 11/16"; 13/16"
	2pc	Spark plug 16mm (5/8"); 20.6mm (13/16")
	1pc	Round ratchet handle 72teeth (802322)
	3pc	3"(75mm); 6"(150mm); 9"(225mm)
	1pc	3/8"
	1pc	1/2"(F)x3/8"(M) for extension

3322-15 6/15.0/16.0/0.9' 2500g

Changed items

	1pc	QR pear ratchet handle 30teeth (802315)
--	-----	---

3322-24 6/15.0/16.0/0.9' 2500g

Changed items

	1pc	QR pear ratchet handle 24teeth (80232)
--	-----	--

3322-23 6/15.0/16.0/0.9' 2500g

Changed items

	1pc	Flexible round ratchet handle 72teeth (802323)
--	-----	--

35pc 3/8"DR. Socket combination set (S&M)



3351 6/17.0/18.0/0.7' 2833g

	15pc	6; 7; 8; 9; 10; 11; 12; 13; 14; 15; 16; 17; 18; 19; 21 mm
	11pc	1/4"; 5/16"; 3/8"; 7/16"; 1/2"; 9/16"; 5/8"; 11/16"; 3/4"; 13/16"; 7/8"
	1pc	Spark plug 16mm (5/8")
	1pc	QR pear ratchet handle 24teeth (80232)
	3pc	3"(75mm); 6"(150mm); 9"(225mm)
	1pc	3/8"
	1pc	3/8"(F)x3/8"(M) for extension
	2pc	3/8"(F)x1/4"(M); 3/8"(F)x1/2"(M)

3351-5 6/17.0/18.0/0.7' 2833g

Changed items

	15pc	6; 7; 8; 9; 10; 11; 12; 13; 14; 15; 16; 17; 18; 19; 21 mm
	11pc	1/4"; 5/16"; 3/8"; 7/16"; 1/2"; 9/16"; 5/8"; 11/16"; 3/4"; 13/16"; 7/8"

36pc 3/8" 6pt. Flank socket combination set (S&M)

NEW



3362 6/23.0/24.0/1' 3830g

	17pc	6; 7; 8; 9; 10; 11; 12; 13; 14; 15; 16; 17; 18; 19; 20; 21; 22 mm
	11pc	1/4"; 5/16"; 3/8"; 7/16"; 1/2"; 9/16"; 5/8"; 11/16"; 3/4"; 13/16"; 7/8"
	2pc	Spark plug 16mm (5/8"); 20.6mm (13/16")
	1pc	QR pear ratchet handle 72teeth (80238)
	1pc	8.5"(215mm)
	2pc	3"(75mm); 6"(150mm)
	1pc	6.5"(165mm)
	1pc	3/8"

39pc 1/4" & 3/8" Socket combination set (S&M)



3391

6/13.6/14.6/0.7' 2270g

1/4"DR. Part

	9pc	4; 5; 6; 7; 8; 9; 10; 11; 12 mm
	9pc	3/16"; 7/32"; 1/4"; 9/32"; 5/16"; 11/32"; 3/8"; 7/16"; 1/2"
	1pc	6"(150mm) with 1/4"DR.(F)

3/8"DR. Part

	9pc	9; 10; 11; 12; 13; 14; 16; 17; 19 mm
	7pc	3/8"; 7/16"; 1/2"; 9/16"; 5/8"; 11/16"; 3/4"
	1pc	Spark plug 16mm (5/8")
	1pc	QR pear ratchet handle 24teeth (80232)
	1pc	3"(75mm)
	1pc	3/8"(F)x1/4"(M)

3391-5

6/13.6/14.6/0.7' 2270g

Changed items

	9pc	1/4"DR. 4; 5; 6; 7; 8; 9; 10; 11; 12 mm
	9pc	1/4"DR. 3/16"; 7/32"; 1/4"; 9/32"; 5/16"; 11/32"; 3/8"; 7/16"; 1/2"
	9pc	3/8"DR. 9; 10; 11; 12; 13; 14; 16; 17; 19 mm
	7pc	3/8"DR. 3/8"; 7/16"; 1/2"; 9/16"; 5/8"; 11/16"; 3/4"

45pc 3/8"DR. 6pt. Flank socket combination set (S&M)



3451

4/20.2/21.2/0.9' 5050g

	15pc	8; 9; 10; 11; 12; 13; 14; 15; 16; 17; 18; 19; 20; 21; 22 mm
	5pc	3/8"; 1/2"; 9/16"; 11/16"; 13/16"
	11pc	8; 9; 10; 11; 12; 13; 14; 16; 17; 19; 22 mm (63mmL)
	5pc	3/8"; 1/2"; 9/16"; 11/16"; 13/16" (63mmL)
	3pc	Spark plug 16mm (5/8"); 18mm; 20.6mm (13/16")
	1pc	QR pear ratchet handle 24teeth (802311)
	1pc	Bent 8"(200mm)
	2pc	3"(75mm); 6"(150mm)
	1pc	3/8"
	1pc	1/2"(F)x3/8"(M) for extension

43pc 1/4" & 3/8" 6pt. Flank socket combination set (S&M)

NEW



3431

6/22.5/23.5/1' 3745g

1/4"DR. Part

	7pc	4; 5; 6; 7; 8; 9; 10 mm
	7pc	3/16"; 7/32"; 1/4"; 9/32"; 5/16"; 11/32"; 3/8"
	1pc	Flexible round ratchet handle 72teeth (802223)
	2pc	Wobble extension 2"(50mm); 6"(150mm)

3/8"DR. Part

	10pc	10; 11; 12; 13; 14; 15; 16; 17; 18; 19 mm
	7pc	3/8"; 7/16"; 1/2"; 9/16"; 5/8"; 11/16"; 3/4"
	2pc	Spark plug 16mm (5/8"); 20.6mm (13/16")
	1pc	QR pear ratchet handle 72teeth (80238)
	1pc	8.5"(215mm)
	2pc	Wobble extension 3"(75mm); 6"(150mm)
	1pc	6.5"(165mm)
	1pc	3/8"
	1pc	3/8"(F)x1/4"(M)

55pc 3/8"DR. 6pt. Flank socket combination set (S&M)

NEW



3552

3/18.5/19.5/0.9' 6150g

	17pc	6; 7; 8; 9; 10; 11; 12; 13; 14; 15; 16; 17; 18; 19; 20; 21; 22 mm
	11pc	1/4"; 5/16"; 3/8"; 7/16"; 1/2"; 9/16"; 5/8"; 11/16"; 3/4"; 13/16"; 7/8"
	12pc	8; 9; 10; 11; 12; 13; 14; 15; 16; 17; 18; 19 mm (63mmL)
	8pc	5/16"; 3/8"; 7/16"; 1/2"; 9/16"; 5/8"; 11/16"; 3/4" (63mmL)
	1pc	QR pear ratchet handle 72teeth (80238)
	1pc	Flexible round ratchet handle 72teeth (802323)
	1pc	8.5"(215mm)
	2pc	3"(75mm); 10"(250mm)
	1pc	6.5"(165mm)
	1pc	3/8"

3/8"DR. Phillips socket bit



331		<i>l</i>		
Part no.	size	mm	g	pc/box
331501	PH.1	50	42	20
331502	PH.2	50	42	20
331503	PH.3	50	42	20
331504	PH.4	50	46	20

3/8"DR. Pozidriv socket bit



332		<i>l</i>		
Part no.	size	mm	g	pc/box
332501	PZ.1	50	50	20
332502	PZ.2	50	50	20
332503	PZ.3	50	52	20
332504	PZ.4	50	52	20

3/8"DR. Slotted socket bit



333		<i>l</i>		
Part no.	size	mm	g	pc/box
3335004	1.8x4	50	50	20
3335005	1.0x5	50	50	20
33350055	1.0x5.5	50	50	20
3335006	1.0x6	50	50	20
3335007	1.2x7	50	50	20
3335008	1.2x8	50	50	20

3/8"DR. Hex socket bit

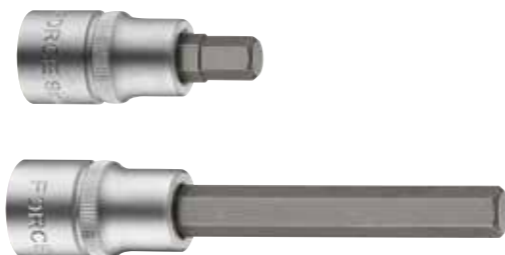

334		<i>l</i>		
Part no.	size	mm	g	pc/box
33405003	3	50	42	20
33405004	4	50	42	20
33405005	5	50	43	20
334050055	5.5	50	43	20
33405006	6	50	43	20
33405007	7	50	47	20
33405008	8	50	47	20
33405009	9	50	52	20
33405010	10	50	57	20
33405012	12	50	66	20
3340501.8	1/8"	50	42	20
3340505.32	5/32"	50	42	20
3340503.16	3/16"	50	43	20
3340507.32	7/32"	50	43	20
3340501.4	1/4"	50	45	20
3340505.16	5/16"	50	47	20
3340503.8	3/8"	50	57	20
3340507.16	7/16"	50	62	20
3340501.2	1/2"	50	66	20
33405504	4	55	48	10
33406005	5	60	50	10
33406506	6	65	52	10
33407007	7	70	62	10
33407508	8	75	64	10
33408510	10	85	86	10
33409012	12	90	108	10
3340555.32	5/32"	55	48	10
3340603.16	3/16"	60	50	10
3340657.32	7/32"	65	52	10
3340701.4	1/4"	70	62	10
3340805.16	5/16"	80	80	10
3340803.8	3/8"	80	86	10

334		<i>l</i>		
Part no.	size	mm	g	pc/box
33408004	4	80	56	10
33408005	5	80	58	10
33408006	6	80	58	10
33408007	7	80	66	10
33408008	8	80	66	10
33408009	9	80	86	10
33408010	10	80	80	10
33408012	12	80	104	10
33410008	8	100	75	10
33413010	10	130	120	10
33418005	5	180	75	10
33422006	6	220	93	10

3/8"DR. Hex ball point socket bit

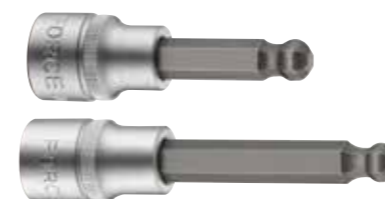

335		<i>l</i>		
Part no.	size	mm	g	pc/box
33506203	3	62	48	10
33506204	4	62	48	10
33506205	5	62	54	10
33506206	6	62	54	10
33506207	7	62	58	10
33506208	8	62	58	10
33506210	10	62	68	10
33510003	3	100	56	10
33510004	4	100	56	10
33510005	5	100	62	10
33510006	6	100	62	10
33510007	7	100	66	10
33510008	8	100	74	10
33510010	10	100	94	10

3/8"DR. Star socket bit



336		<i>l</i>		
Part no.	size	mm	g	pc/box
3365008	T8	50	50	20
3365009	T9	50	50	20
3365010	T10	50	50	20
3365015	T15	50	50	20
3365020	T20	50	50	20
3365025	T25	50	50	20
3365027	T27	50	50	20
3365030	T30	50	50	20
3365040	T40	50	50	20
3365045	T45	50	52	20
3365050	T50	50	52	20
3365055	T55	50	62	20
3365060	T60	50	72	20

3/8"DR. Star tamperproof socket bit



337		<i>l</i>		
Part no.	size	mm	g	pc/box
3375008	T-8H	50	42	20
3375010	T-10H	50	42	20
3375015	T-15H	50	42	20
3375020	T-20H	50	42	20
3375025	T-25H	50	42	20
3375027	T-27H	50	42	20
3375030	T-30H	50	42	20
3375035	T-35H	50	42	20
3375040	T-40H	50	42	20
3375045	T-45H	50	46	20
3375050	T-50H	50	47	20
3375055	T-55H	50	55	20
3375060	T-60H	50	60	20

3/8"DR. Spline socket bit



338		<i>l</i>		
Part no.	size	mm	g	pc/box
3385005	M5	50	50	20
3385006	M6	50	50	20
3385008	M8	50	52	20
3385009	M9	50	54	20
3385010	M10	50	54	20
3385012	M12	50	56	20
3388808	M8	88	68	10
3388909	M9	89	86	10
3388910	M10	89	86	10

3/8"DR. Ribe socket bit



339		<i>l</i>		
Part no.	size	mm	g	pc/box
33905007	M7	50	50	20
33905010	M10	50	55	20
33909005	M5	90	58	10
33909006	M6	90	60	10
33909007	M7	90	63	10
33909008	M8	90	64	10
33909009	M9	90	81	10
33909010	M10	90	83	10
33920007	M7	200	102	10
33924008	M8	240	129	10

3/8"DR. Five-sided star tamperproof socket bit



33F		<i>l</i>		
Part no.	size	mm	g	pc/box
33F5045	TS45	50	52	20
33F5050	TS50	50	52	20

3/8"DR. 6pt. Flank socket



535		<i>l</i>		
Part no.	size	mm	g	pc/box
53506	6	28	22	20
53507	7	28	23	20
53508	8	28	24	20
53509	9	28	24	20
53510	10	28	24	20
53511	11	28	25	20
53512	12	28	25	20
53513	13	28	28	20
53514	14	30	36	20
53515	15	30	44	20
53516	16	30	44	20
53517	17	30	47	20
53518	18	30	47	20
53519	19	30	55	20
53520	20	30	66	20
53521	21	30	66	20
53522	22	32	74	20
53523	23	32	74	20
53524	24	32	77	20

535		<i>l</i>		
Part no.	size	mm	g	pc/box
5351.4	1/4"	28	23	20
5355.16	5/16"	28	24	20
5353.8	3/8"	28	25	20
5357.16	7/16"	28	28	20
5351.2	1/2"	28	32	20
5359.16	9/16"	30	38	20
53519.32	19/32"	30	44	20
5355.8	5/8"	30	44	20
53511.16	11/16"	30	47	20
5353.4	3/4"	30	55	20
53525.32	25/32"	30	71	20
53513.16	13/16"	30	71	20
5357.8	7/8"	32	72	20
53515.16	15/16"	32	72	20

3/8"DR. 6pt. Flank deep socket



53546		<i>l</i>		
Part no.	size	mm	g	pc/box
5354608	8	46	29	20
5354610	10	46	34	20
5354612	12	46	38	20
5354613	13	46	43	20
5354614	14	46	54	20

53563		<i>l</i>		
Part no.	size	mm	g	pc/box
5356306	6	63	34	20
5356307	7	63	39	20
5356308	8	63	33	20
5356309	9	63	42	20
5356310	10	63	46	20
5356311	11	63	50	20
5356312	12	63	51	20
5356313	13	63	60	20
5356314	14	63	74	20
5356315	15	63	90	20

53563		<i>l</i>		
Part no.	size	mm	g	pc/box
5356316	16	63	86	20
5356317	17	63	102	10
5356318	18	63	94	10
5356319	19	63	125	10
5356320	20	63	141	10
5356321	21	63	129	10
5356322	22	63	150	10
5356323	23	63	151	10
5356324	24	63	152	10
535635.16	5/16"	63	33	20
535633.8	3/8"	63	46	20
535637.16	7/16"	63	50	20
535631.2	1/2"	63	51	20
535639.16	9/16"	63	74	20
535635.8	5/8"	63	86	20
5356311.16	11/16"	63	102	10
535633.4	3/4"	63	125	10
5356313.16	13/16"	63	129	10
535637.8	7/8"	63	150	10

3/8"DR. Star socket



536		<i>l</i>		
Part no.	size	mm	g	pc/box
53604	E4	28	22	20
53605	E5	28	23	20
53606	E6	28	23	20
53607	E7	28	23	20
53608	E8	28	23	20
53610	E10	28	24	20
53611	E11	28	25	20
53612	E12	28	26	20
53614	E14	28	27	20
53616	E16	28	30	20
53618	E18	28	36	20
53620	E20	28	46	20

3/8"DR. Star deep socket



536		<i>l</i>		
Part no.	size	mm	g	pc/box
5365504	E4	55	26	20
5365505	E5	55	29	20
5365506	E6	55	30	20
5365507	E7	55	34	20
5366308	E8	63	40	20
5366310	E10	63	45	20
5366311	E11	63	53	20
5366312	E12	63	57	20
5366314	E14	63	66	20
5366316	E16	63	78	20
5366318	E18	63	97	20

537		<i>l</i>		
Part no.	size	mm	g	pc/box
53721	21	30	66	20
53722	22	32	74	20
53724	24	32	77	20
5371.4	1/4"	28	23	20
5375.16	5/16"	28	24	20
5373.8	3/8"	28	25	20
5377.16	7/16"	28	28	20
5371.2	1/2"	28	32	20
5379.16	9/16"	30	38	20
53719.32	19/32"	30	44	20
5375.8	5/8"	30	44	20
53711.16	11/16"	30	47	20
5373.4	3/4"	30	55	20
53725.32	25/32"	30	71	20
53713.16	13/16"	30	71	20
5377.8	7/8"	32	72	20

3/8"DR. Surface drive socket



537		<i>l</i>		
Part no.	size	mm	g	pc/box
53706	6	28	22	20
53707	7	28	23	20
53708	8	28	24	20
53709	9	28	24	20
53710	10	28	24	20
53711	11	28	25	20
53712	12	28	25	20
53713	13	28	28	20
53714	14	30	36	20
53715	15	30	44	20
53716	16	30	44	20
53717	17	30	47	20
53718	18	30	47	20
53719	19	30	55	20
53720	20	30	66	20

3/8"DR. Surface drive deep socket



53763		<i>l</i>		
Part no.	size	mm	g	pc/box
5376306	6	63	33	20
5376307	7	63	36	20
5376308	8	63	40	20
5376310	10	63	45	20
5376311	11	63	53	20
5376312	12	63	57	20
5376313	13	63	61	20
5376314	14	63	66	20
5376315	15	63	70	20
5376316	16	63	79	20
5376317	17	63	78	10
5376318	18	63	94	10
5376319	19	63	97	10
5376320	20	63	142	10
5376321	21	63	132	10
5376322	22	63	149	10

3/8"DR. 12pt. Flank socket



539		<i>l</i>		
Part no.	size	mm	g	pc/box
53906	6	28	23	20
53907	7	28	24	20
53908	8	28	24	20
53909	9	28	24	20
53910	10	28	24	20
53911	11	28	24	20
53912	12	28	24	20
53913	13	28	27	20
53914	14	30	36	20
53915	15	30	44	20
53916	16	30	44	20
53917	17	30	47	20
53918	18	30	47	20
53919	19	30	55	20
53920	20	30	66	20
53921	21	30	66	20
53922	22	32	74	20
53923	23	32	72	20
53924	24	32	77	20
5391.4	1/4"	28	23	20
5395.16	5/16"	28	24	20
5393.8	3/8"	28	25	20
5397.16	7/16"	28	28	20
5391.2	1/2"	28	32	20
5399.16	9/16"	30	38	20
53919.32	19/32"	30	44	20
5395.8	5/8"	30	44	20
53911.16	11/16"	30	47	20
5393.4	3/4"	30	55	20
53925.32	25/32"	30	71	20
53913.16	13/16"	30	71	20
5397.8	7/8"	32	72	20

3/8"DR. 12pt. Flank deep socket



53963		<i>l</i>		
Part no.	size	mm	g	pc/box
5396306	6	63	50	20
5396307	7	63	50	20
5396308	8	63	54	20
5396309	9	63	54	20
5396310	10	63	66	20
5396311	11	63	66	20
5396312	12	63	66	20
5396313	13	63	82	20
5396314	14	63	82	20
5396315	15	63	88	20
5396316	16	63	102	20
5396317	17	63	120	10
5396318	18	63	120	10
5396319	19	63	120	10
5396320	20	63	150	10
5396321	21	63	128	10
5396322	22	63	143	10
5396323 <small>NEW</small>	23	63	161	10
5396324 <small>NEW</small>	24	63	169	10
539631.4 <small>NEW</small>	1/4"	63	38	20
539635.16	5/16"	63	54	20
539633.8	3/8"	63	54	20
539637.16	7/16"	63	66	20
539631.2	1/2"	63	66	20
539639.16	9/16"	63	70	20
539635.8	5/8"	63	89	20
5396311.16	11/16"	63	100	10
539633.4	3/4"	63	120	10
5396313.16	13/16"	63	133	10
539637.8	7/8"	63	153	10
5396315.16 <small>NEW</small>	15/16"	63	167	10

3/8"DR. Spline socket



53Q						l			
Part no.	size	6point	12point	SAE	E-Torx	XZN	mm	g	pc/box
53Q06	6	6	6		E8	6	25	24	20
53Q07	7	7	7	9/32"		7	25	24	20
53Q08	8	8	8	5/16"	E10	8	25	24	20
53Q09	9	9	9	11/32"	E11	9	25	24	20
53Q10	10	10	10	3/8"	E12	10	25	24	20
53Q11	11	11	11	7/16"	E14	11	25	24	20
53Q12	12	12	12	15/32"		12	25	24	20
53Q13	13	13	13	1/2"	E16		25	32	20
53Q14	14	14	14	9/16"	E18	14	25	44	20
53Q15	15	15	15	19/32"			25	48	20
53Q16	16	16	16	5/8"	E20	16	25	60	20
53Q17	17	17	17	21/32"			25	74	20
53Q18	18	18	18	11/16"	E22	18	25	75	20
53Q19	19	19	19	3/4"	E24		25	90	20
53Q20	20	20	20	25/32"		20	25	92	20
53Q21	21	21	21	13/16"	E26		25	95	20
53Q22	22	22	22	7/8"	E28	22	25	100	20
53Q24	24	24	24	15/16"	E30	24	25	105	20

3/8"DR. Spline deep socket



53Q63						l			
Part no.	size	6point	12point	SAE	E-Torx	XZN	mm	g	pc/box
53Q6306	6	6	6		E8	6	63	50	20
53Q6307	7	7	7	9/32"		7	63	50	20
53Q6308	8	8	8	5/16"	E10	8	63	54	20
53Q6309	9	9	9	11/32"	E11	9	63	54	20
53Q6310	10	10	10	3/8"	E12	10	63	66	20
53Q6311	11	11	11	7/16"	E14	11	63	66	20
53Q6312	12	12	12	15/32"		12	63	66	20
53Q6313	13	13	13	1/2"	E16		63	82	20
53Q6314	14	14	14	9/16"	E18	14	63	86	20
53Q6315	15	15	15	19/32"			63	88	20
53Q6316	16	16	16	5/8"	E20	16	63	105	20
53Q6317	17	17	17	21/32"			63	120	10
53Q6318	18	18	18	11/16"	E22	18	63	130	10
53Q6319	19	19	19	3/4"	E24		63	138	10
53Q6320	20	20	20	25/32"		20	63	176	10
53Q6321	21	21	21	13/16"	E26		63	194	10
53Q6322	22	22	22	7/8"	E28	22	63	220	10

3/8"DR. Universal 6pt. flank socket



80535		l		
Part no.	socket	mm	g	pc/box
8053510	10	42	64	10
8053511	11	42	66	10
8053512	12	42	67	10
8053513	13	42	67	10
8053514	14	42	70	10
8053515	15	42	77	10
8053516	16	42	78	10
8053517	17	42	82	10
8053518	18	42	92	10
8053519	19	42	92	10
805353.8	3/8"	42	64	10
805357.16	7/16"	42	66	10
805351.2	1/2"	42	67	10
805359.16	9/16"	42	67	10
805355.8	5/8"	42	78	10
8053511.16	11/16"	42	82	10
805353.4	3/4"	42	92	10

3/8"DR. Universal 6pt. flank deep socket



8053585		l		
Part no.	socket	mm	g	pc/box
805358510	10	85	82	10
805358511	11	85	86	10
805358512	12	85	92	10
805358513	13	85	92	10
805358514	14	85	104	10
805358515	15	85	108	10
805358516	16	85	112	10
805358517	17	85	121	10
805358518	18	85	136	10
805358519	19	85	136	10
80535853.8	3/8"	85	82	10
80535857.16	7/16"	85	86	10
80535851.2	1/2"	85	92	10
80535859.16	9/16"	85	92	10
80535855.8	5/8"	85	112	10
805358511.16	11/16"	85	121	10
80535853.4	3/4"	85	136	10

3/8"DR. Universal star socket



80536		l		
Part no.	socket	mm	g	pc/box
8053606	E6	42	52	10
8053607	E7	42	52	10
8053608	E8	42	56	10
8053610	E10	42	56	10
8053611	E11	42	60	10
8053612	E12	42	60	10
8053614	E14	42	62	10
8053616	E16	42	62	10

3/8"DR. Spark plug socket



8073		l		
Part no.	size	mm	g	pc/box
807314 ^{NEW}	14	63	79	10
807316	16	63	96	10
807318	18	63	125	10
807320.6	20.6	63	150	10

3/8"DR. Magnetic spark plug socket



8073...M		l		
Part no.	size	mm	g	pc/box
807314M	14	70	73	10
807316M	16	70	80	10
807318M	18	70	122	10
807320.6M	20.6	70	151	10

3/8"DR. Magnetic spark plug socket (thin wall)



8073...MTH		<i>l</i>	∅		
Part no.	Size	mm	mm	g	pc/box
807314MTH	14	70	18	74	10
807316MTH	16	70	19.9	80	10
807318MTH	18	70	23	122	10
807320.6MTH	20.6	70	26	151	10

3/8"DR. QR pear ratchet handle 24teeth



80232	<i>l</i>		
Part no.	mm	g	pc/box
80232	200	354	1

* Spare part available

3/8"DR. QR pear ratchet handle 36teeth



80235	<i>l</i>		
Part no.	mm	g	pc/box
80235	180	309	1

* Spare part available

3/8"DR. QR pear ratchet handle 30teeth



802315	<i>l</i>		
Part no.	mm	g	pc/box
802315	198	324	1

* Spare part available

3/8"DR. Swivel handle



8013215	<i>l</i>		
Part no.	mm	g	pc/box
8013215	215-8.5"	307	10

* Spare part available

3/8"DR. QR thin pear ratchet handle 24teeth



80233	<i>l</i>		
Part no.	mm	g	pc/box
80233	189	294	1

* Spare part available

3/8"DR. QR pear ratchet handle 72teeth



80238	<i>l</i>		
Part no.	mm	g	pc/box
80238	190	272	1

* Spare part available

3/8"DR. QR flexible pear ratchet handle 30teeth



802318	<i>l</i>		
Part no.	mm	g	pc/box
802318	273	460	1

* Spare part available

3/8"DR. Bent swivel handle



8013200B	<i>l</i>		
Part no.	mm	g	pc/box
8013200B	200-8"	307	10

* Spare part available

3/8"DR. QR thin pear ratchet handle 24teeth



80234	<i>l</i>		
Part no.	mm	g	pc/box
80234	175	306	1

* Spare part available

3/8"DR. Round ratchet handle 72teeth



80239	<i>l</i>		
Part no.	mm	g	pc/box
80239	189	248	1

* Spare part available

3/8"DR. QR stubby pear ratchet handle 30teeth



802319	<i>l</i>		
Part no.	mm	g	pc/box
802319	134	250	1

* Spare part available

3/8"DR. Round ratchet handle 72teeth



802322	<i>l</i>		
Part no.	mm	g	pc/box
802322	188	300	1

* Spare part available

3/8"DR. Sliding T handle



8033165	<i>l</i>		
Part no.	mm	g	pc/box
8033165	165	182	10

3/8"DR. Flexible round ratchet handle 72teeth



802323	<i>l</i>		
Part no.	mm	g	pc/box
802323	230	404	1

* Spare part available

3/8"DR. Locking sliding T handle

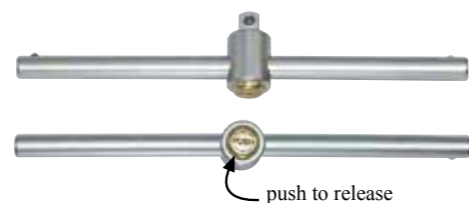

8033200L	<i>l</i>		
Part no.	mm	g	pc/box
8033200L	200-8"	184	10

3/8"DR. QR curved-shank ratchet handle 36teeth

NEW



802327	<i>l</i>		
Part no.	mm	g	pc/box
802327	195	278	1

* Spare part available

3/8"DR. Extension



8043	<i>l</i>		
Part no.	mm	g	pc/box
8043044	44-1.75"	41	10
8043075	75-3"	78	10
8043100	100-4"	88	10
8043125	125-5"	118	10
8043150	150-6"	148	10
8043200	200-8"	187	10
8043225	225-9"	220	10
8043250	250-10"	242	10
8043300	300-12"	291	10
8043450	450-18"	403	10

3/8"DR. Thin extension



8043...R	<i>l</i>		
Part no.	mm	g	pc/box
8043150R	150-6"	120	10
8043225R	225-9"	178	10
8043300R	300-12"	235	10

3/8"DR. Wobble extension



8043...W	<i>l</i>		
Part no.	mm	g	pc/box
8043044W	44-1.75"	45	10
8043075W	75-3"	67	10
8043150W	150-6"	120	10
8043225W	225-9"	172	10
8043250W	250-10"	220	10

3/8"DR. Locking extension



8083	<i>l</i>		
Part no.	mm	g	pc/box
808306	150-6"	157	10
808310	250-10"	249	10

3/8"DR. Universal joint



80531	<i>l</i>		
Part no.	mm	g	pc/box
80531	46	61	10

3/8"DR. Universal joint (extension type)

NEW

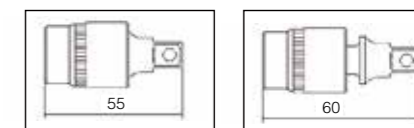
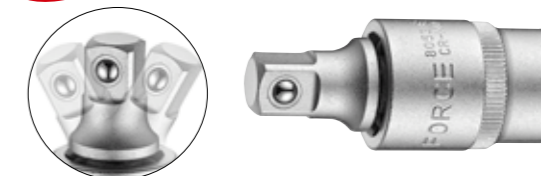

80531E	<i>l</i>		
Part no.	mm	g	pc/box
80531E	55-60	92	10

Adapter for 3/8"DR. extension



806	<i>l</i>			
Part no.	size	mm	g	pc/box
80633	3/8"(F)x3/8"(M)	35	38	20
80643	1/2"(F)x3/8"(M)	46	68	10

3/8"DR. Adapter



8093		<i>l</i>		
Part no.	size	mm	g	pc/box
80932	3/8"(F)x1/4"(M)	35	31	10
80934	3/8"(F)x1/2"(M)	46	47	10

3/8"DR. Speed handle

NEW



8153360A		<i>l</i>		
Part no.	size	mm	g	pc/box
8153360A	3/8"	370	315	5

3/8"DR. Plastic hanger

NEW



PI8023		<i>l</i>	
Part no.	size	mm	g
PI8023	3/8"DR.	155	20

3/8"DR. Long adapter



80934062		<i>l</i>		
Part no.	size	mm	g	pc/box
80934062	3/8"(F)x1/2"(M)	61.5	85	10

3/8"DR. Speed T handle



8193T		<i>l</i>		
Part no.	size	mm	g	pc/box
8193T	3/8"	250	449	10

3/8"DR. Plastic hanger

NEW



PI8033		<i>l</i>	
Part no.	size	mm	g
PI8033	3/8"DR.	105	10

3/8"DR. Bit holder



8103		<i>l</i>		
Part no.	size	mm	g	pc/box
81032	3/8"DRx1/4"(F)	30	27	20
81035	3/8"DRx5/16"(F)	30	38	20
81037	3/8"DRx10mm(F)	30	38	20

3/8" DR. Socket rail



8193		<i>l</i>	
Part no.	PCS	mm	g
819307	7	160	26
819313	13	280	46
819320	20	560	126

3/8"DR. Plastic hanger



8163		<i>l</i>	
Part no.	size	mm	g
8163	3/8"DR.	67	4

12pc 1/2"DR. Socket set

NEW



4125 24/21.3/22.3/1.1' Δ 888g

12pc 10; 12; 13; 14; 15; 16; 17; 18; 19; 21; 22; 24 mm

4125-9 24/21.3/22.3/1.1' Δ 888g

12pc 10; 12; 13; 14; 15; 16; 17; 18; 19; 21; 22; 24 mm

10pc 1/2"DR. Socket set

NEW



41015 24/18.8/19.8/0.89' Δ 782g

10pc 13; 14; 15; 16; 17; 18; 19; 21; 22; 24 mm

41015-9 24/18.8/19.8/0.89' Δ 782g

10pc 13; 14; 15; 16; 17; 18; 19; 21; 22; 24 mm

10pc 1/2"DR. Socket set

NEW



41018 36/22.9/23.9/1.1' Δ 636g

10pc 10; 11; 12; 13; 14; 15; 16; 17; 18; 19 mm

41018-9 36/22.9/23.9/1.1' Δ 636g

10pc 10; 11; 12; 13; 14; 15; 16; 17; 18; 19 mm

8pc 1/2"DR. Socket set

NEW



40815 24/24.6/25.6/1.1' Δ 1024g

8pc 20; 21; 22; 23; 24; 27; 30; 32 mm

40815-9 24/24.6/25.6/1.1' Δ 1024g

8pc 20; 21; 22; 23; 24; 27; 30; 32 mm

21pc 1/2"DR. Socket set



4212 6/16.0/17.0/0.9' Δ 2666g

21pc 8; 10; 11; 12; 13; 14; 15; 16; 17; 18; 19; 20; 21; 22; 23; 24; 26; 27; 28; 30; 32 mm

4212-7 6/16.0/17.0/0.9' Δ 2666g

21pc 8; 10; 11; 12; 13; 14; 15; 16; 17; 18; 19; 20; 21; 22; 23; 24; 26; 27; 28; 30; 32 mm

4212-9 6/16.0/17.0/0.9' Δ 2666g

21pc 8; 10; 11; 12; 13; 14; 15; 16; 17; 18; 19; 20; 21; 22; 23; 24; 26; 27; 28; 30; 32 mm

7pc 1/2"DR. Deep socket set



40711 12/16.1/17.1/1' Δ 1340g

7pc 8; 10; 12; 13; 14; 17; 19 mm (77mmL)

40711-9 12/16.1/17.1/1' Δ 1340g

7pc 8; 10; 12; 13; 14; 17; 19 mm (77mmL)

8pc 1/2"DR. Deep socket set



4082 12/17.3/18.3/1' Δ 1440g

8pc 13; 14; 15; 17; 19; 21; 22; 24 mm (77mmL)

4082-9 12/17.3/18.3/1' Δ 1440g

8pc 13; 14; 15; 17; 19; 21; 22; 24 mm (77mmL)

10pc 1/2"DR. Deep socket set

NEW



41015D 12/18.3/19.3/0.79' Δ 1524g

10pc 13; 14; 15; 16; 17; 18; 19; 21; 22; 24 mm (77mmL)

41015D-9 12/18.3/19.3/0.79' Δ 1524g

10pc 13; 14; 15; 16; 17; 18; 19; 21; 22; 24 mm (77mmL)

9pc 1/2"DR. Deep socket set



40911 12/17.3/18.3/1' Δ 1440g

9pc 10; 12; 13; 14; 17; 19; 21; 22; 24 mm (77mmL)

40911-9 12/17.3/18.3/1' Δ 1440g

9pc 10; 12; 13; 14; 17; 19; 21; 22; 24 mm (77mmL)

10pc 1/2"DR. Deep socket set

NEW



41018D 12/13.8/14.8/0.67' Δ 1146g

10pc 10; 11; 12; 13; 14; 15; 16; 17; 18; 19 mm (77mmL)

41018D-9 12/13.8/14.8/0.67' Δ 1146g

10pc 10; 11; 12; 13; 14; 15; 16; 17; 18; 19 mm (77mmL)

14pc 1/2"DR. Deep socket set



4143 6/18.6/19.6/0.9' 3100g

	14pc	10; 12; 13; 14; 15; 17; 19; 21; 22; 23; 24; 27; 30; 32 mm (77mmL)
--	------	---

4143-9 6/18.6/19.6/0.9' 3100g

	14pc	10; 12; 13; 14; 15; 17; 19; 21; 22; 23; 24; 27; 30; 32 mm (77mmL)
--	------	---

16pc 1/2"DR. Deep socket set

NEW



4163 6/19.9/20.9/1.54' 3320g

	16pc	10; 11; 12; 13; 14; 15; 16; 17; 18; 19; 21; 22; 24; 27; 30; 32 mm (77mmL)
--	------	---

4163-9 6/19.9/20.9/1.54' 3320g

	16pc	10; 11; 12; 13; 14; 15; 16; 17; 18; 19; 21; 22; 24; 27; 30; 32 mm (77mmL)
--	------	---

17pc 1/4" & 3/8" & 1/2" 6pt. Flank deep socket set

NEW



4178 12/19.2/20.2/2' 1604g

	7pc	1/4"DR. 6; 7; 8; 9; 10; 11; 12 mm (50mmL)
	6pc	3/8"DR. 13; 14; 15; 16; 17; 18 mm (63mmL)
	4pc	1/2"DR. 19; 21; 22; 24 mm (77mmL)



21pc 1/2"DR. 6pt. Flank socket set

NEW



4217 6/21.6/22.6/0.9' 3600g

	6pc	25; 26; 27; 28; 30; 32 mm
	15pc	10; 11; 12; 13; 14; 15; 16; 17; 18; 19; 20; 21; 22; 23; 24 mm (77mmL)

12pc 1/2"DR. Socket set (SAE)

NEW



4127 12/11.2/12.2/0.73' 930g

	12pc	5/16"; 3/8"; 7/16"; 1/2"; 9/16"; 5/8"; 11/16"; 3/4"; 13/16"; 7/8"; 15/16"; 1"
--	------	---

4127-9 12/11.2/12.2/0.73' 930g

	12pc	5/16"; 3/8"; 7/16"; 1/2"; 9/16"; 5/8"; 11/16"; 3/4"; 13/16"; 7/8"; 15/16"; 1"
--	------	---

19pc 1/2"DR. Socket set (SAE)



4194 6/14.8/15.8/0.9' 2470g

	19pc	5/16"; 3/8"; 7/16"; 15/32"; 1/2"; 9/16"; 19/32"; 5/8"; 11/16"; 3/4"; 25/32"; 13/16"; 7/8"; 15/16"; 1"; 1-1/16"; 1-1/8"; 1-3/16"; 1-1/4"
--	------	---

4194-7 6/14.8/15.8/0.9' 2470g

	19pc	5/16"; 3/8"; 7/16"; 15/32"; 1/2"; 9/16"; 19/32"; 5/8"; 11/16"; 3/4"; 25/32"; 13/16"; 7/8"; 15/16"; 1"; 1-1/16"; 1-1/8"; 1-3/16"; 1-1/4"
--	------	---

4194-9 6/14.8/15.8/0.9' 2470g

	19pc	5/16"; 3/8"; 7/16"; 15/32"; 1/2"; 9/16"; 19/32"; 5/8"; 11/16"; 3/4"; 25/32"; 13/16"; 7/8"; 15/16"; 1"; 1-1/16"; 1-1/8"; 1-3/16"; 1-1/4"
--	------	---

10pc 1/2"DR. Deep socket set (SAE)

NEW



4106DS 12/16.6/17.6/0.67' 1386g

	10pc	3/8"; 7/16"; 1/2"; 9/16"; 5/8"; 11/16"; 3/4"; 13/16"; 7/8"; 15/16" (77mmL)
--	------	--

4106DS-9 12/16.6/17.6/0.67' 1386g

	10pc	3/8"; 7/16"; 1/2"; 9/16"; 5/8"; 11/16"; 3/4"; 13/16"; 7/8"; 15/16" (77mmL)
--	------	--

7pc 1/2"DR. Star socket set



4071 20/20.0/21.0/1.1' 1000g

	7pc	E10; E12; E14; E16; E18; E20; E24
--	-----	-----------------------------------

9pc 1/2"DR. Star socket set



4093 20/24.0/25.0/1.1' 1200g
 9pc E10; E11; E12; E14; E16; E18; E20; E22; E24

10pc 1/2"DR. Star socket set



41019 36/24.4/25.4/1.1' 676g
 10pc E8; E10; E11; E12; E14; E16; E18; E20; E22; E24

9pc 3/8" & 1/2" Star socket set



4095 36/23.3/24.3/1.6' 647g
 4pc 3/8"DR. E10; E11; E12; E14
 5pc 1/2"DR. E16; E18; E20; E22; E24

11pc 1/4" & 3/8" & 1/2" Star socket set



4113 36/16.5/17.5/1.6' 458g
 4pc 1/4"DR. E5; E6; E7; E8
 4pc 3/8"DR. E10; E11; E12; E14
 3pc 1/2"DR. E16; E18; E20

14pc 1/4" & 3/8" & 1/2" Star socket set



4158 20/13.0/14.0/1' 650g
 5pc 1/4"DR. E4; E5; E6; E7; E8
 4pc 3/8"DR. E10; E11; E12; E14
 5pc 1/2"DR. E16; E18; E20; E22; E24

8pc 1/2"DR. Star deep socket set



4083 12/13.5/14.5/1' 1125g
 8pc E10; E11; E12; E14; E16; E18; E20; E24 (77mmL)

10pc 1/2"DR. Star deep socket set



41019D 12/14.6/15.6/0.67' 1220g
 10pc E8; E10; E11; E12; E14; E16; E18; E20; E22; E24 (77mmL)

6pc 1/2"DR. Star extra-long deep socket set



40616 10/17.3/18.3/1.2' 1732g
 6pc E10; E12; E14; E16; E18; E20 (150mmL)

12pc 1/2"DR. Spline socket set



4124Q 36/33.3/34.3/1.6' 896g
 12pc 10; 11; 12; 13; 14; 15; 16; 17; 19; 21; 22; 24 mm

10pc 1/2"DR. Spline deep socket set



41014Q 24/30.9/31.9/1.4' 1286g
 10pc 10; 11; 12; 13; 14; 15; 17; 19; 22; 24 mm (77mmL)

10pc 1/2"DR. Universal socket set

NEW



41015R		12/18.4/19.4/0.79'		1534g
	10pc	13; 14; 15; 16; 17; 18; 19; 21; 22; 24 mm		

8pc 1/2"DR. Universal deep socket set

NEW



4084R		12/22.2/23.2/0.79'		1850g
	8pc	13; 14; 15; 17; 19; 21; 22; 24 mm (108mmL)		

8pc 1/2"DR. Universal socket set (SAE)

NEW



4085SR		12/14.9/15.9/0.79'		1242g
	8pc	1/2"; 9/16"; 5/8"; 11/16"; 3/4"; 13/16"; 7/8"; 15/16"		

8pc 1/2"DR. Universal deep socket set (SAE)

NEW



4084SR		12/21.9/22.9/0.79'		1828g
	8pc	1/2"; 9/16"; 5/8"; 11/16"; 3/4"; 13/16"; 7/8"; 15/16" (108mmL)		

5pc 1/2"DR. Hex socket bit set



4056		20/17.0/18.0/1'		850g
	5pc	10; 12 mm (55mmL) 14 mm (65mmL) 17; 19 mm (70mmL)		

7pc 1/2"DR. Hex socket bit set

NEW



40715		36/23.8/24.8/1.3'		632g
	7pc	5; 6; 7; 8; 10; 12 mm (55mmL) 14 mm (65mmL)		

8pc 1/2"DR. Hex socket bit set



4091		20/22.5/23.5/0.82'		1125g
	8pc	5; 6; 7; 8; 10; 12 mm (55mmL) 14 mm (65mmL) 17 mm (70mmL)		

4091S		20/22.5/23.5/0.82'		1125g
	8pc	5/32"; 3/16"; 1/4"; 5/16"; 3/8"; 1/2" (55mmL) 9/16"; 5/8" (65mmL)		

9pc 1/2"DR. Hex socket bit set



4101		15/20.0/21.0/1'		1334g
	9pc	4; 5; 6; 7; 8; 10; 12 mm (55mmL) 14 mm (65mmL) 17 mm (70mmL)		

4101S		15/20.0/21.0/1'		1334g
	9pc	5/32"; 3/16"; 7/32"; 1/4"; 5/16"; 3/8"; 1/2" (55mmL) 9/16"; 5/8" (65mmL)		

10pc 1/2"DR. Hex socket bit set



4111			15/23.4/24.4/1'		1560g
	10pc	4; 5; 6; 7; 8; 10; 12 mm (55mmL)			
		14 mm (65mmL)			
		17; 19 mm (70mmL)			

4111S			15/23.4/24.4/1'		1560g
	10pc	5/32"; 3/16"; 7/32"; 1/4"; 5/16"; 3/8"; 1/2" (55mmL)			
		9/16"; 5/8" (65mmL)			
		3/4" (70mmL)			

7pc 1/2"DR. Hex socket bit set

NEW



40715L			24/19.7/20.7/1.1'		818g
	7pc	5; 6; 7; 8; 10; 12; 14 mm (100mmL)			

8pc 1/2"DR. Hex socket bit set



4092			10/19.8/20.8/1'		1980g
	8pc	5; 6; 7; 8; 10; 12; 14; 17 mm (110mmL)			

17pc 1/2"DR. Hex socket bit set

NEW



41710			6/16.3/17.3/0.66'		2714g
	9pc	5; 6; 7; 8; 10; 12 mm (55mmL)			
		14mm (65mmL)			
		17; 19 mm (70mmL)			
	8pc	5; 6; 7; 8; 10; 12; 14 mm (100mmL)			
		17mm (110mmL)			

5pc 1/2"DR. Star socket bit set



4051			30/19.3/20.3/0.9'		643g
	5pc	T40; T45; T50; T55; T60 (55mmL)			

6pc 1/2"DR. Star socket bit set



4062			25/15.8/16.8/0.64'		632g
	6pc	T25; T30; T40; T45; T50; T55 (55mmL)			

7pc 1/2"DR. Star socket bit set

NEW



40717			36/22.3/23.3/1.3'		620g
	7pc	T30; T40; T45; T50; T55; T60; T70 (55mmL)			

9pc 1/2"DR. Star socket bit set



4102			20/22.0/23.0/0.82'		1100g
	9pc	T20; T25; T27; T30; T40; T45; T50; T55; T60 (55mmL)			

9pc 1/2"DR. Star socket bit set

NEW



40913

36/24.3/25.3/1.3' Δ 670g

	9pc	T20; T25; T27; T30; T40; T45; T50; T55; T60 (55mmL)
--	-----	---

9pc 1/2"DR. Star tamperproof socket bit set

NEW



40913T

36/24.2/25.2/1.3' Δ 666g

	9pc	T-20H; T-25H; T-27H; T-30H; T-40H; T-45H; T-50H; T-55H; T-60H (55mmL)
--	-----	---

7pc 1/2"DR. Star socket bit set

NEW



40717L

36/29.0/30.0/1.3' Δ 806g

	7pc	T30; T40; T45; T50; T55; T60; T70 (100mmL)
--	-----	--

9pc 1/2"DR. Star tamperproof socket bit set

NEW



40913LT

24/20.1/21.1/1.1' Δ 836g

	9pc	T-20H; T-25H; T-27H; T-30H; T-40H; T-45H; T-50H; T-55H; T-60H (100mmL)
--	-----	--

9pc 1/2"DR. Star socket bit set

NEW



40913L

24/20.6/21.6/1.1' Δ 842g

	9pc	T20; T25; T27; T30; T40; T45; T50; T55; T60 (100mmL)
--	-----	--

7pc 1/2"DR. Spline socket bit set

NEW



40716

36/23.5/24.5/1.3' Δ 632g

	7pc	M5; M6; M8; M9; M10; M12; M14 (55mmL)
--	-----	---------------------------------------

16pc 1/2"DR. Star socket bit set

NEW



4165

6/12.8/13.8/0.9' Δ 2126g

	8pc	T27; T30; T40; T45; T50; T55; T60; T70 (55mmL)
	8pc	T27; T30; T40; T45; T50; T55; T60; T70 (100mmL)

8pc 1/2"DR. Spline socket bit set

40811

20/19.2/20.2/0.82' Δ 960g



	8pc	M5; M6; M8; M9; M10; M12; M14; M16 (55mmL)
--	-----	--



7pc 1/2"DR. Spline socket bit set

NEW







40716L  24/20.4/21.4/1.1'  845g

	7pc	M5; M6; M8; M9; M10; M12; M14 (100mmL)
---	-----	--

6pc 1/2"DR. Spline socket bit set





4061  20/21.0/22.0/0.82'  1050g



	3pc	M6; M8; M10 (55mmL)
	3pc	M8; M10; M12 (100mmL)

17pc 1/2"DR. Spline socket bit set

NEW





4179  6/15.5/16.5/0.9'  2582g

	8pc	M5; M6; M8; M9; M10; M12; M14; M16 (55mmL)
	8pc	M5; M6; M8; M9; M10; M12; M14; M16 (100mmL)
	1pc	M16 (55mmL)

9pc 1/2"DR. Ribe socket bit set

NEW







40915  24/26.6/27.6/1.1'  1090g

	9pc	M5; M6; M7; M8; M9; M10; M12; M13; M14 (100mmL)
---	-----	---

20pc 1/2"DR. Hex socket bit set







4206  4/13.0/14.0/1.3'  3250g

	10pc	5; 6; 7; 8; 9; 10; 12 mm (55mmL) 14 mm (65mmL) 17; 19 mm (70mmL)
	10pc	5; 6; 7; 8; 10; 11; 12; 13; 14 mm (100mmL) 17 mm (110mmL)

26pc 1/2"DR. Star socket bit set









4263  4/14.9/15.9/1.3'  3725g

	12pc	T20; T25; T27; T30; T35; T40; T45; T47; T50; T55; T60; T70 (55mmL)
	14pc	T20; T25; T27; T30; T40; T45; T50; T55; T60; T70; T80; T90; T100 (100mmL) T60 (140mmL)

28pc 1/2"DR. Spline socket bit set









4285  4/17.6/18.6/1.3'  4400g

	8pc	M5; M6; M8; M9; M10; M12; M14; M16 (55mmL)
	15pc	M5; M6; M8; M9; M9.5; M10; M12; M14; M16; M18 (100mmL) M8; M9; M10; M12; M14 (140mmL)
	2pc	M14; M16 (55mmL)
	1pc	M16 (100mmL)
	2pc	M10 Alternator tools (674)

26pc 1/2"DR. Ribe socket bit set















4265  4/15.7/16.7/1.3'  3925g

	1pc	M6 (55mmL)
	15pc	M5; M6; M7; M8; M9; M10; M12; M13; M14; M16 (100mmL) M8; M9; M10; M12; M14 (140mmL)
	1pc	M10S (140mmL)
	9pc	M5; M6; M7; M8; M9; M10; M12; M14; M16 (63mmL)

26pc 1/2"DR. Auto special socket bit set







4266  4/18.8/19.8/1.3'  4700g

	3pc	11; 13 mm (100mmL) 10 mm (140mmL)
	3pc	T60; T70 (100mmL) T60 (140mmL)
	4pc	T-55H (100mmL) T-70H (105mmL) T-30H (130mmL) T-80H (140mmL)
	6pc	M14 (100mmL) M9 (120mmL) M8; M9; M10; M12 (140mmL)
	1pc	M16 (55mmL)
	1pc	M16 (100mmL)
	3pc	M13 (100mmL) M12 (120mmL) M9 (140mmL)
	1pc	M10S (140mmL)
	2pc	M10 Alternator tools (674)
	2pc	T50 Alternator tools (678)

11pc 1/2"DR. Socket bit set







4116  6/13.5/14.5/0.9'  2250g

	5pc	7mm (100mmL); 8mm (120mmL); 10mm (140mmL); 6mm (160mmL); 5mm (180mmL)
	3pc	T70 (100mmL) T45; T55 (140mmL)
	3pc	M8 (100mmL); M10 (120mmL); M12 (140mmL)

12pc 1/2"DR. Socket bit set









4122  6/13.0/14.0/0.9'  2160g

	4pc	6; 7; 8 mm (100mmL) 5mm (180mmL)
	4pc	T40; T45 (120mmL) T55; T70 (140mmL)
	4pc	M6; M8; M10; M12 (100mmL)

27pc 3/8" & 1/2" Socket bit set









4281  6/21.0/22.0/0.9'  3500g

	6pc	3/8"DR. 4; 5; 6; 7; 8; 10 mm (50mmL)
	9pc	1/2"DR. 4; 5; 6; 7; 8; 10; 12 mm (55mmL) 14mm (65mmL); 17mm (70mmL)
	2pc	1/2"DR. 8mm (80mmL); 10mm (140mmL)
	7pc	1/2"DR. M5; M6; M8; M10; M12; M14; M16 (55mmL)
	3pc	1/2"DR. M10; M12 (110mmL); M8 (120mmL)

32pc 1/2"DR. Star & spline set





T4322  6/18.7/19.7/0.8'  3120g





	8pc	E10; E11; E12; E14; E16; E18; E20; E24
	8pc	E10; E11; E12; E14; E16; E18; E20; E24 (77mmL)
	4pc	T50; T55; T60; T70 (55mmL)
	4pc	T-50H; T-55H; T-60H; T-70H (55mmL)
	8pc	M5; M6; M8; M9; M10; M12; M14; M16 (55mmL)

35pc 1/2"DR. Socket bit & star socket set

NEW





T4355  6/20.0/21.0/0.66'  3330g

	9pc	E10; E11; E12; E14; E16; E18; E20; E22; E24 5; 6; 7; 8; 10; 12 mm (55mmL)
	9pc	14 mm (65mmL) 17; 19 mm (70mmL)
	8pc	T27; T30; T40; T45; T50; T55; T60; T70 (55mmL)
	8pc	M5; M6; M8; M9; M10; M12; M14; M16 (55mmL)
	1pc	M16 (55mmL)

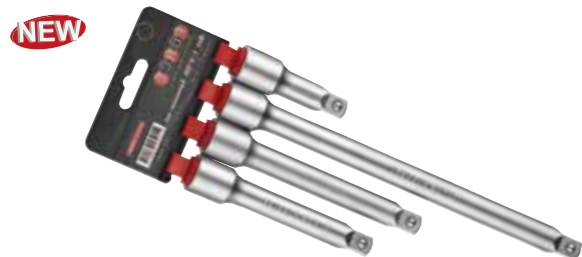
4pc 1/2"DR. Extension set









4049  20/21.4/22.4/0.57'  1070g

	4pc	3"(75mm); 5"(125mm); 6"(150mm); 10"(250mm)
---	-----	--

5pc 1/2"DR. Accessory set









4057  6/15.0/16.0/0.9'  2500g

	1pc	Round ratchet handle 72teeth (80249)
	2pc	5"(125mm); 10"(250mm)
	1pc	10"(250mm)
	1pc	1/2"

6pc 1/2"DR. Accessory set









40612  6/16.5/17.5/0.9'  2750g

	1pc	QR pear ratchet handle 36teeth (802415)
	1pc	15"(380mm)
	2pc	5"(125mm); 10"(250mm)
	1pc	10"(250mm)
	1pc	1/2"

6pc 1/2"DR. Accessory set





40613-23  6/16.5/17.5/0.9'  2750g

	1pc	Flexible round ratchet handle 72teeth (802423)
	1pc	15"(380mm)
	2pc	5"(125mm); 10"(250mm)
	1pc	10"(250mm)
	1pc	1/2"

8pc Adapter set







K4087  24/26.5/27.5/1.5'  1750g

	8pc	1/4"(F)x3/8"(M); 3/8"(F)x1/4"(M); 3/8"(F)x1/2"(M); 1/2"(F)x3/8"(M); 1/2"(F)x3/4"(M); 3/4"(F)x1/2"(M); 3/4"(F)x1"(M); 1"(F)x3/4"(M)
---	-----	---

14pc 1/2"DR. Star set







4157  20/18.0/19.0/0.82'  900g

	6pc	E10; E12; E14; E16; E18; E20
	7pc	10mm T25; T27; T30; T40; T45; T50; T55 (30mmL)
	1pc	1/2"DR.x10mm(F)

16pc 1/2"DR. Star set







4171  10/20.0/21.0/0.7'  2000g

	9pc	E10; E11; E12; E14; E16; E18; E20; E22; E24
	7pc	T30; T40; T45; T50; T55; T60; T70 (55mmL)

16pc 1/2"DR. Star set



4172  10/20.0/21.0/0.7'  2000g

	9pc	E10; E11; E12; E14; E16; E18; E20; E22; E24
	7pc	T40; T45; T47; T50; T55; T60; T70 (55mmL)

18pc 3/8" & 1/2" Star set



4192 10/16.5/17.5/0.7" 1650g

	6pc	3/8"DR. E10; E11; E12; E14; E16; E18
	3pc	1/2"DR. E20; E22; E24
	5pc	3/8"DR. T20; T25; T27; T30; T40 (50mmL)
	4pc	1/2"DR. T45; T50; T55; T60 (55mmL)

32pc 1/4" & 3/8" & 1/2" Star set

NEW



4326 6/8.3/9.3/0.9" 1382g

	5pc	1/4"DR. E4; E5; E6; E7; E8
	4pc	3/8"DR. E10; E11; E12; E14
	5pc	1/2"DR. E16; E18; E20; E22; E24
	8pc	10mm T20 T25; T27; T30; T40; T45; T50; T55 (30mmL)
	8pc	10mm T20 T25; T27; T30; T40; T45; T50; T55 (75mmL)
	1pc	3/8"DR.x10mm(F)
	1pc	1/2"DR.x10mm(F)

35pc 1/4" & 3/8" & 1/2" Star set



4352 15/21.3/22.3/1" 1420g

	5pc	1/4"DR. E4; E5; E6; E7; E8
	7pc	3/8"DR. E10; E11; E12; E14; E16; E18; E20
	1pc	1/4" T9 (30mmL)
	7pc	10mm T25; T27; T30; T40; T45; T50; T55 (75mmL)
	2pc	14mm T60; T70 (75mmL)
	3pc	1/4" T-10H; T-15H; T-20H (30mmL)
	6pc	10mm T-25H; T-27H; T-30H; T-40H; T-45H; T-50H (30mmL)
	1pc	1/4"DR.x1/4"(F)
	1pc	3/8"DR.x10mm(F)
	2pc	1/2"DR.x10mm(F); 1/2"DR.x14mm(F)

41pc 1/4" & 3/8" & 1/2" Star set



4411 6/14.8/15.8/0.9" 2466g

	5pc	1/4"DR. E4; E5; E6; E7; E8
	7pc	3/8"DR. E10; E11; E12; E14; E16; E18; E20
	4pc	1/4" T9; T10; T15; T20 (30mmL)
	6pc	10mm T25; T27; T30; T40; T45; T50 (30mmL)
	1pc	10mm T55 (115mmL)
	2pc	14mm T60; T70 (75mmL)
	1pc	1/4"DR.x1/4"(F)
	1pc	3/8"DR.x10mm(F)
	1pc	1/2"DR.x14mm(F)
	13pc	T9; T10; T15; T20; T25; T27; T30; T40; T45; T50; T55; T60; T70

41pc 1/4" & 3/8" & 1/2" Star set



7pc	T10; T15; T20; T25; T27; T30; T40 (5071)
5pc	T45; T50; T55; T60; T70

73pc 1/4" & 1/2" Star set



T4413 6/12.8/13.8/0.8" 2130g

	6pc	1/4"DR. E4; E5; E6; E7; E8; E10
	7pc	3/8"DR. E10; E11; E12; E14; E16; E18; E20
	2pc	1/2"DR. E22; E24
	9pc	1/4"DR. T8; T9; T10; T15; T20; T25; T27; T30; T40 (32mmL)
	2pc	3/8"DR. T45; T50 (50mmL)
	3pc	1/2"DR. T60; T70 (100mmL)
		T55 (140mmL)

4731 3/13.5/14.5/1" 4500g

	7pc	1/4"DR. E4; E5; E6; E7; E8; E10; E11
	7pc	1/2"DR. E12; E14; E16; E18; E20; E22; E24
	6pc	1/4"DR. T8; T10; T15; T20; T25; T27 (32mmL)
	6pc	1/2"DR. T30; T40; T45; T50; T55; T60 (55mmL)
	10pc	10mm T10; T15; T20; T25; T27; T30; T40; T45; T50; T55 (75mmL)
	10pc	10mm T-10H; T-15H; T-20H; T-25H; T-27H; T-30H; T-40H; T-45H; T-50H; T-55H (30mmL)
	1pc	1/2"DR.x10mm(F)
		T-6H; T-8H; T-10H; T-15H (80mmL)
	9pc	T-20H; T-25H (100mmL)
		T-27H; T-30H (115mmL)
		T-40H (130mmL)
	4pc	E6xE8; E10xE12; E14xE18; E20xE24
	13pc	T8; T10; T15; T20; T25; T27; T30; T40; T45; T50; T55; T60; T70

92pc 1/4" & 1/2" Star set



6pc	75° offset E6xE8; E7xE11; E10xE12; E14xE18; E16xE22; E20xE24
14pc	T6; T7; T8; T9; T10; T15; T20; T25; T27; T30; T40; T45; T50; T55
20pc	Star screw measure set (5201)

4921 2/11.7/12.7/0.77" 5850g

	7pc	1/4"DR. E4; E5; E6; E7; E8; E10; E11
	7pc	1/2"DR. E12; E14; E16; E18; E20; E22; E24
	2pc	1/4" T6; T7 (25mmL)
	1pc	10mm T47 (30mmL)
	2pc	1/2"DR. T60 (55mmL); T80 (70mmL)
	1pc	1/4" T25 (65mmL)
	3pc	10mm T40; T45; T50 (75mmL)
	2pc	1/2"DR. T70 (100mmL); T55 (140mmL)
	10pc	1/4" T-8H; T-9H; T-10H; T-15H; T-20H; T-25H; T-27H; T-30H; T-35H; T-40H (25mmL)
	4pc	10mm T-40H; T-45H; T-50H; T-55H (30mmL)
	2pc	1/4"DR.x1/4"(F); 1/2"DR.x10mm(F)
	1pc	T6 (60mmL)
		T-7H; T-8H; T-9H (60mmL)
		T-10H; T-15H (80mmL)
	10pc	T-20H; T-25H (100mmL)
		T-27H; T-30H (115mmL)
		T-40H (130mmL)

15pc 1/2"DR. Whitworth (WW) socket combination set



41512 6/21.6/22.6/0.8" 3600g

	9pc	12pt. WW 3/16"; 1/4"; 5/16"; 3/8"; 7/16"; 1/2"; 9/16"; 5/8"; 3/4"
	1pc	QR thin pear ratchet handle 24teeth (80244)
	1pc	10"(250mm)
	1pc	10"(250mm)
	1pc	Wobble extension 5"(125mm)
	1pc	1/2"
	1pc	3/8"(F)x1/2"(M) for extension

16pc 1/2"DR. Socket combination set



4161 6/20.8/21.8/0.68" 3466g

	13pc	10; 11; 12; 13; 14; 15; 17; 19; 21; 22; 24; 26; 27 mm
	1pc	QR thin pear ratchet handle 24teeth (80244)
	1pc	15"(380mm)
	1pc	5"(125mm)

4161-7 6/20.8/21.8/0.68" 3466g

Changed items

	13pc	10; 11; 12; 13; 14; 15; 17; 19; 21; 22; 24; 26; 27 mm
--	------	---

4161-9 6/20.8/21.8/0.68" 3466g

Changed items

	13pc	10; 11; 12; 13; 14; 15; 17; 19; 21; 22; 24; 26; 27 mm
--	------	---

16pc 1/2"DR. Socket combination set



4162 6/21.0/22.0/0.7" 3500g

	12pc	10; 11; 12; 13; 14; 17; 19; 22; 24; 27; 30; 32 mm
	1pc	QR pear ratchet handle 24teeth (80242)
	1pc	5"(125mm)
	1pc	12"(300mm)
	1pc	1/2"

4162-5 6/21.0/22.0/0.7" 3500g

Changed items

	12pc	10; 11; 12; 13; 14; 17; 19; 22; 24; 27; 30; 32 mm
--	------	---

4162-7 6/21.0/22.0/0.7" 3500g

Changed items

	12pc	10; 11; 12; 13; 14; 17; 19; 22; 24; 27; 30; 32 mm
--	------	---

17pc 1/2"DR. Socket combination set



4173 6/16.0/17.0/0.7" 2660g

	13pc	8; 10; 11; 12; 13; 14; 15; 16; 17; 19; 21; 23; 26 mm
	1pc	Spark plug 20.6mm
	1pc	QR thin pear ratchet handle 24teeth (80243)
	1pc	5"(125mm)
	1pc	10"(250mm)

4173-5 6/16.0/17.0/0.7" 2660g

Changed items

	13pc	8; 10; 11; 12; 13; 14; 15; 16; 17; 19; 21; 23; 26 mm
--	------	--

4173-4 6/16.0/17.0/0.7" 2660g

Changed items

	1pc	QR thin pear ratchet handle 24teeth (80244)
--	-----	---

4173-9 6/16.0/17.0/0.7" 2660g

Changed items

	13pc	8; 10; 11; 12; 13; 14; 15; 16; 17; 19; 21; 23; 26 mm
--	------	--

22pc 1/2"DR. Socket combination set



4223 5/19.3/20.3/1.4" 3860g

	15pc	10; 11; 12; 13; 14; 15; 16; 17; 18; 19; 22; 24; 27; 30; 32 mm
	2pc	Spark plug 16; 20.6 mm
	1pc	QR thin pear ratchet handle 24teeth (80243)
	2pc	5"(125mm); 10"(250mm)
	1pc	1/2"
	1pc	3/8"(F)x1/2"(M) for extension

4223-7 5/19.3/20.3/1.4" 3860g

Changed items

	15pc	10; 11; 12; 13; 14; 15; 16; 17; 18; 19; 22; 24; 27; 30; 32 mm
--	------	---

4223-9 5/19.3/20.3/1.4" 3860g

Changed items

	15pc	10; 11; 12; 13; 14; 15; 16; 17; 18; 19; 22; 24; 27; 30; 32 mm
--	------	---

22pc 1/2"DR. Socket combination set

NEW



4226 6/19.4/20.4/0.9" 3230g

	17pc	8; 9; 10; 11; 12; 13; 14; 15; 16; 17; 18; 19; 20; 21; 22; 23; 24 mm
	1pc	QR pear ratchet handle 72teeth (80248)
	2pc	5"(125mm); 10"(250mm)
	1pc	1/2"
	1pc	3/8"(F)x1/2"(M) for extension

4226Q 6/19.4/20.4/0.9" 3230g

Changed items

	17pc	Spline socket 8; 9; 10; 11; 12; 13; 14; 15; 16; 17; 18; 19; 20; 21; 22; 23; 24 mm
--	------	---

24pc 1/2"DR. Socket combination set



4243 4/22.0/23.0/0.9' 5500g

	18pc	10; 11; 12; 13; 14; 15; 16; 17; 18; 19; 20; 21; 22; 23; 24; 27; 30; 32 mm
	1pc	QR thin pear ratchet handle 24teeth (80243)
	1pc	15"(380mm)
	2pc	5"(125mm); 10"(250mm)
	1pc	10"(250mm)
	1pc	1/2"

4243-5 4/22.0/23.0/0.9' 5500g

Changed items

	18pc	10; 11; 12; 13; 14; 15; 16; 17; 18; 19; 20; 21; 22; 23; 24; 27; 30; 32 mm
--	------	---

4243-9 4/22.0/23.0/0.9' 5500g

Changed items

	18pc	10; 11; 12; 13; 14; 15; 16; 17; 18; 19; 20; 21; 22; 23; 24; 27; 30; 32 mm
--	------	---

24pc 1/2"DR. Socket combination set



4245 4/20.7/21.7/0.9' 5175g

	18pc	10; 11; 12; 13; 14; 15; 16; 17; 18; 19; 20; 21; 22; 23; 24; 27; 30; 32 mm
	1pc	QR thin pear ratchet handle 24teeth (80244)
	2pc	5"(125mm); 10"(250mm)
	1pc	10"(250mm)
	1pc	1/2"
	1pc	16.3"(415mm)

4245-7 4/20.7/21.7/0.9' 5175g

Changed items

	18pc	10; 11; 12; 13; 14; 15; 16; 17; 18; 19; 20; 21; 22; 23; 24; 27; 30; 32 mm
--	------	---

4245-9 4/20.7/21.7/0.9' 5175g

Changed items

	18pc	10; 11; 12; 13; 14; 15; 16; 17; 18; 19; 20; 21; 22; 23; 24; 27; 30; 32 mm
--	------	---

24pc 1/2"DR. Socket combination set



4245B 4/20.7/21.7/0.9' 5175g

	18pc	10; 11; 12; 13; 14; 15; 16; 17; 18; 19; 20; 21; 22; 23; 24; 27; 30; 32 mm
	1pc	QR thin pear ratchet handle 24teeth (80244)
	1pc	15"(380mm)
	2pc	5"(125mm); 10"(250mm)
	1pc	10"(250mm)
	1pc	1/2"

4245B-7 4/20.7/21.7/0.9' 5175g

Changed items

	18pc	10; 11; 12; 13; 14; 15; 16; 17; 18; 19; 20; 21; 22; 23; 24; 27; 30; 32 mm
--	------	---

4245B-9 4/20.7/21.7/0.9' 5175g

Changed items

	18pc	10; 11; 12; 13; 14; 15; 16; 17; 18; 19; 20; 21; 22; 23; 24; 27; 30; 32 mm
--	------	---

24pc 1/2"DR. Socket combination set



4246 4/20.6/21.6/0.9' 5150g

	18pc	10; 11; 12; 13; 14; 15; 16; 17; 18; 19; 20; 21; 22; 23; 24; 27; 30; 32 mm
	1pc	Spark plug 20.6mm
	1pc	QR thin pear ratchet handle 24teeth (80243)
	2pc	5"(125mm); 10"(250mm)
	1pc	10"(250mm)
	1pc	1/2"

4246-5 4/20.6/21.6/0.9' 5150g

Changed items

	18pc	10; 11; 12; 13; 14; 15; 16; 17; 18; 19; 20; 21; 22; 23; 24; 27; 30; 32 mm
--	------	---

4246-9 4/20.6/21.6/0.9' 5150g

Changed items

	18pc	10; 11; 12; 13; 14; 15; 16; 17; 18; 19; 20; 21; 22; 23; 24; 27; 30; 32 mm
--	------	---

24pc 1/2"DR. Socket combination set



4246B 4/16.0/17.0/0.87' 4000g

	18pc	10; 11; 12; 13; 14; 15; 16; 17; 18; 19; 20; 21; 22; 23; 24; 27; 30; 32 mm
	1pc	Spark plug 20.6mm
	1pc	QR thin pear ratchet handle 24teeth (80243)
	2pc	5"(125mm); 10"(250mm)
	1pc	10"(250mm)
	1pc	1/2"

4246B-5 4/16.0/17.0/0.87' 4000g

Changed items

	18pc	10; 11; 12; 13; 14; 15; 16; 17; 18; 19; 20; 21; 22; 23; 24; 27; 30; 32 mm
--	------	---

4246B-9 4/16.0/17.0/0.87' 4000g

Changed items

	18pc	10; 11; 12; 13; 14; 15; 16; 17; 18; 19; 20; 21; 22; 23; 24; 27; 30; 32 mm
--	------	---

25pc 1/2"DR. 6pt. Flank socket combination set













4255 4/22.8/23.8/0.91' 5700g

	18pc	10; 11; 12; 13; 14; 15; 16; 17; 18; 19; 20; 21; 22; 23; 24; 27; 30; 32 mm
	1pc	QR pear ratchet handle 36teeth (802433)
	1pc	Adjustable handle (turn-lock design) (8334300)
	2pc	5"(125mm); 10"(250mm)
	1pc	12"(300mm)
	1pc	1/2"
	1pc	105° L handle 12.4"(315mm)

32pc 1/2"DR. 6pt. Flank socket & combination wrench set





4324  4/20.7/21.7/1.2'  5175g











		15pc	8; 10; 12; 13; 14; 15; 16; 17; 18; 19; 22; 24; 27; 30; 32 mm
		2pc	Spark plug 16; 20.6 mm
		1pc	QR thin pear ratchet handle 24teeth (80243)
		2pc	5"(125mm); 10"(250mm)
		1pc	10"(250mm)
		1pc	1/2"
		10pc	10; 12; 13; 14; 15; 16; 17; 18; 19; 22 mm



40pc 1/2"DR. 6pt. Flank & star socket combination set

NEW





4405  3/17.2/18.2/1.2'  5712g

		23pc	8; 9; 10; 11; 12; 13; 14; 15; 16; 17; 18; 19; 20; 21; 22; 23; 24; 25; 26; 27; 28; 30; 32 mm
		10pc	E8; E10; E11; E12; E14; E16; E18; E20; E22; E24
		2pc	Spark plug 16; 20.6 mm
		1pc	QR thin pear ratchet handle 24teeth (80243)
		2pc	5"(125mm); 10"(250mm)
		1pc	10"(250mm)
		1pc	1/2"

4405-4  3/17.2/18.2/1.2'  5712g



Changed items

		1pc	QR thin pear ratchet handle 24teeth (80244)
---	--	-----	---

4405-8  3/17.2/18.2/1.2'  5712g

Changed items

		1pc	QR pear ratchet handle 72teeth (80248)
---	--	-----	--

4405-27  3/17.2/18.2/1.2'  5712g



Changed items











		1pc	QR curved-shank ratchet handle 36teeth (802427)
---	--	-----	---



41pc 1/2"DR. 6pt. Flank socket combination set

NEW





4416  3/19.7/20.7/1.65'  6572g

		20pc	8; 9; 10; 11; 12; 13; 14; 15; 16; 17; 18; 19; 20; 21; 22; 23; 24; 27; 30; 32 mm
		14pc	8; 10; 11; 12; 13; 14; 15; 16; 17; 18; 19; 21; 22; 24 mm (77mmL)
		2pc	Spark plug 16; 20.6 mm
		1pc	QR thin pear ratchet handle 24teeth (80243)
		2pc	5"(125mm); 10"(250mm)
		1pc	10"(250mm)
		1pc	1/2"

4416-4  3/19.7/20.7/1.65'  6572g



Changed items

		1pc	QR thin pear ratchet handle 24teeth (80244)
---	--	-----	---

4416-8  3/19.7/20.7/1.65'  6572g

Changed items

		1pc	QR pear ratchet handle 72teeth (80248)
---	--	-----	--

4416-27  3/19.7/20.7/1.65'  6572g



Changed items













		1pc	QR curved-shank ratchet handle 36teeth (802427)
---	--	-----	---

44pc 1/2"DR. 6pt. Flank & star socket combination set

NEW



4445  3/20.2/21.2/0.8'  6732g

		18pc	10; 11; 12; 13; 14; 15; 16; 17; 18; 19; 20; 21; 22; 23; 24; 27; 30; 32 mm
		10pc	E8; E10; E11; E12; E14; E16; E18; E20; E22; E24
		2pc	Spark plug 16; 20.6 mm
		9pc	T20; T25; T27; T30; T40; T45; T50; T55; T60 (55mmL)
		1pc	QR pear ratchet handle 72teeth (80248)
		2pc	5"(125mm); 10"(250mm)
		1pc	10"(250mm)
		1pc	1/2"

53pc 1/4" & 1/2" Socket combination set



4541 4/20.0/21.0/0.9' 5000g

1/4"DR. Part	
	9pc 4; 5; 5.5; 6; 7; 8; 9; 10; 11 mm
	3pc PH.1; PH.2; PH.3 (32mmL)
	3pc 4; 5.5; 7 mm (32mmL)
	4pc 3; 4; 5; 6 mm (32mmL)
	6pc T10; T20; T25; T27; T30; T40 (32mmL)
	1pc QR pear ratchet handle 24teeth (80222)
	2pc 2"(50mm); 6"(150mm)
	1pc 1/4"
	1pc 4"(100mm)
1/2"DR. Part	
	12pc 10; 11; 12; 13; 14; 15; 17; 20; 22; 24; 30; 32 mm
	2pc Spark plug 16; 20.6 mm
	1pc QR pear ratchet handle 24teeth (80242)
	2pc 5"(125mm); 10"(250mm)
	1pc 1/2"
	1pc 3/8"(F)x1/2"(M) for extension
Others	
	4pc 1.27; 1.5; 2; 2.5 mm

4541-5 4/20.0/21.0/0.9' 5000g

Changed items	
	9pc 1/4"DR. 4; 5; 5.5; 6; 7; 8; 9; 10; 11 mm
	12pc 1/2"DR. 10; 11; 12; 13; 14; 15; 17; 20; 22; 24; 30; 32 mm

4541-7 4/20.0/21.0/0.9' 5000g

Changed items	
	9pc 1/4"DR. 4; 5; 5.5; 6; 7; 8; 9; 10; 11 mm
	12pc 1/2"DR. 10; 11; 12; 13; 14; 15; 17; 20; 22; 24; 30; 32 mm

62pc 1/2"DR. Socket, L key and combination wrench set



4622 3/21.6/22.6/1.65' 7200g

	18pc 10; 11; 12; 13; 14; 15; 16; 17; 18; 19; 20; 21; 22; 23; 24; 27; 30; 32 mm
	2pc Spark plug 16; 20.6 mm
	1pc QR thin pear ratchet handle 24teeth (80243)
	2pc 5"(125mm); 10"(250mm)
	1pc 1/2"
	1pc 3/8"DR.x1/2"(M) for extension
	17pc 6; 7; 8; 9; 10; 11; 12; 13; 14; 15; 16; 17; 18; 19; 21; 22; 24 mm
	9pc T10; T15; T20; T25; T27; T30; T40; T45; T50 (5098XL)
	11pc 1.5; 2; 2.5; 3; 4; 5; 6; 7; 8; 10; 12 mm (5116XLB)

4622-4 3/21.6/22.6/1.65' 7200g

Changed items	
	1pc QR thin pear ratchet handle 24teeth (80244)

4622-8 3/21.6/22.6/1.65' 7200g

Changed items	
	1pc QR pear ratchet handle 72teeth (80248)

4622-27 3/21.6/22.6/1.65' 7200g

Changed items	
	1pc QR curved-shank ratchet handle 36teeth (802427)

65pc 1/4" & 1/2" Combination set



4653 2/20.9/21.9/1.5' 10.4kg

1/4"DR. Part	
	10pc 5.5; 6; 7; 8; 9; 10; 11; 12; 13; 14 mm
	1pc QR pear ratchet handle 24teeth (80222)
	2pc 2"(50mm); 4"(100mm)
	1pc 4.5"(115mm)
	1pc 1/4"
	1pc 6"(150mm) with 1/4"DR.(F)
1/2"DR. Part	
	13pc 8; 10; 12; 13; 14; 15; 17; 19; 22; 24; 27; 30; 32 mm
	2pc Spark plug 16; 20.6 mm
	1pc QR pear ratchet handle 36teeth (802415)
	1pc 15"(380mm)
	2pc 5"(125mm); 10"(250mm)
	1pc 12"(300mm)
	1pc 1/2"
Others	
	1pc 7"(175mm)
	1pc 4.7"(118mm)
	1pc 10"(250mm)
	1pc 500gw
	1pc PH.2 (25mmL)
	2pc PH.1 (80mmL); PH.2 (100mmL)
	1pc 5.5mm (25mmL)
	2pc 5.5mm (125mmL); 6.5mm (150mmL)
	4pc 8x10; 12x13; 14x15; 17x19 mm
	10pc 6; 8; 10; 12; 13; 14; 15; 17; 19; 22 mm
	4pc 6; 8; 10; 12 mm

68pc 1/4" & 1/2" Socket combination set



4682

5/24.0/25.0/1.4' 4800g

1/4"DR. Part	
	13pc 4; 4.5; 5; 5.5; 6; 7; 8; 9; 10; 11; 12; 13; 14 mm
	3pc PH.1; PH.2; PH.3 (32mmL)
	3pc PZ.1; PZ.2; PZ.3 (32mmL)
	3pc 4; 5.5; 7 mm (32mmL)
	6pc 3; 4; 5; 6; 7; 8 mm (32mmL)
	7pc T8; T10; T15; T20; T25; T27; T30 (32mmL)
	1pc QR pear ratchet handle 24teeth (80222)
	2pc 2"(50mm); 4"(100mm)
	1pc 4.5"(115mm)
	1pc 1/4"
	1pc Flexible extension 5.8"(145mm)
	1pc 6"(150mm) with 1/4"DR.(F)

1/2"DR. Part	
	15pc 10; 11; 12; 13; 14; 15; 16; 17; 18; 19; 22; 24; 27; 30; 32 mm
	2pc Spark plug 16; 20.6 mm
	1pc QR pear ratchet handle 24teeth (80242)
	2pc 5"(125mm); 10"(250mm)
	1pc 1/2"
	1pc 3/8"(F)x1/2"(M) for extension

Others	
	4pc 1.27; 1.5; 2; 2.5 mm

4682-5

5/24.0/25.0/1.4' 4800g

Changed items	
	13pc 1/4"DR. 4; 4.5; 5; 5.5; 6; 7; 8; 9; 10; 11; 12; 13; 14 mm
	15pc 1/2"DR. 10; 11; 12; 13; 14; 15; 16; 17; 18; 19; 22; 24; 27; 30; 32 mm

4682-9

5/24.0/25.0/1.4' 4800g

Changed items	
	13pc 1/4"DR. 4; 4.5; 5; 5.5; 6; 7; 8; 9; 10; 11; 12; 13; 14 mm
	15pc 1/2"DR. 10; 11; 12; 13; 14; 15; 16; 17; 18; 19; 22; 24; 27; 30; 32 mm

77pc 1/4" & 1/2" Combination set



4772

3/17.0/18.0/1' 5666g

1/4"DR. Part	
	9pc 4; 5; 6; 7; 8; 9; 10; 11; 12 mm
	1pc QR pear ratchet handle 24teeth (80222)
	1pc 4"(100mm)
	1pc 4.5"(115mm)
	1pc 1/4"
	1pc 1/4"DR.x1/4"(F)

1/2"DR. Part	
	13pc 10; 11; 12; 13; 14; 15; 17; 19; 22; 24; 27; 30; 32 mm
	1pc Spark plug 20.6mm
	1pc QR thin pear ratchet handle 24teeth (80243)
	2pc 5"(125mm); 10"(250mm)
	1pc 1/2"

Bits	
	4pc 1/4" PH.0; PH.1; PH.2; PH.3 (30mmL)
	3pc 1/4" PZ.1; PZ.2; PZ.3 (30mmL)
	4pc 1/4" 3; 4; 5.5; 6.5 mm (30mmL)
	5pc 1/4" 2; 3; 4; 5; 6 mm (30mmL)
	6pc 1/4" T8; T10; T15; T20; T25; T30 (30mmL)
	1pc 1/4"Hex-1/4"Sq. (30mmL)

Others	
	4pc 8x9; 10x11; 12x13; 14x15 mm
	11pc 7; 8; 9; 10; 11; 12; 13; 14; 15; 17; 19 mm
	7pc 2.5; 3; 4; 5; 6; 8; 10 mm (5072)

82pc 1/4" & 1/2" Combination set



4821

3/18.0/19.0/1' 6000g

1/4"DR. Part	
	13pc 4; 4.5; 5; 5.5; 6; 7; 8; 9; 10; 11; 12; 13; 14 mm
	2pc PH.1; PH.2 (32mmL)
	2pc PZ.1; PZ.2 (32mmL)
	3pc 4; 5.5; 6.5 mm (32mmL)
	4pc 3; 4; 5; 6 mm (32mmL)
	6pc T8; T10; T15; T20; T25; T30 (32mmL)
	1pc QR pear ratchet handle 24teeth (80222)
	2pc 2"(50mm); 4"(100mm)
	1pc 4.5"(115mm)
	1pc 1/4"
	1pc Flexible extension 5.8"(145mm)
	1pc 6"(150mm) with 1/4"DR.(F)

1/2"DR. Part	
	12pc 14; 15; 16; 17; 18; 19; 20; 22; 24; 27; 30; 32 mm
	2pc Spark plug 16; 20.6 mm
	1pc QR thin pear ratchet handle 24teeth (80243)
	2pc 5"(125mm); 10"(250mm)
	1pc 1/2"
	1pc 3/8"(F)x1/2"(M) for extension
	1pc 1/2"DR.x5/16"(F)

Bits	
	2pc 5/16" PH.3; PH.4 (30mmL)
	2pc 5/16" PZ.3; PZ.4 (30mmL)
	3pc 5/16" 8; 10; 12 mm (30mmL)
	4pc 5/16" 8; 10; 12; 14 mm (30mmL)
	4pc 5/16" T40; T45; T50; T55 (30mmL)
	1pc 1/4"Hex-1/4"Sq. (25mmL)

Others	
	9pc 8; 10; 11; 12; 13; 14; 17; 19; 22 mm

4821-5

3/18.0/19.0/1' 6000g

Changed items	
	13pc 1/4"DR. 4; 4.5; 5; 5.5; 6; 7; 8; 9; 10; 11; 12; 13; 14 mm
	12pc 1/2"DR. 14; 15; 16; 17; 18; 19; 20; 22; 24; 27; 30; 32 mm

4821-9

3/18.0/19.0/1' 6000g

Changed items	
	13pc 1/4"DR. 4; 4.5; 5; 5.5; 6; 7; 8; 9; 10; 11; 12; 13; 14 mm
	12pc 1/2"DR. 14; 15; 16; 17; 18; 19; 20; 22; 24; 27; 30; 32 mm

91pc 1/4" & 1/2" Combination set



4911

2/20.0/21.0/1.54' 10000g

1/4"DR. Part	
	12pc 4; 4.5; 5; 5.5; 6; 7; 8; 9; 10; 11; 12; 13 mm
	1pc QR pear ratchet handle 24teeth (80222)
	2pc 2"(50mm); 4"(100mm)
	1pc 4.5"(115mm)
	1pc 1/4"
	1pc 1/4"DR.x1/4"(F)
	1pc Flexible extension 5.8"(145mm)
	1pc Magnetic socket pick-up (25mmL)
	1pc 6"(150mm) with 1/4"DR.(F)

1/2"DR. Part	
	12pc 8; 10; 12; 13; 14; 15; 16; 17; 18; 19; 20; 21 mm
	5pc 22; 24; 27; 30; 32 mm (77mmL)
	2pc Spark plug 16; 20.6 mm
	1pc QR thin pear ratchet handle 24teeth (80243)
	1pc 15"(380mm)
	1pc 10"(250mm)
	2pc Wobble extension 2"(50mm); 5"(125mm)
	1pc 1/2"
	1pc 3/8"(F)x1/2"(M) for extension

Bits	
	4pc 1/4" PH.0; PH.1; PH.2; PH.3 (30mmL)
	3pc 1/4" PZ.1; PZ.2; PZ.3 (30mmL)
	2pc 1/4" 5.5; 7 mm (30mmL)
	8pc 1/4" 2; 3; 4; 5; 6; 7; 8; 10 mm (30mmL)
	7pc 1/4" T-10H; T-15H; T-20H; T-25H; T-27H; T-30H; T-40H (30mmL)

Others	
	1pc 15 (180mmL)
	1pc 6 (210mmL)
	1pc 8"(200mm)
	1pc 7"(175mm)
	1pc 10"(250mm)
	1pc 300gw
	1pc PH.1 (25mmL)
	1pc PH.2 (100mmL)
	1pc 5.5mm (25mmL)
	1pc 6.5mm (150mmL)
	10pc 6; 8; 10; 12; 13; 14; 15; 17; 19; 22 mm

4911-9

2/20.0/21.0/1.54' 10000g

Changed items	
	12pc 1/4"DR. 4; 4.5; 5; 5.5; 6; 7; 8; 9; 10; 11; 12; 13 mm
	12pc 1/2"DR. 8; 10; 12; 13; 14; 15; 16; 17; 18; 19; 20; 21 mm
	5pc 1/2"DR. 22; 24; 27; 30; 32 mm (77mmL)

94pc 1/4" & 1/2" Socket combination set



4941

3/21.0/22.0/1' 7000g

1/4"DR. Part	
	13pc 4; 4.5; 5; 5.5; 6; 7; 8; 9; 10; 11; 12; 13; 14 mm
	8pc 6; 7; 8; 9; 10; 11; 12; 13 mm (50mmL)
	2pc PH.1; PH.2 (32mmL)
	2pc PZ.1; PZ.2 (32mmL)
	3pc 4; 5.5; 6.5 mm (32mmL)
	4pc 3; 4; 5; 6 mm (32mmL)
	7pc T8; T10; T15; T20; T25; T27; T30 (32mmL)
	1pc QR pear ratchet handle 24teeth (80222)
	2pc 2"(50mm); 4"(100mm)
	1pc 4.5"(115mm)
	1pc 1/4"
	1pc 6"(150mm) with 1/4"DR.(F)

1/2"DR. Part	
	17pc 10; 11; 12; 13; 14; 15; 16; 17; 18; 19; 20; 21; 22; 24; 27; 30; 32 mm
	5pc 14; 15; 17; 19; 22 mm (77mmL)
	2pc Spark plug 16; 20.6 mm
	1pc QR pear ratchet handle 24teeth (80242)
	2pc 5"(125mm); 10"(250mm)
	1pc 1/2"
	1pc 3/8"(F)x1/2"(M) for extension
	1pc 1/2"DR.x5/16"(F)

Bits	
	2pc 5/16" PH.3; PH.4 (30mmL)
	2pc 5/16" PZ.3; PZ.4 (30mmL)
	3pc 5/16" 8; 10; 12 mm (30mmL)
	5pc 5/16" 7; 8; 10; 12; 14 mm (30mmL)
	4pc 5/16" T40; T45; T50; T55 (30mmL)

Others	
	3pc 1.5; 2; 2.5 mm

4941-5

3/21.0/22.0/1' 7000g

Changed items	
	13pc 1/4"DR. 4; 4.5; 5; 5.5; 6; 7; 8; 9; 10; 11; 12; 13; 14 mm
	17pc 1/2"DR. 10; 11; 12; 13; 14; 15; 16; 17; 18; 19; 20; 21; 22; 24; 27; 30; 32 mm
	8pc 1/4"DR. 6; 7; 8; 9; 10; 11; 12; 13 mm (50mmL)
	5pc 1/2"DR. 14; 15; 17; 19; 22 mm (77mmL)

4941-9

3/21.0/22.0/1' 7000g

Changed items	
	13pc 1/4"DR. 4; 4.5; 5; 5.5; 6; 7; 8; 9; 10; 11; 12; 13; 14 mm
	17pc 1/2"DR. 10; 11; 12; 13; 14; 15; 16; 17; 18; 19; 20; 21; 22; 24; 27; 30; 32 mm
	8pc 1/4"DR. 6; 7; 8; 9; 10; 11; 12; 13 mm (50mmL)
	5pc 1/2"DR. 14; 15; 17; 19; 22 mm (77mmL)

102pc 1/4" & 1/2" Combination set



41021

2/19.5/20.5/1.54' 9750g

1/4"DR. Part	
	9pc 4; 4.5; 5; 5.5; 6; 7; 8; 9; 10 mm
	6pc E4; E5; E6; E7; E8; E10
	1pc QR pear ratchet handle 24teeth (80222)
	2pc 4"(100mm); 6"(150mm)
	1pc 4.5"(115mm)
	1pc 1/4"
	1pc 1/4"DR.x1/4"(F)
	1pc Flexible extension 5.8"(145mm)
	1pc 6"(150mm) with 1/4"DR.(F)

1/2"DR. Part	
	20pc 8; 9; 10; 11; 12; 13; 14; 15; 16; 17; 18; 19; 20; 21; 22; 23; 24; 27; 30; 32 mm
	5pc E10; E12; E14; E16; E18
	2pc Spark plug 16; 20.6 mm
	1pc QR thin pear ratchet handle 24teeth (80243)
	2pc 5"(125mm); 10"(250mm)
	1pc Wobble extension 2"(50mm)
	1pc 10"(250mm)
	1pc 1/2"

Bits	
	10pc 1/4" 2; 2.5; 3; 4; 5; 5.5; 6; 7; 8; 10 mm (25mmL)
	11pc 1/4" T-6H; T-7H; T-8H; T-9H; T-10H; T-15H; T-20H; T-25H; T-27H; T-30H; T-40H (25mmL)

Others	
	1pc 7"(175mm)
	1pc Multi-function magnetic pick-up
	1pc 8"(200mm)
	2pc Hammer PH.1 (80mmL); PH.2 (100mmL)
	2pc Hammer 5.5mm (125mmL); 6.5mm (150mmL)
	4pc 8x10; 11x13; 12x14; 17x19 mm
	14pc 8; 10; 11; 12; 13; 14; 15; 16; 17; 18; 19; 21; 22; 24 mm

41021-9

2/19.5/20.5/1.54' 9750g

Changed items	
	9pc 1/4"DR. 4; 4.5; 5; 5.5; 6; 7; 8; 9; 10 mm
	20pc 1/2"DR. 8; 9; 10; 11; 12; 13; 14; 15; 16; 17; 18; 19; 20; 21; 22; 23; 24; 27; 30; 32 mm

107pc 1/4" & 1/2" Combination set



41071

2/22.4/23.4/1.54' 11.2kg

1/4"DR. Part	
	12pc 4; 4.5; 5; 5.5; 6; 7; 8; 9; 10; 11; 12; 13 mm
	1pc QR pear ratchet handle 24teeth (80222)
	2pc 2"(50mm); 4"(100mm)
	1pc 4.5"(115mm)
	1pc 1/4"
	1pc 1/4"DR.x1/4"(F)
	1pc Flexible extension 5.8"(145mm)
	1pc Magnetic socket pick-up (25mmL)
	1pc 6"(150mm) with 1/4"DR.(F)

1/2"DR. Part	
	12pc 8; 10; 12; 13; 14; 15; 16; 17; 18; 19; 20; 21 mm
	5pc 22; 24; 27; 30; 32 mm (77mmL)
	2pc Spark plug 16; 20.6 mm
	1pc QR thin pear ratchet handle 24teeth (80243)
	1pc 15"(380mm)
	1pc 10"(250mm)
	2pc Wobble extension 2"(50mm); 5"(125mm)
	1pc 1/2"
	1pc 3/8"(F)x1/2"(M) for extension

Bits	
	4pc 1/4" PH.0; PH.1; PH.2; PH.3 (30mmL)
	3pc 1/4" PZ.1; PZ.2; PZ.3 (30mmL)
	2pc 1/4" 5.5; 7 mm (30mmL)
	8pc 1/4" 2; 3; 4; 5; 6; 7; 8; 10 mm (30mmL)
	7pc 1/4" T-10H; T-15H; T-20H; T-25H; T-27H; T-30H; T-40H (30mmL)

Others	
	1pc 15 (180mmL)
	1pc 7"(175mm)
	1pc 10"(250mm)
	1pc 300gw
	1pc 20pc Blade feeler gauge (618)
	5pc 8x10; 10x12; 11x13; 12x14; 17x19 mm
	16pc 6; 7; 8; 9; 10; 11; 12; 13; 14; 15; 16; 17; 18; 19; 21; 22 mm
	10pc 2.5; 3; 4; 5; 6; 7; 8; 10; 12; 14 mm

41071-9

2/22.4/23.4/1.54' 11.2kg

Changed items	
	12pc 1/4"DR. 4; 4.5; 5; 5.5; 6; 7; 8; 9; 10; 11; 12; 13 mm
	12pc 1/2"DR. 8; 10; 12; 13; 14; 15; 16; 17; 18; 19; 20; 21 mm
	5pc 1/2"DR. 22; 24; 27; 30; 32 mm (77mmL)

108pc 1/4" & 1/2" Socket combination set



41082

3/22.8/23.8/1.7' 7600g

1/4"DR. Part	
	13pc 4; 4.5; 5; 5.5; 6; 7; 8; 9; 10; 11; 12; 13; 14 mm
	8pc 6; 7; 8; 9; 10; 11; 12; 13 mm (50mmL)
	5pc E4; E5; E6; E7; E8
	2pc PH.1; PH.2 (32mmL)
	2pc PZ.1; PZ.2 (32mmL)
	3pc 4; 5.5; 6.5 mm (32mmL)
	4pc 3; 4; 5; 6 mm (32mmL)
	7pc T8; T10; T15; T20; T25; T27; T30 (32mmL)
	1pc QR pear ratchet handle 24teeth (80222)
	2pc 2"(50mm); 4"(100mm)
	1pc 4.5"(115mm)
	1pc 1/4"
	1pc 6"(150mm) with 1/4"DR.(F)

1/2"DR. Part	
	17pc 10; 11; 12; 13; 14; 15; 16; 17; 18; 19; 20; 21; 22; 24; 27; 30; 32 mm
	5pc 14; 15; 17; 19; 22 mm (77mmL)
	8pc E10; E11; E12; E14; E16; E18; E20; E24
	2pc Spark plug 16; 20.6 mm
	1pc QR pear ratchet handle 24teeth (80242)
	1pc 10"(250mm)
	1pc Wobble extension 5"(125mm)
	1pc 1/2"
	1pc 3/8"(F)x1/2"(M) for extension
	1pc 1/2"DR.x5/16"(F)

Bits	
	2pc 5/16" PH.3; PH.4 (30mmL)
	2pc 5/16" PZ.3; PZ.4 (30mmL)
	3pc 5/16" 8; 10; 12 mm (30mmL)
	5pc 5/16" 7; 8; 10; 12; 14 mm (30mmL)
	5pc 5/16" T40; T45; T50; T55; T60 (30mmL)

Others	
	3pc 1.5; 2; 2.5 mm

41082-9

3/22.8/23.8/1.7' 7600g

Changed items	
	13pc 1/4"DR. 4; 4.5; 5; 5.5; 6; 7; 8; 9; 10; 11; 12; 13; 14 mm
	17pc 1/2"DR. 10; 11; 12; 13; 14; 15; 16; 17; 18; 19; 20; 21; 22; 24; 27; 30; 32 mm
	8pc 1/4"DR. 6; 7; 8; 9; 10; 11; 12; 13 mm (50mmL)
	5pc 1/2"DR. 14; 15; 17; 19; 22 mm (77mmL)

110pc 1/4" & 1/2" Combination set



41101

2/20.9/21.9/1.5' 10.4kg

1/4"DR. Part	
	10pc 4; 5; 6; 7; 8; 9; 10; 11; 12; 13 mm
	1pc QR pear ratchet handle 24teeth (80222)
	2pc 2"(50mm); 4"(100mm)
	1pc 1/4"
	1pc 1/4"DR.x1/4"(F)
	1pc Flexible extension 5.8"(145mm)
	1pc 6"(150mm) with 1/4"DR.(F)

1/2"DR. Part	
	18pc 10; 11; 12; 13; 14; 15; 16; 17; 18; 19; 20; 21; 22; 23; 24; 27; 30; 32 mm
	8pc E10; E11; E12; E14; E16; E18; E20; E24
	2pc Spark plug 16; 20.6 mm
	1pc QR thin pear ratchet handle 24teeth (80243)
	1pc 15"(380mm)
	2pc 3"(75mm); 10"(250mm)
	1pc 1/2"
	1pc 1/2"DR.x5/16"(F)

Bits	
	3pc 1/4" PH.0; PH.1; PH.2 (30mmL)
	2pc 5/16" PH.3; PH.4 (30mmL)
	2pc 1/4" PZ.1; PZ.2 (30mmL)
	2pc 5/16" PZ.3; PZ.4 (30mmL)
	4pc 1/4" 3; 4; 5.5; 6.5 mm (30mmL)
	3pc 5/16" 8; 10; 12 mm (30mmL)
	4pc 1/4" 3; 4; 5; 6 mm (30mmL)
	5pc 5/16" 7; 8; 10; 12; 14 mm (70mmL)
	7pc 1/4" T8; T10; T15; T20; T25; T27; T30 (30mmL)
	4pc 5/16" T40; T45; T50; T55 (30mmL)

Others	
	1pc 7"(175mm)
	1pc 10"(250mm)
	1pc 300gw
	1pc PH.2 (25mmL)
	1pc PH.2 (100mmL)
	1pc 6.5mm (25mmL)
	1pc 6.5mm (150mmL)
	16pc 6; 7; 8; 9; 10; 11; 12; 13; 14; 15; 16; 17; 19; 22; 24; 27 mm

118pc 1/4" & 1/2" Combination set

NEW



41182

2/24.6/25.6/2.2' 12.3kg

1/4"DR. Part	
	12pc 4; 4.5; 5; 5.5; 6; 7; 8; 9; 10; 11; 12; 13 mm
	6pc 7; 8; 9; 10; 11; 12 mm (50mmL)
	4pc PH.0; PH.1; PH.2; PH.3 (32mmL)
	2pc PZ.1; PZ.2 (32mmL)
	3pc 4; 5.5; 6.5 mm (32mmL)
	7pc 3; 4; 5; 6; 7; 8; 10 mm (32mmL)
	7pc T10; T15; T20; T25; T27; T30; T40 (32mmL)
	7pc T-10H; T-15H; T-20H; T-25H; T-27H; T-30H; T-40H (32mmL)
	1pc QR pear ratchet handle 72teeth (80228)
	2pc 2"(50mm); 4"(100mm)
	1pc 1/4"
	1pc 3/8"(F)x1/4"(M) for extension
	1pc 6"(150mm) with 1/4"DR.(F)

1/2"DR. Part	
	18pc 10; 11; 12; 13; 14; 15; 16; 17; 18; 19; 20; 21; 22; 23; 24; 27; 30; 32 mm
	10pc 13; 14; 15; 16; 17; 18; 19; 21; 22; 24 mm (77mmL)
	2pc Spark plug 16; 20.6 mm
	1pc QR thin pear ratchet handle 24teeth (80243)
	2pc 5"(125mm); 10"(250mm)
	1pc 1/2"
	1pc 3/8"(F)x1/2"(M) for extension
	1pc 1/2"DR.x10mm(F)

Bits	
	3pc 10mm 10; 12; 14 mm (30mmL)
	4pc 10mm T40; T45; T50; T55 (30mmL)

Others	
	2pc 12 (150mmL); 19 (200mmL)
	6pc 2 (140mmL); 3 (150mmL); 4 (190mmL); 5 (200mmL); 6 (210mmL); 8 (215mmL) (50613)
	1pc 4 (185mmL)
	1pc 7"(175mm)
	1pc 7"(175mm)
	1pc 10"(250mm)
	1pc 300gw
	2pc 8"(200mm); 12"(300mm)
	2pc PH.1 (80mmL); PH.2 (100mmL)
	4pc 3mm (75mmL); 4mm (100mmL); 5.5mm (125mmL); 6.5mm (150mmL)

41182-27

2/24.6/25.6/2.2' 12.3kg

Changed items	
	1pc 1/4"DR. QR curved-shank ratchet handle 36teeth (802227)
	1pc 1/2"DR. QR curved-shank ratchet handle 36teeth (802427)

131pc 1/4" & 1/2" Socket combination set

NEW



41311

3/23.7/24.7/1.65' 7898g

1/4"DR. Part	
	12pc 4; 4.5; 5; 5.5; 6; 7; 8; 9; 10; 11; 12; 13 mm
	7pc 6; 7; 8; 9; 10; 11; 12 mm (50mmL)
	4pc PH.0; PH.1; PH.2; PH.3 (32mmL)
	2pc PZ.1; PZ.2 (32mmL)
	4pc 4; 5.5; 6.5; 7 mm (32mmL)
	6pc 3; 4; 5; 6; 7; 8 mm (32mmL)
	7pc T8; T10; T15; T20; T25; T27; T30 (32mmL)
	7pc T-10H; T-15H; T-20H; T-25H; T-27H; T-30H; T-40H (32mmL)
	1pc QR pear ratchet handle 72teeth (80228)
	3pc 2"(50mm); 4"(100mm); 6"(150mm)
	1pc 1/4"
	1pc 3/8"(F)x1/4"(M) for extension
	1pc 1/4"DR.x1/4"(F)
	1pc 6"(150mm) with 1/4"DR.(F)

1/2"DR. Part	
	18pc 10; 11; 12; 13; 14; 15; 16; 17; 18; 19; 20; 21; 22; 23; 24; 27; 30; 32 mm
	10pc 13; 14; 15; 16; 17; 18; 19; 21; 22; 24 mm (77mmL)
	2pc Spark plug 16; 20.6 mm
	3pc 10; 12 mm (55mmL); 14 mm (65mmL)
	4pc T40; T45; T50; T55 (55mmL)
	1pc QR thin pear ratchet handle 24teeth (80243)
	2pc 5"(125mm); 10"(250mm)
	1pc 1/2"
	1pc 3/8"(F)x1/2"(M) for extension

Bits	
	6pc 1/4" 2; 4; 6; 8; 10 mm (25mmL) 1/4" (25mmL)
	4pc 1/4" 1; 2; 3; 4 (25mmL)
	6pc 1/4" 4; 6; 8; 10; 12; 14 mm (25mmL)
	4pc 1/4" No.0; No.1; No.2; No.3 (25mmL)
	6pc 1/4" 2; 2.5; 3; 4; 5; 6 mm (25mmL)
	6pc 1/4" 5/64"; 3/32"; 7/64"; 1/8"; 9/64"; 5/32" (25mmL)

41311-27

3/23.7/24.7/1.65' 7898g

Changed items	
	1pc 1/4"DR. QR curved-shank ratchet handle 36teeth (802227)
	1pc 1/2"DR. QR curved-shank ratchet handle 36teeth (802427)

139pc 1/4" & 1/2" Combination set



41391

2/22.6/23.6/1.54' 11.3Kg

1/4"DR. Part			
	10pc	4; 5; 6; 7; 8; 9; 10; 11; 12; 13 mm	
	1pc	QR pear ratchet handle 24teeth (80222)	
	2pc	2"(50mm); 4"(100mm)	
	1pc	4.5"(115mm)	
	1pc	1/4"	
	1pc	1/4"DR.x1/4"(F)	
	1pc	Flexible extension 5.8"(145mm)	
	1pc	6"(150mm) with 1/4"DR.(F)	
1/2"DR. Part			
	18pc	10; 11; 12; 13; 14; 15; 16; 17; 18; 19; 20; 21; 22; 23; 24; 27; 30; 32 mm	
	2pc	Spark plug 16; 20.6 mm	
	1pc	QR thin pear ratchet handle 24teeth (80243)	
	1pc	15"(380mm)	
	2pc	3"(75mm); 10"(250mm)	
	1pc	1/2"	
	1pc	1/2"DR.x5/16"(F)	
Bits			
	3pc	1/4" PH.0; PH.1; PH.2 (30mmL)	
	2pc	5/16" PH.3; PH.4 (30mmL)	
	2pc	1/4" PZ.1; PZ.2 (30mmL)	
	2pc	5/16" PZ.3; PZ.4 (30mmL)	
	3pc	1/4" 4; 5.5; 6.5 mm (30mmL)	
	3pc	5/16" 8; 10; 12 mm (30mmL)	
	5pc	1/4" 3; 4; 5; 6; 8 mm (30mmL)	
	7pc	5/16" 4; 5; 6; 7; 8; 10; 12 mm (70mmL)	
	7pc	1/4" T8; T10; T15; T20; T25; T27; T30 (30mmL)	
	4pc	5/16" T40; T45; T50; T55 (30mmL)	
Others			
	2pc	19 (200mmL); 25 (220mmL)	
	4pc	2 (140mmL); 3 (150mmL); 4 (190mmL); 5 (200mmL)	
	1pc	4 (185mmL)	
	1pc	7"(175mm)	
	1pc	10"(250mm)	
	1pc	300gw	
	1pc	Multi-purpose crimping tool	
	26pc	Terminal pack	
	1pc	PH.2 (25mmL)	
	1pc	PH.2 (100mmL)	
	1pc	6.5mm (25mmL)	
	1pc	6.5mm (150mmL)	
	16pc	6; 7; 8; 9; 10; 11; 12; 13; 14; 15; 16; 17; 19; 22; 24; 27 mm	

142pc 1/4" & 3/8" & 1/2" Combination set



41421

2/26.0/27.0/1.54' 13kg

1/4"DR. Part			
	9pc	4; 4.5; 5; 5.5; 6; 7; 8; 9; 10 mm	
	5pc	E4; E5; E6; E7; E8	
	1pc	QR pear ratchet handle 24teeth (80222)	
	3pc	2"(50mm); 4"(100mm); 6"(150mm)	
	1pc	1/4"	
	1pc	3/8"(F)x1/4"(M) for extension	
	1pc	1/4"DR.x1/4"(F)	
	1pc	Flexible extension 5.8"(145mm)	
	1pc	6"(150mm) with 1/4"DR.(F)	
3/8"DR. Part			
	15pc	6; 7; 8; 9; 10; 11; 12; 13; 14; 15; 17; 18; 19; 21; 22 mm	
	1pc	QR flexible ratchet handle 30teeth (802318)	
	2pc	3"(75mm); 6"(150mm)	
	1pc	3/8"	
1/2"DR. Part			
	19pc	8; 10; 12; 13; 14; 15; 16; 17; 18; 19; 20; 21; 22; 23; 24; 25; 27; 30; 32 mm	
	5pc	E10; E12; E14; E16; E20	
	2pc	Spark plug 16; 20.6 mm	
	1pc	QR thin pear ratchet handle 24teeth (80243)	
	1pc	17"(430mm)	
	2pc	3"(75mm); 10"(250mm)	
	1pc	1/2"	
	1pc	3/8"(F)x1/2"(M) for extension	
	1pc	10.2"(260mm)	
Bits			
	4pc	1/4" PH.0; PH.1; PH.2; PH.3 (30mmL)	
	4pc	1/4" PZ.0; PZ.1; PZ.2; PZ.3 (30mmL)	
	3pc	1/4" 4; 5.5; 7 mm (30mmL)	
	8pc	1/4" 2; 3; 4; 5; 6; 7; 8; 10 mm (30mmL)	
	7pc	1/4" T-10H; T-15H; T-20H; T-25H; T-27H; T-30H; T-40H (30mmL)	

Others			
	1pc	7"(175mm)	
	1pc	10"(250mm)	
	1pc	300gw	
	1pc	PH.1 (25mmL)	
	1pc	PH.2 (100mmL)	
	1pc	5.5mm (25mmL)	
	1pc	6.5mm (150mmL)	
	1pc	Hammer 6.5mm (150mmL)	
	5pc	8x10; 10x12; 11x13; 12x14; 17x19 mm	
	17pc	6; 7; 8; 9; 10; 11; 12; 13; 14; 15; 16; 17; 18; 19; 21; 22; 24 mm	
	10pc	2.5; 3; 4; 5; 6; 7; 8; 10; 12; 14 mm	

41421-9

2/26.0/27.0/1.54' 13kg

Changed items			
	9pc	1/4"DR. 4; 4.5; 5; 5.5; 6; 7; 8; 9; 10 mm	
	19pc	1/2"DR. 8; 10; 12; 13; 14; 15; 16; 17; 18; 19; 20; 21; 22; 23; 24; 25; 27; 30; 32 mm	

180pc 1/4" & 3/8" & 1/2" Socket combination set

NEW



41801 2/23.0/24.0/2.2' 11.5kg

1/4"DR. Part			
	12pc	4; 4.5; 5; 5.5; 6; 7; 8; 9; 10; 11; 12; 13 mm	
	5pc	6; 7; 8; 9; 10 mm (50mmL)	
	5pc	E4; E5; E6; E7; E8	
	4pc	PH.0; PH.1; PH.2; PH.3 (32mmL)	
	2pc	PZ.1; PZ.2 (32mmL)	
	3pc	4; 5.5; 6.5 mm (32mmL)	
	4pc	3; 4; 5; 6 mm (32mmL)	
	7pc	T8; T10; T15; T20; T25; T27; T30 (32mmL)	
	7pc	T-10H; T-15H; T-20H; T-25H; T-27H; T-30H; T-40H (32mmL)	
	1pc	QR pear ratchet handle 72teeth (80228)	
	3pc	2"(50mm); 4"(100mm); 6"(150mm)	
	1pc	1/4"	
	1pc	3/8"(F)x1/4"(M) for extension	
	1pc	1/4"DR.x1/4"(F)	
	1pc	6"(150mm) with 1/4"DR.(F)	

3/8"DR. Part			
	10pc	10; 11; 12; 13; 14; 15; 16; 17; 18; 19 mm	
	7pc	11; 12; 13; 14; 15; 16; 17 mm (63mmL)	
	4pc	E10; E11; E12; E14	
	2pc	7; 8 mm (50mmL)	
	3pc	7; 8; 10 mm (50mmL)	
	3pc	T40; T45; T50 (50mmL)	
	5pc	M5; M6; M8; M9; M10 (50mmL)	
	1pc	QR thin pear ratchet handle 24teeth (80233)	
	2pc	3"(75mm); 6"(150mm)	
	1pc	3/8"	
	1pc	1/2"(F)x3/8"(M) for extension	

1/2"DR. Part			
	18pc	10; 11; 12; 13; 14; 15; 16; 17; 18; 19; 20; 21; 22; 23; 24; 27; 30; 32 mm	
	5pc	18; 19; 21; 22; 24 mm (77mmL)	
	5pc	E16; E18; E20; E22; E24	
	2pc	Spark plug 16; 20.6 mm	
	3pc	12 mm (55mmL); 14 mm (65mmL); 17 mm (70mmL)	
	2pc	T55; T60 (55mmL)	
	2pc	M12; M14 (55mmL)	
	1pc	QR thin pear ratchet handle 24teeth (80243)	
	2pc	5"(125mm); 10"(250mm)	
	1pc	1/2"	
	1pc	3/8"(F)x1/2"(M) for extension	

Bits			
	6pc	1/4" 2; 4; 6; 8; 10 mm (25mmL)	
	4pc	1/4" 1; 2; 3; 4 (25mmL)	
	6pc	1/4" 4; 6; 8; 10; 12; 14 mm (25mmL)	
	4pc	1/4" No.0; No.1; No.2; No.3 (25mmL)	
	6pc	1/4" 2; 2.5; 3; 4; 5; 6 mm (25mmL)	
	6pc	1/4" 5/64"; 3/32"; 7/64"; 1/8"; 9/64"; 5/32" (25mmL)	
	10pc	1/4" TS8; TS10; TS15; TS20; TS25; TS27; TS30; TS40; TS45; TS50 (21013)	

41801-27 2/23.0/24.0/2.2' 11.5kg

Changed items	
	1pc 1/4"DR. QR curved-shank ratchet handle 36teeth (802227)
	1pc 1/2"DR. QR curved-shank ratchet handle 36teeth (802327)
	1pc 1/2"DR. QR curved-shank ratchet handle 36teeth (802427)

23pc 1/2"DR. CabinBox Main set



4234A 4/16.5/17.5/0.9' 4125g

	18pc	10; 11; 12; 13; 14; 15; 16; 17; 18; 19; 20; 21; 22; 23; 24; 27; 30; 32 mm
	1pc	Round ratchet handle 72teeth (80249)
	2pc	5"(125mm); 10"(250mm)
	1pc	1/2"
	1pc	3/8"(F)x1/2"(M) for extension

65pc 1/4" & 1/2" CabinBox set



4234A+2421 4/20.1/21.1/0.9' 5025g

1/4"DR. Part (2421)			
	14pc	3.2; 4; 4.5; 5; 5.5; 6; 7; 8; 9; 10; 11; 12; 13; 14 mm	
	1pc	Round ratchet handle 72teeth (80229)	
	2pc	2"(50mm); 6"(150mm)	
	1pc	1/4"	
	1pc	3/8"(F)x1/4"(M) for extension	
	1pc	1/4"DR.x1/4"(F)	
	1pc	Magnetic socket pick-up (25mmL)	
	1pc	6"(150mm) with 1/4"DR.(F)	

Bits (2421)			
	3pc	1/4" PH.1; PH.2; PH.3 (25mmL)	
	3pc	1/4" PZ.1; PZ.2; PZ.3 (25mmL)	
	3pc	1/4" 4; 5.5; 6.5 mm (25mmL)	
	5pc	1/4" 3; 4; 5; 6; 8 mm (25mmL)	
	6pc	1/4" T10; T15; T20; T25; T30; T40 (25mmL)	

1/2"DR. Part (4234A)			
	18pc	10; 11; 12; 13; 14; 15; 16; 17; 18; 19; 20; 21; 22; 23; 24; 27; 30; 32 mm	
	1pc	Round ratchet handle 72teeth (80249)	
	2pc	5"(125mm); 10"(250mm)	
	1pc	1/2"	
	1pc	3/8"(F)x1/2"(M) for extension	

31pc 1/2"DR. CabinBox set

NEW



4234A+4091 4/20.3/21.3/0.9' 5064g

1/2"DR. Part (4234A)			
	18pc	10; 11; 12; 13; 14; 15; 16; 17; 18; 19; 20; 21; 22; 23; 24; 27; 30; 32 mm	
	1pc	Round ratchet handle 72teeth (80249)	
	2pc	5"(125mm); 10"(250mm)	
	1pc	1/2"	
	1pc	3/8"(F)x1/2"(M) for extension	

1/2"DR. Part (4091)			
	8pc	5; 6; 7; 8; 10; 12 mm (55mmL)	
		14mm (65mmL)	
		17mm (70mmL)	

23pc 1/2"DR. CabinBox Main set



4234B

3/13.5/14.5/1' 4500g

	18pc	10; 11; 12; 13; 14; 15; 16; 17; 18; 19; 20; 21; 22; 23; 24; 27; 30; 32 mm
	1pc	Round ratchet handle 72teeth (80249)
	2pc	5"(125mm); 10"(250mm)
	1pc	1/2"
	1pc	3/8"(F)x1/2"(M) for extension

88pc 1/4" & 1/2" CabinBox set



4234B+2641

3/19.0/20.0/1' 7000g

1/2"DR. Part (4234B)		
	18pc	10; 11; 12; 13; 14; 15; 16; 17; 18; 19; 20; 21; 22; 23; 24; 27; 30; 32 mm
	1pc	Round ratchet handle 72teeth (80249)
	2pc	5"(125mm); 10"(250mm)
	1pc	1/2"
	1pc	3/8"(F)x1/2"(M) for extension

1/4"DR. Part (2641)		
	14pc	3.2; 4; 4.5; 5; 5.5; 6; 7; 8; 9; 10; 11; 12; 13; 14 mm
	9pc	5; 6; 7; 8; 9; 10; 11; 12; 13 mm
	3pc	PH.1; PH.2; PH.3 (32mmL)
	3pc	PZ.1; PZ.2; PZ.3 (32mmL)
	3pc	4; 5.5; 6.5 mm (32mmL)
	7pc	3; 4; 5; 6; 7; 8; 10 mm (32mmL)
	8pc	T8; T10; T15; T20; T25; T27; T30; T40 (32mmL)
	1pc	Round ratchet handle 72teeth (80229)
	3pc	2"(50mm); 4"(100mm); 6"(150mm)
	1pc	4.5"(115mm)
	1pc	1/4"
	1pc	Magnetic socket pick-up (25mmL)
	1pc	6"(150mm) with 1/4"DR.(F)

Others (2641)		
	10pc	1.27; 1.5; 2; 2.5; 3; 4; 5; 6; 8; 10 mm (S102XLB)

97pc 1/4" & 1/2" CabinBox set

NEW



4234B+2742-8

3/16.5/17.5/1' 5490g

1/2"DR. Part (4234B)		
	18pc	10; 11; 12; 13; 14; 15; 16; 17; 18; 19; 20; 21; 22; 23; 24; 27; 30; 32 mm
	1pc	Round ratchet handle 72teeth (80249)
	2pc	5"(125mm); 10"(250mm)
	1pc	1/2"
	1pc	3/8"(F)x1/2"(M) for extension

1/4"DR. Part (2742-8)		
	12pc	4; 4.5; 5; 5.5; 6; 7; 8; 9; 10; 11; 12; 13 mm
	12pc	4; 4.5; 5; 5.5; 6; 7; 8; 9; 10; 11; 12; 13 mm (50mmL)
	6pc	E4; E5; E6; E7; E8; E10
	6pc	E4; E5; E6; E7; E8; E10 (50mmL)
	3pc	PH.0; PH.1; PH.2 (32mmL)
	3pc	PZ.0; PZ.1; PZ.2 (32mmL)
	3pc	4; 5.5; 6.5 mm (32mmL)
	7pc	3; 4; 5; 6; 7; 8; 10 mm (32mmL)
	8pc	T8; T10; T15; T20; T25; T27; T30; T40 (32mmL)
	8pc	T-8H; T-10H; T-15H; T-20H; T-25H; T-27H; T-30H; T-40H (32mmL)
	1pc	QR pear ratchet handle 72teeth (80228)
	3pc	2"(50mm); 4"(100mm); 6"(150mm)
	1pc	1/4"
	1pc	Magnetic socket pick-up (25mmL)

59pc 3/8" & 1/2" CabinBox set



4234B+3361

3/23.8/24.8/1' 7910g

1/2"DR. Part (4234B)		
	18pc	10; 11; 12; 13; 14; 15; 16; 17; 18; 19; 20; 21; 22; 23; 24; 27; 30; 32 mm
	1pc	Round ratchet handle 72teeth (80249)
	2pc	5"(125mm); 10"(250mm)
	1pc	1/2"
	1pc	3/8"(F)x1/2"(M) for extension

3/8"DR. Part (3361)		
	17pc	6; 7; 8; 9; 10; 11; 12; 13; 14; 15; 16; 17; 18; 19; 20; 21; 22 mm
	2pc	Spark plug 16; 20.6 mm
	1pc	Round ratchet handle 72teeth (80239)
	3pc	3"(75mm); 6"(150mm); 9"(225mm)
	1pc	3/8"
	1pc	1/2"(F)x3/8"(M) for extension

Others (3361)		
	11pc	7; 8; 9; 10; 11; 12; 13; 14; 15; 16; 17 mm

37pc 1/2"DR. CabinBox set

NEW



4234B+4143

3/21.0/22.0/1' 7010g

1/2"DR. Part (4234B)	
18pc	10; 11; 12; 13; 14; 15; 16; 17; 18; 19; 20; 21; 22; 23; 24; 27; 30; 32 mm
1pc	Round ratchet handle 72teeth (80249)
2pc	5"(125mm); 10"(250mm)
1pc	1/2"
1pc	3/8"(F)x1/2"(M) for extension
1/2"DR. Part (4143)	
14pc	10; 12; 13; 14; 15; 17; 19; 21; 22; 23; 24; 27; 30; 32 mm (77mmL)

81pc 1/2"DR. CabinBox set

NEW



4234B+4583

3/20.0/21.0/1' 6675g

1/2"DR. Part (4234B)	
18pc	10; 11; 12; 13; 14; 15; 16; 17; 18; 19; 20; 21; 22; 23; 24; 27; 30; 32 mm
1pc	Round ratchet handle 72teeth (80249)
2pc	5"(125mm); 10"(250mm)
1pc	1/2"
1pc	3/8"(F)x1/2"(M) for extension
1/2"DR. Part (4583)	
10pc	E8; E10; E11; E12; E14; E16; E18; E20; E22; E24
Bits (4583)	
7pc	10mm 4; 5; 6; 7; 8; 10; 12 mm (30mmL)
7pc	10mm 4; 5; 6; 7; 8; 10; 12 mm (75mmL)
9pc	10mm T20; T25; T27; T30; T40; T45; T50; T55; T60 (30mmL)
9pc	10mm T20; T25; T27; T30; T40; T45; T50; T55; T60 (75mmL)
7pc	10mm M5; M6; M7; M8; M9; M10; M12 (30mmL)
7pc	10mm M5; M6; M7; M8; M9; M10; M12 (75mmL)
2pc	3/8"DR.x10mm(F); 1/2"DR.x10mm(F)

39pc 1/2"DR. CabinBox set



4234B+5161

3/20.5/21.5/1' 6833g

1/2"DR. Part (4234B)	
18pc	10; 11; 12; 13; 14; 15; 16; 17; 18; 19; 20; 21; 22; 23; 24; 27; 30; 32 mm
1pc	Round ratchet handle 72teeth (80249)
2pc	5"(125mm); 10"(250mm)
1pc	1/2"
1pc	3/8"(F)x1/2"(M) for extension
Others (5161)	
16pc	6; 7; 8; 9; 10; 11; 12; 13; 14; 15; 16; 17; 18; 19; 22; 24 mm

24pc 1/2"DR. CabinBox Main set



4243B

3/15.5/16.5/1' 5230g

1/2"DR. Part (4243B)	
18pc	10; 11; 12; 13; 14; 15; 16; 17; 18; 19; 20; 21; 22; 23; 24; 27; 30; 32 mm
1pc	Round ratchet handle 72teeth (80249)
1pc	15"(380mm)
2pc	5"(125mm); 10"(250mm)
1pc	1/2"
1pc	3/8"(F)x1/2"(M) for extension

52pc 1/2"DR. CabinBox set

NEW



4243B+4283

3/17.9/18.9/1' 5973g

1/2"DR. Part (4243B)	
18pc	10; 11; 12; 13; 14; 15; 16; 17; 18; 19; 20; 21; 22; 23; 24; 27; 30; 32 mm
1pc	Round ratchet handle 72teeth (80249)
1pc	15"(380mm)
2pc	5"(125mm); 10"(250mm)
1pc	1/2"
1pc	3/8"(F)x1/2"(M) for extension
Bits (4283)	
7pc	10mm 4; 5; 6; 7; 8; 10; 12 mm (30mmL)
4pc	10mm 5; 6; 8; 10 mm (75mmL)
7pc	10mm T20; T25; T30; T40; T45; T50; T55 (30mmL)
4pc	10mm M5; M6; M8; M10 (30mmL)
4pc	10mm M6; M8; M10; M12 (75mmL)
2pc	3/8"DR.x10mm(F); 1/2"DR.x10mm(F)

17pc 1/2"DR. Socket combination set (SAE)



4173S 6/16.0/17.0/0.7' 2660g

	13pc	5/16"; 3/8"; 7/16"; 15/32"; 1/2"; 9/16"; 19/32"; 5/8"; 11/16"; 3/4"; 13/16"; 7/8"; 1"
	1pc	Spark plug 20.6mm (13/16")
	1pc	QR thin pear ratchet handle 24teeth (80243)
	1pc	5"(125mm)
	1pc	10"(250mm)

4173S-5 6/16.0/17.0/0.7' 2660g

Changed items

	13pc	5/16"; 3/8"; 7/16"; 15/32"; 1/2"; 9/16"; 19/32"; 5/8"; 11/16"; 3/4"; 13/16"; 7/8"; 1"
--	------	---

4173S-9 6/16.0/17.0/0.7' 2660g

Changed items

	13pc	5/16"; 3/8"; 7/16"; 15/32"; 1/2"; 9/16"; 19/32"; 5/8"; 11/16"; 3/4"; 13/16"; 7/8"; 1"
--	------	---

24pc 1/2"DR. Socket combination set (SAE)



4243S 4/22.0/23.0/0.9' 5500g

	18pc	5/16"; 3/8"; 7/16"; 1/2"; 9/16"; 19/32"; 5/8"; 11/16"; 3/4"; 25/32"; 13/16"; 7/8"; 15/16"; 1"; 1-1/16"; 1-1/8"; 1-3/16"; 1-1/4"
	1pc	QR thin pear ratchet handle 24teeth (80243)
	1pc	15"(380mm)
	2pc	5"(125mm); 10"(250mm)
	1pc	10"(250mm)
	1pc	1/2"

4243S-5 4/22.0/23.0/0.9' 5500g

Changed items

	18pc	5/16"; 3/8"; 7/16"; 1/2"; 9/16"; 19/32"; 5/8"; 11/16"; 3/4"; 25/32"; 13/16"; 7/8"; 15/16"; 1"; 1-1/16"; 1-1/8"; 1-3/16"; 1-1/4"
--	------	---

4243S-9 4/22.0/23.0/0.9' 5500g

Changed items

	18pc	5/16"; 3/8"; 7/16"; 1/2"; 9/16"; 19/32"; 5/8"; 11/16"; 3/4"; 25/32"; 13/16"; 7/8"; 15/16"; 1"; 1-1/16"; 1-1/8"; 1-3/16"; 1-1/4"
--	------	---

24pc 1/2"DR. Socket combination set (SAE)



4245S 4/20.7/21.7/0.9' 5175g

	18pc	5/16"; 3/8"; 7/16"; 1/2"; 9/16"; 19/32"; 5/8"; 11/16"; 3/4"; 25/32"; 13/16"; 7/8"; 15/16"; 1"; 1-1/16"; 1-1/8"; 1-3/16"; 1-1/4"
	1pc	QR thin pear ratchet handle 24teeth (80244)
	2pc	5"(125mm); 10"(250mm)
	1pc	10"(250mm)
	1pc	1/2"
	1pc	16.3"(415mm)

4245S-7 4/20.7/21.7/0.9' 5175g

Changed items

	18pc	5/16"; 3/8"; 7/16"; 1/2"; 9/16"; 19/32"; 5/8"; 11/16"; 3/4"; 25/32"; 13/16"; 7/8"; 15/16"; 1"; 1-1/16"; 1-1/8"; 1-3/16"; 1-1/4"
--	------	---

4245S-9 4/20.7/21.7/0.9' 5175g

Changed items

	18pc	5/16"; 3/8"; 7/16"; 1/2"; 9/16"; 19/32"; 5/8"; 11/16"; 3/4"; 25/32"; 13/16"; 7/8"; 15/16"; 1"; 1-1/16"; 1-1/8"; 1-3/16"; 1-1/4"
--	------	---

24pc 1/2"DR. Socket combination set (SAE)



4245BS 4/20.7/21.7/0.9' 5175g

	18pc	5/16"; 3/8"; 7/16"; 1/2"; 9/16"; 19/32"; 5/8"; 11/16"; 3/4"; 25/32"; 13/16"; 7/8"; 15/16"; 1"; 1-1/16"; 1-1/8"; 1-3/16"; 1-1/4"
	1pc	QR thin pear ratchet handle 24teeth (80244)
	1pc	15"(380mm)
	2pc	5"(125mm); 10"(250mm)
	1pc	10"(250mm)
	1pc	1/2"



4245BS-7 4/20.7/21.7/0.9' 5175g







Changed items



	18pc	5/16"; 3/8"; 7/16"; 1/2"; 9/16"; 19/32"; 5/8"; 11/16"; 3/4"; 25/32"; 13/16"; 7/8"; 15/16"; 1"; 1-1/16"; 1-1/8"; 1-3/16"; 1-1/4"
--	------	---

24pc 1/2"DR. Socket combination set (SAE)



4246S  4/20.6/21.6/0.9'  5150g

	18pc	5/16"; 3/8"; 7/16"; 1/2"; 9/16"; 19/32"; 5/8"; 11/16"; 3/4"; 25/32"; 13/16"; 7/8"; 15/16"; 1"; 1-1/16"; 1-1/8"; 1-3/16"; 1-1/4"
	1pc	Spark plug 20.6mm (13/16")
	1pc	QR thin pear ratchet handle 24teeth (80243)
	2pc	5"(125mm); 10"(250mm)
	1pc	10"(250mm)
	1pc	1/2"



4246S-5  4/20.6/21.6/0.9'  5150g







Changed items

	18pc	5/16"; 3/8"; 7/16"; 1/2"; 9/16"; 19/32"; 5/8"; 11/16"; 3/4"; 25/32"; 13/16"; 7/8"; 15/16"; 1"; 1-1/16"; 1-1/8"; 1-3/16"; 1-1/4"
---	------	---

32pc 1/2"DR. 6pt. Flank socket & combination wrench set (SAE)











4325  4/19.6/20.6/1.2'  5175g



	15pc	5/16"; 3/8"; 7/16"; 1/2"; 9/16"; 19/32"; 5/8"; 11/16"; 3/4"; 25/32"; 13/16"; 15/16"; 1-1/16"; 1-1/8"; 1-1/4"
	2pc	Spark plug 16mm (5/8"); 20.6mm (13/16")
	1pc	QR thin pear ratchet handle 24teeth (80243)
	2pc	5"(125mm); 10"(250mm)
	1pc	10"(250mm)
	1pc	1/2"
	10pc	1/4"; 5/16"; 3/8"; 7/16"; 1/2"; 9/16"; 5/8"; 11/16"; 3/4"; 13/16"

24pc 1/2"DR. Socket combination set (SAE)



4246SB-5  4/16.0/17.0/0.87'  4000g

	18pc	1/4"; 5/16"; 3/8"; 7/16"; 1/2"; 9/16"; 5/8"; 11/16"; 3/4"; 25/32"; 13/16"; 7/8"; 15/16"; 1"; 1-1/16"; 1-1/8"; 1-3/16"; 1-1/4"
	1pc	Spark plug 20.6mm (13/16")
	1pc	QR thin pear ratchet handle 24teeth (80243)
	2pc	5"(125mm); 10"(250mm)
	1pc	10"(250mm)
	1pc	1/2"



4246SB-9  4/16.0/17.0/0.87'  4000g









Changed items

	18pc	1/4"; 5/16"; 3/8"; 7/16"; 1/2"; 9/16"; 5/8"; 11/16"; 3/4"; 25/32"; 13/16"; 7/8"; 15/16"; 1"; 1-1/16"; 1-1/8"; 1-3/16"; 1-1/4"
---	------	---

31pc 1/2"DR. 6pt. Flank socket & combination wrench set (S&M)



4312  4/15.2/16.2/0.85'  3800g

	9pc	10; 12; 13; 14; 15; 16; 17; 18; 19 mm
	7pc	3/8"; 7/16"; 1/2"; 9/16"; 5/8"; 11/16"; 3/4"
	2pc	Spark plug 16mm (5/8"); 20.6mm (13/16")
	1pc	QR thin pear ratchet handle 24teeth (80244)
	2pc	5"(125mm); 10"(250mm)
	1pc	1/2"
	1pc	3/8"(F)x1/2"(M) for extension
	8pc	8; 10; 11; 12; 13; 14; 17; 19 mm

32pc 1/2"DR. Socket combination set (S&M)



4321 4/22.2/23.2/0.9' 5550g

	20pc	8; 9; 10; 11; 12; 13; 14; 15; 16; 17; 18; 19; 20; 21; 22; 23; 24; 26; 27; 32 mm
	4pc	3/8"; 1/2"; 9/16"; 11/16"
	2pc	Spark plug 16mm (5/8"); 20.6mm (13/16")
	1pc	QR pear ratchet handle 24teeth (802411)
	1pc	15"(380mm)
	3pc	3"(75mm); 5"(125mm); 10"(250mm)
	1pc	1/2"

4321-7 4/22.2/23.2/0.9' 5550g

Changed items

	20pc	8; 9; 10; 11; 12; 13; 14; 15; 16; 17; 18; 19; 20; 21; 22; 23; 24; 26; 27; 32 mm
	4pc	3/8"; 1/2"; 9/16"; 11/16"

41pc 1/2"DR. Socket combination set (S&M)



4412 4/26.6/27.6/0.9' 6650g

	18pc	10; 11; 12; 13; 14; 15; 16; 17; 18; 19; 20; 21; 22; 23; 24; 27; 30; 32 mm
	15pc	3/8"; 7/16"; 1/2"; 9/16"; 5/8"; 11/16"; 3/4"; 13/16"; 7/8"; 15/16"; 1"; 1-1/16"; 1-1/8"; 1-3/16"; 1-1/4"
	2pc	Spark plug 16mm (5/8"); 20.6mm (13/16")
	1pc	QR pear ratchet handle 24teeth (80242)
	2pc	5"(125mm); 10"(250mm)
	1pc	10"(250mm)
	1pc	1/2"
	1pc	16.3"(415mm)

4412-5 4/26.6/27.6/0.9' 6650g

Changed items

	18pc	10; 11; 12; 13; 14; 15; 16; 17; 18; 19; 20; 21; 22; 23; 24; 27; 30; 32 mm
	15pc	3/8"; 7/16"; 1/2"; 9/16"; 5/8"; 11/16"; 3/4"; 13/16"; 7/8"; 15/16"; 1"; 1-1/16"; 1-1/8"; 1-3/16"; 1-1/4"

41pc 1/2"DR. 6pt. Flank socket combination set (S&M)



4415 3/23.5/24.5/0.9' 7820g

	18pc	10; 11; 12; 13; 14; 15; 16; 17; 18; 19; 20; 21; 22; 23; 24; 27; 30; 32 mm
	15pc	3/8"; 7/16"; 1/2"; 9/16"; 5/8"; 11/16"; 3/4"; 13/16"; 7/8"; 15/16"; 1"; 1-1/16"; 1-1/8"; 1-3/16"; 1-1/4"
	2pc	Spark plug 16mm (5/8"); 20.6mm (13/16")
	1pc	QR pear ratchet handle 72teeth (80248)
	1pc	15"(380mm)
	2pc	5"(125mm); 10"(250mm)
	1pc	10"(250mm)
	1pc	1/2"

64pc 3/8" & 1/2" Socket combination set (S&M)



4641 2/22.0/23.0/0.77' 11kg

3/8"DR. Part

	7pc	13; 14; 15; 16; 17; 18; 19 mm
	4pc	3/8"; 1/2"; 9/16"; 11/16"
	11pc	8; 10; 11; 12; 13; 14; 15; 16; 17; 18; 19 mm (63mmL)
	4pc	3/8"; 1/2"; 9/16"; 11/16" (63mmL)
	3pc	Spark plug 16mm (5/8"); 18mm; 20.6mm (13/16")
	1pc	QR pear ratchet handle 24teeth (802311)
	2pc	3"(75mm); 10"(250mm)
	1pc	6.5"(165mm)
	1pc	3/8"
	1pc	1/2"(F)x3/8"(M) for extension

1/2"DR. Part

	11pc	20; 21; 22; 23; 24; 25; 26; 27; 28; 30; 32 mm
	3pc	13/16"; 1"; 1-1/8" (77mmL)
	9pc	12pt. WW 3/16"; 1/4"; 5/16"; 3/8"; 7/16"; 1/2"; 9/16"; 5/8"; 3/4"
	1pc	QR pear ratchet handle 24teeth (802411)
	1pc	15"(380mm)
	2pc	5"(125mm); 10"(250mm)
	1pc	1/2"
	1pc	16.3"(415mm)

65pc 1/4" & 1/2" & 3/4" Socket combination set (S&M)



4652 2/28.5/29.5/0.77' 14.2kg

1/4"DR. Part

	9pc	4; 5.5; 6; 7; 8; 9; 10; 11; 12 mm
	3pc	3/16"; 1/4"; 3/8"
	1pc	QR pear ratchet handle 24teeth (80222)
	1pc	5.5"(140mm)
	2pc	2"(50mm); 6"(150mm)
	1pc	4.5"(115mm)
	1pc	1/4"
	1pc	6"(150mm) with 1/4"DR.(F)
	1pc	Cross bar 115mm (8032115A)

1/2"DR. Part

	21pc	8; 9; 10; 11; 12; 13; 14; 15; 16; 17; 19; 20; 21; 22; 23; 24; 26; 27; 29; 30; 32 mm
	5pc	3/8"; 1/2"; 9/16"; 11/16"; 1"
	1pc	QR pear ratchet handle 24teeth (80242)
	1pc	15"(380mm)
	3pc	3"(75mm); 5"(125mm); 10"(250mm)
	1pc	10"(250mm)
	1pc	1/2"
	1pc	Cross bar 150mm (8034150A)

3/4"DR. Part

	9pc	26; 27; 29; 30; 32; 35; 36; 38; 41 mm
	1pc	QR pear ratchet handle 24teeth (8026500)
	1pc	8"(200mm)

163pc 1/2"DR. Socket set



41631S 1/24.3/25.3/2.35' 24.3kg

	1pc	Short socket storage L58 x W11 x H45 cm (50141S)
	65pc	Each 13pcs - 10; 11; 12; 13; 14 mm
	24pc	Each 12pcs - 16; 17 mm
	20pc	Each 10pcs - 19; 21 mm
	18pc	Each 9pcs - 22; 23 mm
	16pc	Each 8pcs - 24; 26 mm
	14pc	Each 7pcs - 27; 30 mm
	6pc	Each 6pcs - 32 mm

41631S-7 1/24.3/25.3/2.35' 24.3kg

	1pc	Short socket storage L58 x W11 x H45 cm (50141S)
	65pc	Each 13pcs - 10; 11; 12; 13; 14 mm
	24pc	Each 12pcs - 16; 17 mm
	20pc	Each 10pcs - 19; 21 mm
	18pc	Each 9pcs - 22; 23 mm
	16pc	Each 8pcs - 24; 26 mm
	14pc	Each 7pcs - 27; 30 mm
	6pc	Each 6pcs - 32 mm

41631S-9 1/24.3/25.3/2.35' 24.3kg

	1pc	Short socket storage L58 x W11 x H45 cm (50141S)
	65pc	Each 13pcs - 10; 11; 12; 13; 14 mm
	24pc	Each 12pcs - 16; 17 mm
	20pc	Each 10pcs - 19; 21 mm
	18pc	Each 9pcs - 22; 23 mm
	16pc	Each 8pcs - 24; 26 mm
	14pc	Each 7pcs - 27; 30 mm
	6pc	Each 6pcs - 32 mm

163pc 1/2"DR. Deep socket set



41631D 1/45.8/46.8/1.55' 45.8kg

	1pc	Deep socket storage L58 x W11 x H45 cm (50141D)
	65pc	Each 13pcs - 10; 11; 12; 13; 14 mm (77mmL)
	24pc	Each 12pcs - 16; 17 mm (77mmL)
	20pc	Each 10pcs - 19; 21 mm (77mmL)
	18pc	Each 9pcs - 22; 23 mm (77mmL)
	16pc	Each 8pcs - 24; 26 mm (77mmL)
	14pc	Each 7pcs - 27; 30 mm (77mmL)
	6pc	Each 6pcs - 32 mm (77mmL)

41631D-7 1/45.8/46.8/1.55' 45.8kg

	1pc	Deep socket storage L58 x W11 x H45 cm (50141D)
	65pc	Each 13pcs - 10; 11; 12; 13; 14 mm (77mmL)
	24pc	Each 12pcs - 16; 17 mm (77mmL)
	20pc	Each 10pcs - 19; 21 mm (77mmL)
	18pc	Each 9pcs - 22; 23 mm (77mmL)
	16pc	Each 8pcs - 24; 26 mm (77mmL)
	14pc	Each 7pcs - 27; 30 mm (77mmL)
	6pc	Each 6pcs - 32 mm (77mmL)

41631D-9 1/45.8/46.8/1.55' 45.8kg

	1pc	Deep socket storage L58 x W11 x H45 cm (50141D)
	65pc	Each 13pcs - 10; 11; 12; 13; 14 mm (77mmL)
	24pc	Each 12pcs - 16; 17 mm (77mmL)
	20pc	Each 10pcs - 19; 21 mm (77mmL)
	18pc	Each 9pcs - 22; 23 mm (77mmL)
	16pc	Each 8pcs - 24; 26 mm (77mmL)
	14pc	Each 7pcs - 27; 30 mm (77mmL)
	6pc	Each 6pcs - 32 mm (77mmL)

153pc 1/2"DR. Socket set (SAE)

NEW

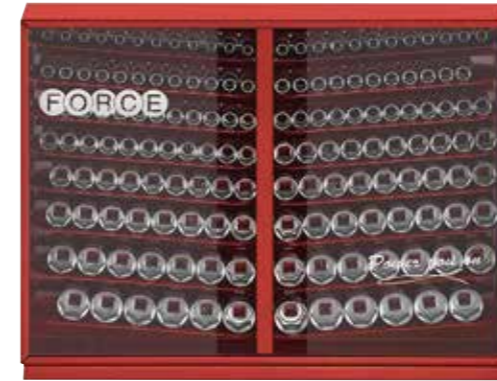

41531S 1/24.3/25.3/2.35' 24.3kg

	1pc	Short socket storage L58 x W11 x H45 cm (50141SS)
	72pc	Each 12pcs - 5/16"; 3/8"; 7/16"; 1/2"; 9/16"; 5/8"
	11pc	Each 11pcs - 11/16"
	10pc	Each 10pcs - 3/4"
	18pc	Each 9pcs - 13/16"; 7/8"
	16pc	Each 8pcs - 15/16"; 1"
	14pc	Each 7pcs - 1-1/16"; 1-1/8"
	12pc	Each 6pcs - 1-3/16"; 1-1/4"

41531S-9 1/24.3/25.3/2.35' 24.3kg

	1pc	Short socket storage L58 x W11 x H45 cm (50141SS)
	72pc	Each 12pcs - 5/16"; 3/8"; 7/16"; 1/2"; 9/16"; 5/8"
	11pc	Each 11pcs - 11/16"
	10pc	Each 10pcs - 3/4"
	18pc	Each 9pcs - 13/16"; 7/8"
	16pc	Each 8pcs - 15/16"; 1"
	14pc	Each 7pcs - 1-1/16"; 1-1/8"
	12pc	Each 6pcs - 1-3/16"; 1-1/4"

41531S-7 1/24.3/25.3/2.35' 24.3kg

	1pc	Short socket storage L58 x W11 x H45 cm (50141SS)
	72pc	Each 12pcs - 5/16"; 3/8"; 7/16"; 1/2"; 9/16"; 5/8"
	11pc	Each 11pcs - 11/16"
	10pc	Each 10pcs - 3/4"
	18pc	Each 9pcs - 13/16"; 7/8"
	16pc	Each 8pcs - 15/16"; 1"
	14pc	Each 7pcs - 1-1/16"; 1-1/8"
	12pc	Each 6pcs - 1-3/16"; 1-1/4"

153pc 1/2"DR. Deep socket set (SAE)

NEW



41531D 1/45.8/46.8/1.55' 45.8kg

	1pc	Deep socket storage L58 x W11 x H45 cm (50141DS)
	72pc	Each 12pcs - 5/16"; 3/8"; 7/16"; 1/2"; 9/16"; 5/8" (77mmL)
	11pc	Each 11pcs - 11/16" (77mmL)
	10pc	Each 10pcs - 3/4" (77mmL)
	18pc	Each 9pcs - 13/16"; 7/8" (77mmL)
	16pc	Each 8pcs - 15/16"; 1" (77mmL)
	14pc	Each 7pcs - 1-1/16"; 1-1/8" (77mmL)
	12pc	Each 6pcs - 1-3/16"; 1-1/4" (77mmL)

41531D-9 1/45.8/46.8/1.55' 45.8kg

	1pc	Deep socket storage L58 x W11 x H45 cm (50141DS)
	72pc	Each 12pcs - 5/16"; 3/8"; 7/16"; 1/2"; 9/16"; 5/8" (77mmL)
	11pc	Each 11pcs - 11/16" (77mmL)
	10pc	Each 10pcs - 3/4" (77mmL)
	18pc	Each 9pcs - 13/16"; 7/8" (77mmL)
	16pc	Each 8pcs - 15/16"; 1" (77mmL)
	14pc	Each 7pcs - 1-1/16"; 1-1/8" (77mmL)
	12pc	Each 6pcs - 1-3/16"; 1-1/4" (77mmL)

41531D-7 1/45.8/46.8/1.55' 45.8kg

	1pc	Deep socket storage L58 x W11 x H45 cm (50141DS)
	72pc	Each 12pcs - 5/16"; 3/8"; 7/16"; 1/2"; 9/16"; 5/8" (77mmL)
	11pc	Each 11pcs - 11/16" (77mmL)
	10pc	Each 10pcs - 3/4" (77mmL)
	18pc	Each 9pcs - 13/16"; 7/8" (77mmL)
	16pc	Each 8pcs - 15/16"; 1" (77mmL)
	14pc	Each 7pcs - 1-1/16"; 1-1/8" (77mmL)
	12pc	Each 6pcs - 1-3/16"; 1-1/4" (77mmL)

3-Layer socket display shelf



50121		1/12.4/13.4/2'		12.4kg
	20pc	Short partition		
	20pc	Medium partition		
	15pc	Long partition		

3-Layer socket display shelf with 429pc sockets



50121A-429		1/34.6/36.7/2.8'		34.6kg
	1pc	Socket display shelf with size sticker L42 x W35 x H48 cm (50121A)		
	130pc	Each 10pcs - 4; 4.5; 5; 5.5; 6; 7; 8; 9; 10; 11; 12; 13; 14 mm		
	68pc	Each 10pcs - 8; 10; 12; 13; 14 mm Each 9pcs - 17; 19 mm		
	231pc	Each 20pcs - 21 mm Each 10pcs - 8; 9; 10; 11; 12; 13; 14; 15; 16; 17; 18; 19; 20; 22; 23; 24 mm Each 9pcs - 25; 26; 27 mm Each 8pcs - 28; 30; 32 mm		

3-Layer socket display shelf with 452pc sockets

NEW



50121D-452		1/42.73/44.83/2.57'		42.7kg
	1pc	Socket display shelf with size sticker L42 x W35 x H48 cm (50121D)		
	70pc	Each 10pcs - E4; E5; E6; E7; E8; E10; E11		
	90pc	Each 10pcs - 6; 7; 8; 9; 10; 11; 12; 13; 14 mm (50mmL)		
	100pc	Each 10pcs - E8; E10; E11; E12; E14; E16; E18; E20; E22; E24		
	192pc	Each 10pcs - 8; 9; 10; 11; 12; 13; 14; 15; 16; 17; 18; 19; 20; 21; 22; 24 mm (77mmL) Each 9pcs - 27 mm (77mmL) Each 8pcs - 28; 30 mm (77mmL) Each 7pcs - 32 mm (77mmL)		

3-Layer socket display shelf with 460pc socket bits



50121B-460		1/53.4/55.5/3.1'		53.4kg
	1pc	Socket display shelf with size sticker L42 x W35 x H48 cm (50121B)		
	60pc	Each 10pcs - 3; 4; 5; 6; 7; 8 mm (32mmL)		
	80pc	Each 10pcs - T8; T10; T15; T20; T25; T27; T30; T40 (32mmL)		
	70pc	Each 10pcs - 7; 8; 10; 12 mm (55mmL) 14 mm (65mmL) 17; 19 mm (70mmL)		
	39pc	Each 10pcs - 6; 8; 10 mm (100mmL) Each 9pcs - 12 mm (100mmL)		
	60pc	Each 10pcs - T45; T50; T55; T60; T70 (55mmL) T80 (70mmL)		
	28pc	Each 10pcs - T40 (100mmL) Each 9pcs - T60; T70 (100mmL)		
	50pc	Each 10pcs - M8; M9; M10 (100mmL)		
	55pc	Each 10pcs - M6; M8; M10; M12; M14 (55mmL) Each 9pcs - M12; M14 (100mmL) Each 7pcs - M18 (100mmL)		
	10pc	Each 10pcs - M16 (55mmL)		
	8pc	Each 8pcs - M16 (100mmL)		

3-Layer socket display shelf with 408pc sockets (SAE)



50121C-408		1/42.7/44.8/2.9'		42.7kg
	1pc	Socket display shelf with size sticker L42 x W35 x H48 cm (50121C)		
	130pc	Each 10pcs - 5/32"; 3/16"; 7/32"; 1/4"; 9/32"; 5/16"; 11/32"; 3/8"; 13/32"; 7/16"; 15/32"; 1/2"; 9/16"		
	192pc	Each 10pcs - 1/4"; 5/16"; 3/8"; 7/16"; 15/32"; 1/2"; 9/16"; 19/32"; 5/8"; 11/16"; 3/4"; 25/32"; 13/16"; 7/8"; 15/16" Each 9pcs - 1"; 1-1/16" Each 8pcs - 1-1/8"; 1-3/16"; 1-1/4"		
	86pc	Each 10pcs - 3/8"; 1/2"; 9/16"; 5/8" (77mmL) Each 9pcs - 11/16" (77mmL) Each 8pcs - 3/4"; 13/16" (77mmL) Each 7pcs - 7/8"; 15/16"; 1" (77mmL)		

1/2"DR. Phillips socket bit



341		<i>l</i>		
Part no.	size	mm	g	pc/box
341552	PH.2	55	63	10
341553	PH.3	55	65	10
341554	PH.4	55	70	10

1/2"DR. Pozidriv socket bit



342		<i>l</i>		
Part no.	size	mm	g	pc/box
342552	PZ.2	55	65	10
342553	PZ.3	55	65	10
342554	PZ.4	55	70	10

1/2"DR. Slotted socket bit (one-piece)



343		<i>l</i>		
Part no.	size	mm	g	pc/box
34313	13	38	77	10
34319	19	38	84	10
34324	24	38	86	10

1/2"DR. Slotted socket bit



343		<i>l</i>		
Part no.	size	mm	g	pc/box
3435508	1.2 x 8	55	70	10
3435509	1.6 x 9	55	70	10
3435510	1.6 x 10	55	70	10
3435511	1.8 x 11	55	92	10
3435512	2.0 x 12	55	102	10
3435514	2.5 x 14	55	112	10
3435516	2.5 x 16	55	112	10

1/2"DR. Hex socket bit (one-piece)



344		<i>l</i>		
Part no.	size	mm	g	pc/box
34404	4	38	56	10
34405	5	38	56	10
34406	6	38	58	10
34407	7	38	59	10
34408	8	38	71	10
34410	10	40	76	10
34412	12	40	83	10
34414	14	40	91	10
34417	17	42	103	10
34419	19	42	112	10

1/2"DR. Hex socket bit

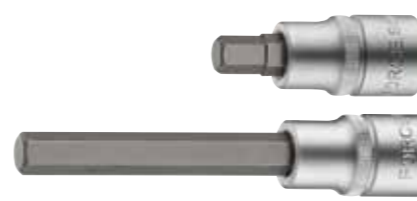

344		<i>l</i>		
Part no.	size	mm	g	pc/box
34405504	4	55	62	10
34405505	5	55	64	10
34405506	6	55	65	10
34405507	7	55	68	10
34405508	8	55	69	10
34405509	9	55	79	10
34405510	10	55	80	10
34405512	12	55	103	10
34406514	14	65	149	10
34407017	17	70	196	10
34407019	19	70	235	10
3440555.32	5/32"	55	63	10
3440553.16	3/16"	55	63	10
3440557.32	7/32"	55	63	10
3440551.4	1/4"	55	63	10
3440555.16	5/16"	55	69	10
3440553.8	3/8"	55	79	10
3440557.16	7/16"	55	102	10
3440551.2	1/2"	55	112	10
3440659.16	9/16"	65	150	10
3440655.8	5/8"	65	154	10
3440703.4	3/4"	70	242	10
34407006	6	70	70	10
34408006	6	80	75	10
34408008	8	80	80	10
34410004	4	100	69	10
34410005	5	100	78	10
34410006	6	100	78	10
34410007	7	100	87	10
34410008	8	100	88	10
34410009	9	100	104	10
34410010	10	100	108	10
34410011	11	100	144	10
34410012	12	100	145	10
34410013	13	100	148	10
34410014	14	100	197	10

344		<i>l</i>		
Part no.	size	mm	g	pc/box
34411005	5	110	85	10
34411006	6	110	85	10
34411007	7	110	91	10
34411008	8	110	93	10
34411010	10	110	117	10
34411012	12	110	162	10
34411014	14	110	207	10
34411017	17	110	274	10
34411019	19	110	331	10
34412008	8	120	100	10
34413008	8	130	105	10
34414006	6	140	89	10
34414008	8	140	104	10
34414010	10	140	139	10
34414012	12	140	186	10
34414014	14	140	245	10
34415007	7	150	103	10
34416006	6	160	95	10
34418005	5	180	120	10
34419008	8	190	130	10
34422006	6	220	115	10
34424806	6	248	125	10

• 34410011: for VW-Audi, Seat, Skoda petrol engines. to remove and replace the plastic insert for injector valves.

• 34410013: for VW-Audi, Seat, Skoda 4 Cylinder TDI PD engines. To loosen and fasten of the central retaining bolt of Fuel Cooling Unit, example to replace the Fuel filter.

1/2"DR. Hex ball point socket bit



Part no.	size	mm	g	pc/box
34510005	5	100	76	10
34510006	6	100	80	10
34510008	8	100	88	10
34510010	10	100	108	10
34524005	5	240	125	10
34524008	8	240	130	10

1/2"DR. Star socket bit



Part no.	size	mm	g	pc/box
34605520	T20	55	62	10
34605525	T25	55	63	10
34605527	T27	55	63	10
34605530	T30	55	63	10
34605535	T35	55	63	10
34605540	T40	55	64	10
34605545	T45	55	67	10
34605547	T47	55	67	10
34605550	T50	55	68	10
34605555	T55	55	79	10
34605560	T60	55	101	10
34605570	T70	55	132	10
34607080	T80	70	185	10
34610020	T20	100	74	10
34610025	T25	100	74	10
34610027	T27	100	75	10
34610030	T30	100	76	10
34610035 NEW	T35	100	76	10
34610040	T40	100	76	10
34610045	T45	100	86	10
34610047 NEW	T47	100	86	10

Part no.	size	mm	g	pc/box
34610050	T50	100	87	10
34610055	T55	100	108	10
34610060	T60	100	146	10
34610070	T70	100	191	10
34610080	T80	100	246	10
34610090	T90	100	299	5
346100100	T100	100	350	5
34611050R	T50	110	121	10
34612040	T40	120	90	10
34612045	T45	120	100	10
34612070	T70	120	211	10
34614045	T45	140	103	10
34614050	T50	140	104	10
34614055	T55	140	138	10
34614060	T60	140	184	10
34614070	T70	140	198	10
34614080 NEW	T80	140	319	5
34614090	T90	140	383	5
346140100	T100	140	435	5
34620030	T30	200	110	10
34620040	T40	200	110	10
34620045	T45	200	135	10
34620050	T50	200	138	10

• 34611050R bit is made by 10mm round steel, be applied in alternator of vehicle.(see no.678)

1/2"DR. Star socket bit (one-piece)



Part no.	size	mm	g	pc/box
34620	T20	37	63	10
34625	T25	37	63	10
34627	T27	37	68	10
34630	T30	37	68	10
34640	T40	37	68	10
34645	T45	37	70	10
34647	T47	37	71	10
34650	T50	40	72	10
34655	T55	40	75	10
34660	T60	40	77	10

1/2"DR. Star tamperproof socket bit



Part no.	size	mm	g	pc/box
34705520	T-20H	55	62	10
34705525	T-25H	55	62	10
34705527	T-27H	55	62	10
34705530	T-30H	55	62	10
34705540	T-40H	55	64	10
34705545	T-45H	55	68	10
34705550	T-50H	55	68	10
34705555	T-55H	55	78	10
34705560	T-60H	55	104	10
34705570	T-70H	55	131	10
34707080	T-80H	70	139	10
34710020	T-20H	100	76	10
34710025	T-25H	100	76	10
34710027	T-27H	100	76	10
34710030	T-30H	100	76	10
34710040	T-40H	100	76	10
34710045	T-45H	100	85	10
34710050	T-50H	100	87	10
34710055	T-55H	100	108	10
34710060	T-60H	100	143	10
34710070	T-70H	100	189	10
34710080	T-80H	100	238	10
34710090	T-90H	100	296	5
347100100	T-100H	100	346	5
34710570	T-70H	105	168	10
34712070	T-70H	120	212	10
34713030	T-30H	130	85	10
34714055	T-55H	140	137	10
34714080 NEW	T-80H	140	312	5
34714090	T-90H	140	380	5
347140100	T-100H	140	434	5

• 34707080 : For removal and replacement of the wind screen wiper arm and adjusting the pressure on BMW E31, E38 and E39.

• 34713030 To remove and replace the screws on airbag of BMW, Mercedes, VW, Audi.

1/2"DR. Spline socket bit



Part no.	size	mm	g	pc/box
34805505	M5	55	67	10
34805506	M6	55	67	10
34805507 NEW	M7	55	67	10
34805508	M8	55	67	10
34805509	M9	55	77	10
34805510	M10	55	78	10
34805512	M12	55	100	10
34805514	M14	55	131	10
34805516	M16	55	162	10
34807017 NEW	M17	70	109	10
34807018 NEW	M18	70	233	10
34810005	M5	100	80	10
34810006	M6	100	85	10
34810007 NEW	M7	100	86	10
34810008	M8	100	87	10
34810009	M9	100	95	10
348100095	M9.5	100	102	10
34810010	M10	100	108	10
34810012	M12	100	151	10
34810014	M14	100	187	10
34810016	M16	100	242	10
34810018	M18	100	305	10
34811010	M10	110	113	10
34811012	M12	110	160	10
34811014	M14	110	205	10
34811016	M16	110	234	10
34811010R	M10	110	121	10
34812008	M8	120	95	10
34812009	M9	120	121	10
34812010	M10	120	121	10
34812012 NEW	M12	120	121	10
34814008	M8	140	110	10
34814009	M9	140	140	10
34814010	M10	140	140	10
34814012	M12	140	152	10
34814014	M14	140	256	10
34880008	M8	800	610	10
34880010	M10	800	616	10

• 34880008, 34880010 The special length - 800mm provides access to Axle Shafts for removal & replacement on AUDI/VW vehicles

• 34811010R bit is made by 10mm round steel, to be applied in alternator of vehicle.(see no.674)

1/2"DR. Spline security socket bit



Part no.	size	mm	g	pc/box
34805514T	M14	55	130	10
34805516T	M16	55	142	10
34810016T	M16	100	270	10

• For removal and replacement of the gear box drain plug Audi A3,A4,A6;VW Golf IV,LT.

1/2"DR. Ribe socket bit



Part no.	size	mm	g	pc/box
34905506	M6	55	70	10
34906306	M6	63	68	10
34910005	M5	100	82	10
34910006	M6	100	82	10
34910007	M7	100	82	10
34910008	M8	100	82	10
34910009	M9	100	106	10
349100095 ^{NEW}	M9.5	100	108	10
34910010	M10	100	122	10
34910012	M12	100	150	10
34910013	M13	100	185	10
34910014	M14	100	187	10
34910016	M16	100	237	10
34912009	M9	120	148	10
34912012 ^{NEW}	M12	120	148	10
34914008	M8	140	102	10
34914009	M9	140	134	10
34914010	M10	140	136	10
34914012	M12	140	178	10
34914014	M14	140	286	10
34914010V	M10	140	134	10
34924806	M6	248	125	10
34924807	M7	248	149	10
34924808	M8	248	150	10

Ribe socket bit :
 • To remove and fasten cylinder-head retaining bolts on FIAT engines.
 • 34914010V
 Special for Audi engines, and VW-Passat cylinder head screws.

1/2"DR. Ribe tamperproof socket bit



Part no.	size	mm	g	pc/box
34906305T	M5	63	66	10
34906306T	M6	63	68	10
34906307T	M7	63	68	10
34906308T	M8	63	68	10
34906309T	M9	63	81	10
34906310T	M10	63	81	10
34906312T	M12	63	113	10
34906314T	M14	63	140	10
34906316T	M16	63	177	10

1/2"DR. 6pt. Flank socket



Part no.	Socket	mm	g	pc/box
54505	5	38	53	10
545055	5.5	38	53	10
54506	6	38	52	10
54507	7	38	52	10
54508	8	38	50	10
54509	9	38	50	10
54510	10	38	52	10
54511	11	38	52	10
54512	12	38	53	10
54513	13	38	53	10
54514	14	38	55	10
54515	15	38	55	10
54516	16	38	59	10
54517	17	38	65	10
54518	18	38	78	10

545	Socket	mm	g	pc/box
54519	19	38	79	10
54520	20	38	81	10
54521	21	38	95	10
54522	22	38	96	10
54523	23	40	116	10
54524	24	40	117	10
54525	25	43	119	10
54526	26	43	138	10
54527	27	43	144	10
54528	28	43	162	10
54529	29	43	162	10
54530	30	45	173	10
54531	31	45	174	10
54532	32	45	176	10
54533	33	47	265	10
54534	34	47	267	10
54535	35	48	267	10
54536	36	48	266	10
5451.4	1/4"	38	45	10
5455.16	5/16"	38	50	10
5453.8	3/8"	38	53	10
5457.16	7/16"	38	53	10
54515.32	15/32"	38	53	10
5451.2	1/2"	38	54	10
5459.16	9/16"	38	55	10
54519.32	19/32"	38	55	10
5455.8	5/8"	38	60	10
54511.16	11/16"	38	63	10
5453.4	3/4"	38	70	10
54525.32	25/32"	38	79	10
54513.16	13/16"	38	79	10
5457.8	7/8"	38	96	10
54515.16	15/16"	40	109	10
5451.0	1"	43	140	10
5451.1.16	1-1/16"	43	144	10
5451.1.8	1-1/8"	45	147	10
5451.3.16	1-3/16"	45	168	10
5451.1.4	1-1/4"	45	184	10

1/2"DR. 6pt. Flank deep socket



54577	Socket	mm	g	pc/box
5457706 ^{NEW}	6	77	70	10
5457707 ^{NEW}	7	77	71	10
5457708	8	77	73	10
5457709	9	77	77	10
5457710	10	77	79	10
5457711	11	77	81	10
5457712	12	77	86	10
5457713	13	77	94	10
5457714	14	77	105	10
5457715	15	77	111	10
5457716	16	77	122	10
5457717	17	77	132	10
5457718	18	77	157	10
5457719	19	77	163	10
5457720	20	77	171	10
5457721	21	77	207	10
5457722	22	77	220	10
5457723	23	77	236	10
5457724	24	77	243	10
5457725	25	77	254	10
5457726	26	77	289	10
5457727	27	77	297	10
5457728	28	77	317	10
5457729	29	77	333	10
5457730	30	77	352	10
5457731	31	77	384	10
5457732	32	77	420	10
545775.16	5/16"	77	77	10
545773.8	3/8"	77	79	10
545777.16	7/16"	77	81	10
545771.2	1/2"	77	94	10
545779.16	9/16"	77	105	10
545775.8	5/8"	77	122	10
5457711.16	11/16"	77	132	10
545773.4	3/4"	77	163	10
5457713.16	13/16"	77	207	10
545777.8	7/8"	77	220	10
5457715.16	15/16"	77	243	10
545771.0	1"	77	254	10
545771.1.16	1-1/16"	77	297	10
545771.1.8	1-1/8"	77	333	10
545771.3.16	1-3/16"	77	384	10
545771.1.4	1-1/4"	77	420	10

1/2"DR. Star socket



546				
Part no.	Socket	mm	g	pc/box
54608	E8	38	50	10
54610	E10	38	52	10
54611	E11	38	52	10
54612	E12	38	5	10
54614	E14	38	55	10
54616	E16	38	57	10
54618	E18	38	59	10
54620	E20	38	64	10
54622	E22	38	85	10
54624	E24	40	100	10

1/2"DR. Star deep socket

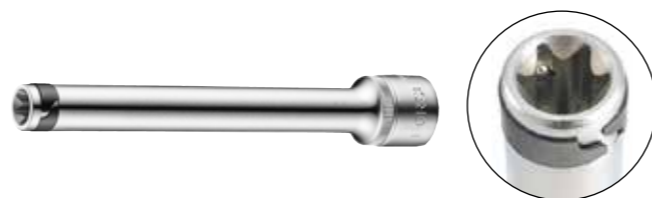

546150...B				
Part no.	Socket	mm	g	pc/box
54615010B	E10	150	152	10
54615012B	E12	150	153	10
54615014B	E14	150	155	10
54615016B	E16	150	158	10
54615018B	E18	150	160	10
54615020B	E20	150	163	10

1/2"DR. Surface drive socket



547				
Part no.	Socket	mm	g	pc/box
54708	8	38	50	10
54709	9	38	50	10
54710	10	38	51	10
54711	11	38	51	10
54712	12	38	51	10
54713	13	38	53	10
54714	14	38	55	10
54715	15	38	58	10
54716	16	38	58	10
54717	17	38	63	10
54718	18	38	77	10
54719	19	38	79	10
54720	20	38	79	10
54721	21	38	94	10
54722	22	38	94	10
54723	23	40	103	10
54724	24	40	109	10
54725	25	42	114	10
54726	26	43	121	10
54727	27	43	139	10

1/2"DR. Star deep socket



54677				
Part no.	Socket	mm	g	pc/box
5467708	E8	77	65	10
5467710	E10	77	84	10
5467711	E11	77	88	10
5467712	E12	77	93	10
5467714	E14	77	98	10
5467716	E16	77	119	10
5467718	E18	77	129	10
5467720	E20	77	171	10
5467722	E22	77	186	10
5467724	E24	77	227	10

547				
Part no.	Socket	mm	g	pc/box
54728	28	43	146	10
54729	29	43	153	10
54730	30	45	167	10
54732	32	45	176	10
5475.16	5/16"	38	50	10
5473.8	3/8"	38	51	10
5477.16	7/16"	38	51	10
54715.32	15/32"	38	51	10
5471.2	1/2"	38	53	10
5479.16	9/16"	38	55	10
54719.32	19/32"	38	58	10
5475.8	5/8"	38	58	10
54711.16	11/16"	38	63	10
5473.4	3/4"	38	77	10
54725.32	25/32"	38	79	10
54713.16	13/16"	38	79	10
5477.8	7/8"	38	94	10
54715.16	15/16"	40	103	10
5471.0	1"	43	118	10
5471.1.16	1-1/16"	43	139	10
5471.1.8	1-1/8"	45	152	10
5471.3.16	1-3/16"	45	167	10
5471.1.4	1-1/4"	45	174	10

1/2"DR. Surface drive deep socket



54777				
Part no.	Socket	mm	g	pc/box
5477708	8	77	73	10
5477709	9	77	77	10
5477710	10	77	79	10
5477711	11	77	81	10
5477712	12	77	86	10
5477713	13	77	94	10
5477714	14	77	105	10

54777				
Part no.	Socket	mm	g	pc/box
5477715	15	77	111	10
5477716	16	77	122	10
5477717	17	77	132	10
5477718	18	77	157	10
5477719	19	77	163	10
5477720	20	77	171	10
5477721	21	77	207	10
5477722	22	77	220	10
5477723	23	77	236	10
5477724	24	77	243	10
5477725	25	77	250	10
5477726	26	77	289	10
5477727	27	77	297	10
5477728	28	77	317	10
5477729	29	77	304	10
5477730	30	77	352	10
5477732	32	77	420	10

1/2"DR. 12pt. Whitworth (WW) socket



548W				
Part no.	Socket	mm	g	pc/box
548W3.16	3/16"	38	50	10
548W1.4	1/4"	38	52	10
548W5.16	5/16"	38	52	10
548W3.8	3/8"	38	72	10
548W7.16	7/16"	38	86	10
548W1.2	1/2"	40	102	10
548W9.16	9/16"	43	110	10
548W5.8	5/8"	45	146	10
548W3.4	3/4"	45	230	10

1/2"DR. 12pt. Flank socket



549				
Part no.	Socket	mm	g	pc/box
54906 <small>NEW</small>	6	38	44	10
54907 <small>NEW</small>	7	38	47	10
54908	8	38	51	10
54909	9	38	51	10
54910	10	38	51	10
54911	11	38	52	10
54912	12	38	52	10
54913	13	38	52	10
54914	14	38	54	10
54915	15	38	53	10
54916	16	38	58	10
54917	17	38	64	10
54918	18	38	80	10
54919	19	38	81	10
54920	20	38	86	10
54921	21	38	94	10
54922	22	38	94	10
54923	23	40	108	10
54924	24	40	108	10
54925	25	43	117	10
54926	26	43	124	10
54927	27	43	135	10
54928	28	43	138	10
54929	29	43	165	10
54930	30	45	168	10
54931	31	45	171	10
54932	32	45	176	10
5491.4	1/4"	38	44	10
5495.16	5/16"	38	50	10
5493.8	3/8"	38	51	10
5497.16	7/16"	38	51	10
54915.32	15/32"	38	51	10
5491.2	1/2"	38	53	10
5499.16	9/16"	38	55	10
54919.32	19/32"	38	58	10
5495.8	5/8"	38	58	10
54911.16	11/16"	38	63	10
5493.4	3/4"	38	77	10
54925.32	25/32"	38	79	10
54913.16	13/16"	38	79	10
5497.8	7/8"	38	94	10
54915.16	15/16"	40	103	10
5491.0	1"	43	118	10
5491.1.16	1-1/16"	43	139	10
5491.1.8	1-1/8"	45	152	10
5491.3.16	1-3/16"	45	167	10
5491.1.4	1-1/4"	45	174	10

1/2"DR. 12pt. Flank deep socket



54977				
Part no.	Socket	mm	g	pc/box
5497708	8	77	71	10
5497709	9	77	71	10
5497710	10	77	71	10
5497711	11	77	76	10
5497712	12	77	84	10
5497713	13	77	93	10
5497714	14	77	100	10
5497715	15	77	100	10
5497716	16	77	100	10
5497717	17	77	117	10
5497718	18	77	143	10
5497719	19	77	149	10
5497720	20	77	154	10
5497721	21	77	183	10
5497722	22	77	193	10
5497723	23	77	212	10
5497724	24	77	248	10
5497725	25	77	239	10
5497726	26	77	275	10
5497727	27	77	270	10
5497728	28	77	300	10
5497729	29	77	281	10
5497730	30	77	290	10
5497731	31	77	292	10
5497732	32	77	303	10
549775.16	5/16"	77	70	10
549773.8	3/8"	77	71	10
549777.16	7/16"	77	75	10
549771.2	1/2"	77	95	10
549779.16	9/16"	77	97	10
549775.8	5/8"	77	98	10
5497711.16	11/16"	77	121	10
549773.4	3/4"	77	148	10
5497713.16	13/16"	77	168	10
549777.8	7/8"	77	196	10
5497715.16	15/16"	77	220	10
549771.0	1"	77	241	10
549771.1.16	1-1/16"	77	270	10
549771.1.8	1-1/8"	77	301	10
549771.3.16	1-3/16"	77	292	10
549771.1.4	1-1/4"	77	307	10

1/2"DR. Spline socket



54Q									
Part no.	size	6point	12point	SAE	E-Torx	XZN	mm	g	pc/box
54Q08	8	8	8		E10		38	44	10
54Q09	9	9	9		E11		38	44	10
54Q10	10	10	10	3/8"	E12	10	38	46	10
54Q11	11	11	11	7/16"	E14	11	38	46	10
54Q12	12	12	12	15/32"		12	38	48	10
54Q13	13	13	13	1/2"	E16		38	50	10
54Q14	14	14	14	9/16"	E18	14	38	52	10
54Q15	15	15	15	19/32"			38	56	10
54Q16	16	16	16	5/8"	E20	16	38	58	10
54Q17	17	17	17	21/32"			38	72	10
54Q18	18	18	18	11/16"	E22	18	38	78	10
54Q19	19	19	19	3/4"	E24		38	80	10
54Q20	20	20	20	25/32"		20	38	82	10
54Q21	21	21	21	13/16"	E26		38	82	10
54Q22	22	22	22	7/8"	E28	22	38	86	10
54Q23	23	23	23	29/32"			40	100	10
54Q24	24	24	24	15/16"	E30	24	40	112	10
54Q25	25	25	25	31/32"	E32		42	125	10
54Q26	26	26	26	1"			42	140	10
54Q27	27	27	27	1-1/16"	E34		43	170	10
54Q28	28	28	28	1-3/32"	E36		43	180	10
54Q30	30	30	30	1-1/8"	E38	30	45	210	10
54Q32	32	32	32	1-1/4"	E40	32	45	230	10

1/2"DR. Spline deep socket



54Q77									
Part no.	size	6point	12point	SAE	E-Torx	XZN	mm	g	pc/box
54Q7708	8	8	8		E10		77	100	10
54Q7709	9	9	9		E11		77	100	10
54Q7710	10	10	10	3/8"	E12	10	77	100	10
54Q7711	11	11	11	7/16"	E14	11	77	103	10
54Q7712	12	12	12	15/32"		12	77	105	10
54Q7713	13	13	13	1/2"	E16		77	107	10
54Q7714	14	14	14	9/16"	E18	14	77	118	10
54Q7715	15	15	15	19/32"			77	125	10
54Q7716	16	16	16	5/8"	E20	16	77	140	10
54Q7717	17	17	17	21/32"			77	150	10
54Q7718	18	18	18	11/16"	E22	18	77	165	10
54Q7719	19	19	19	3/4"	E24		77	178	10
54Q7720	20	20	20	25/32"		20	77	180	10
54Q7721	21	21	21	13/16"	E26		77	185	10
54Q7722	22	22	22	7/8"	E28	22	77	205	10
54Q7723	23	23	23	29/32"			77	245	10
54Q7724	24	24	24	15/16"	E30	24	77	252	10
54Q7726	26	26	26	1"			77	310	10
54Q7727	27	27	27	1-1/16"	E34		77	345	10
54Q7728	28	28	28	1-3/32"	E36		77	365	10
54Q7730	30	30	30	1-1/8"	E38	30	77	400	10
54Q7732	32	32	32	1-1/4"	E40	32	77	410	10

1/2"DR. Universal 6pt. flank socket



80545				
Part no.	Socket	mm	g	pc/box
8054513	13	67	131	10
8054514	14	67	136	10
8054515	15	67	136	10
8054516	16	67	137	10
8054517	17	67	137	10
8054518	18	67	144	10
8054519	19	67	151	10
8054520	20	67	151	10
8054521	21	67	151	10
8054522	22	67	155	10
8054524	24	67	168	10
805451.2	1/2"	67	130	10
805459.16	9/16"	67	135	10
805455.8	5/8"	67	136	10
8054511.16	11/16"	67	137	10
805453.4	3/4"	67	151	10
8054513.16	13/16"	67	151	10
805457.8	7/8"	67	153	10
8054515.16	15/16"	67	167	10

1/2"DR. Universal 6pt. flank deep socket



80545108				
Part no.	Socket	mm	g	pc/box
8054510813	13	108	172	10
8054510814	14	108	179	10
8054510815	15	108	186	10
8054510817	17	108	201	10
8054510819	19	108	222	10
8054510821	21	108	255	10
8054510822	22	108	266	10
8054510824	24	108	283	10
805451081.2	1/2"	108	173	10
805451089.16	9/16"	108	175	10
805451085.8	5/8"	108	179	10
8054510811.16	11/16"	108	192	10
805451083.4	3/4"	108	216	10
8054510813.16	13/16"	108	259	10
805451087.8	7/8"	108	266	10
8054510815.16	15/16"	108	283	10

1/2"DR. Universal star socket



80546				
Part no.	Socket	mm	g	pc/box
8054608	E8	65	124	10
8054610	E10	65	124	10
8054611	E11	65	125	10
8054612	E12	65	127	10
8054614	E14	65	127	10
8054616	E16	65	133	10
8054618	E18	65	133	10
8054620	E20	65	177	10
8054624	E24	65	177	10

1/2"DR. Spark plug socket



8074				
Part no.	size	mm	g	pc/box
807414	14	65	65	10
807416	16	65	92	10
807418	18	65	133	10
807420.6	20.6	65	156	10

1/2"DR. Magnetic spark plug socket



8074...M				
Part no.	size	mm	g	pc/box
807414M	14	70	67	10
807416M	16	70	83	10
807418M	18	70	135	10
807420.6M	20.6	70	153	10

1/2"DR. Swivel handle



8014			
Part no.	mm	g	pc/box
8014250	250-10"	516	5
8014380	380-15"	772	5
8014430	430-17"	886	5

• Spare part available



1/2"DR. Heavy duty swivel handle



8014600			
Part no.	mm	g	pc/ctn
8014600	600-24"	1400	12

• Spare part available



1/2"DR. QR pear ratchet handle 24teeth



80242			
Part no.	mm	g	pc/box
80242	275	754	1

• Spare part available



1/2"DR. QR thin pear ratchet handle 24teeth



80243			
Part no.	mm	g	pc/box
80243	265	618	1

• Spare part available



1/2"DR. QR thin pear ratchet handle 24teeth



80244			
Part no.	mm	g	pc/box
80244	245	644	1

• Spare part available



1/2"DR. QR pear ratchet handle 36teeth



80245			
Part no.	mm	g	pc/box
80245	251	600	1

• Spare part available



1/2"DR. QR pear ratchet handle 72teeth

NEW



80248	<i>l</i>		
Part no.	mm	g	pc/box
80248	265	608	1

• Spare part available

1/2"DR. QR pear ratchet handle 36teeth



802415	<i>l</i>		
Part no.	mm	g	pc/box
802415	255	636	1

• Spare part available

1/2"DR. Flexible round ratchet handle 72teeth



802423	<i>l</i>		
Part no.	mm	g	pc/box
802423	312	656	1

• Spare part available

1/2"DR. Adjustable swivel ratchet handle 24teeth

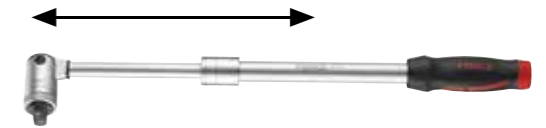

Turn-lock design

802434	<i>l</i>	<i>l</i>		
Part no.	Normal (mm)	Extended (mm)	g	pc/box
802434	435	685	1330	1

• Spare part available

1/2"DR. Round ratchet handle 72teeth



80249	<i>l</i>		
Part no.	mm	g	pc/box
80249	270	524	1

• Spare part available

1/2"DR. QR flexible pear ratchet handle 36teeth



802418	<i>l</i>		
Part no.	mm	g	pc/box
802418	306	798	1
802418L	447	1076	1

• Spare part available

1/2"DR. QR stubby pear ratchet handle 45teeth



802426	<i>l</i>		
Part no.	mm	g	pc/box
802426	130	397	1

• Spare part available

1/2"DR. Sliding T handle

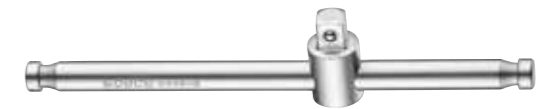

8034	<i>l</i>		
Part no.	mm	g	pc/box
8034125	125-5"	147	10
8034250	250-10"	379	10
8034300	300-12"	445	10

1/2"DR. Square hole ratchet handle



802412	<i>l</i>		
Part no.	mm	g	pc/box
802412	270	558	1

• 1/2" Square driver (802412D) is not included.
• It's an optional item.

1/2"DR. Round ratchet handle 72teeth



802422	<i>l</i>		
Part no.	mm	g	pc/box
802422	267	517	1

• Spare part available

1/2"DR. QR curved-shank ratchet handle 36teeth

NEW



802427	<i>l</i>		
Part no.	mm	g	pc/box
802427	263	588	1

• Spare part available

1/2"DR. Locking sliding T handle

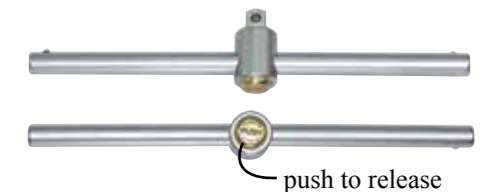

push to release

8034250L	<i>l</i>		
Part no.	mm	g	pc/box
8034250L	250-10"	357	10

1/2"DR. Adjustable handle (turn-lock design)



Part no.	l mm	g	pc/box
8334300	315	496	2

1/2"DR. QR pear ratchet handle 36teeth



Part no.	l mm	g	pc/box
802433	330	765	2

Assembly:

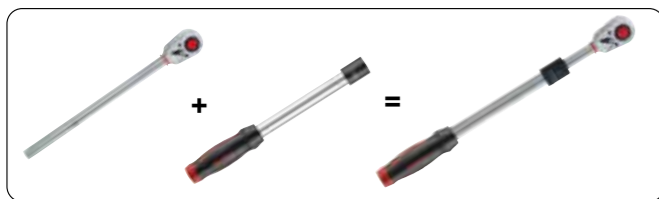

• Spare part available

1/2"DR. Sliding T handle



Part no.	l mm	g	pc/box
803A4300	300	570	5

Assembly:

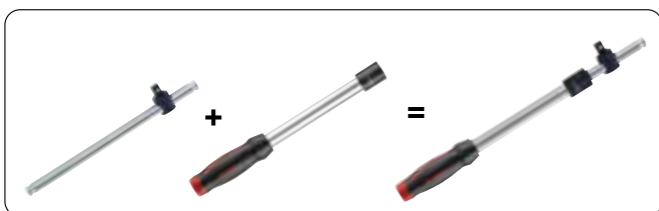

1/2"DR. L handle



Part no.	l mm	g	pc/box
815A4315	315	530	5

Assembly:

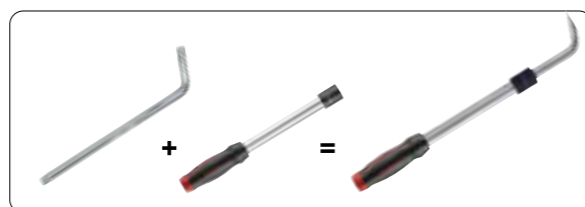

1/2"DR. Extension



Part no.	l mm	g	pc/box
8044			
8044050	50-2"	101	10
8044075	75-3"	141	10
8044100	100-4"	181	10
8044125	125-5"	225	10
8044150	150-6"	257	10
8044200 NEW	200-8"	343	10
8044250	250-10"	438	5
8044300 NEW	300-12"	512	5
8044380	380-15"	606	5
8044450	450-18"	766	10
8044500	500-20"	806	30
8044600	600-24"	1008	15
8044750	750-30"	1260	20
8044900	900-36"	1508	15

1/2"DR. Thin extension



Part no.	l mm	g	pc/box
8044...R			
8044075R	75-3"	128	10
8044125R	125-5"	192	10
8044250R	250-10"	342	5

1/2"DR. Wobble Extension



Part no.	l mm	g	pc/box
8044...W			
8044050W	50-2"	92	10
8044075W	75-3"	122	10
8044125W	125-5"	185	10
8044175W	175-7"	241	10
8044200W	200-8"	280	10
8044250W	250-10"	346	5
8044400W NEW	400-16"	515	10
8044600W NEW	600-24"	754	15

1/2"DR. Extension with light



Part no.	l mm	g	pc/ctn
8044080L	80	360	60

1/2"DR. Locking extension



Part no.	l mm	g	pc/box
8084			
808405	125-5"	227	5
808410	250-10"	408	5

1/2"DR. Universal extension



Part no.	l mm	g	pc/box
80454430	430-17"	1042	5

1/2"DR. Universal joint



Part no.	l mm	g	pc/box
80541	70	149	10

Adapter for 1/2"DR. extension



Part no.	Size	l mm	g	pc/box
80634	3/8"(F) x 1/2"(M)	46	70	10

1/2"DR. Adapter



8094				
Part no.	size	mm	g	pc/box
80942	1/2"(F) x 1/4"(M)	36	64	10
80943	1/2"(F) x 3/8"(M)	36	65	10
80946	1/2"(F) x 3/4"(M)	50	163	10

1/2"DR. L handle



8154				
Part no.	size	mm	g	pc/box
8154190	1/2"DR.	190	351	5
8154260	1/2"DR.	260	470	5

1/2"DR. Socket rail



8194			
Part no.	PCS	mm	g
819405	5	160	27
819409	9	260	44
819420	20	560	144

1/2"DR. Plastic hanger



8164			
Part no.	size	mm	g
8164	1/2"DR.	75	6

1/2"DR. Long adapter



80943066				
Part no.	size	mm	g	pc/box
80943066	1/2"(F) x 3/8"(M)	66	91	10

1/2"DR. Speed handle



8154410A				
Part no.	size	mm	g	pc/ctn
8154410A	1/2"	415	638	20

1/2"DR. Plastic hanger



PI8024			
Part no.	size	mm	g
PI8024	1/2"DR.	155	18

1/2"DR. Bit holder



8104				
Part no.	size	mm	g	pc/box
81042	1/2"DR.x1/4"(F)	38	53	10
81045	1/2"DR.x5/16"(F)	38	57	10
81047	1/2"DR.x10mm(F)	38	57	10
810414	1/2"DR.x14mm(F)	38	90	10

1/2"DR. Speed T handle



8194T			
Part no.	mm	g	pc/box
8194T	300	686	10

1/2"DR. Plastic hanger



PI8034			
Part no.	size	mm	g
PI8034	1/2"DR.	107	12

7pc 3/4"DR. Socket bit set



K6072 12/31.7/32.7/1.4' 2.64kg

	5pc	T60; T70; T80; T90; T100 (80mmL)
	2pc	M16; M18 (80mmL)

18pc 3/4"DR. Socket combination set



6181 1/13.0/14.0/0.5' 13kg

	14pc	19; 21; 22; 24; 27; 30; 32; 33; 34; 35; 36; 38; 41; 46 mm
	1pc	QR pear ratchet handle 24teeth (8026500)
	2pc	8"(200mm); 16"(400mm)
	1pc	20"(500mm)

14pc 3/4"DR. Socket combination set



6141 1/11.0/12.0/0.46' 11kg

	10pc	22; 24; 27; 30; 32; 36; 38; 41; 46; 50 mm
	1pc	QR pear ratchet handle 24teeth (8026500)
	2pc	4"(100mm); 8"(200mm)
	1pc	18"(450mm)

20pc 3/4"DR. Socket combination set



6201 1/12.5/13.5/0.5' 12.5kg

	16pc	19; 21; 22; 23; 24; 26; 27; 29; 30; 32; 35; 36; 38; 41; 46; 50 mm
	1pc	QR pear ratchet handle 24teeth (8026500)
	2pc	4"(100mm); 8"(200mm)
	1pc	18"(450mm)

6141-5 1/11.0/12.0/0.46' 11kg

Changed items		10pc	22; 24; 27; 30; 32; 36; 38; 41; 46; 50 mm
---------------	--	------	---

6201-5 1/12.5/13.5/0.5' 12.5kg

Changed items		16pc	19; 21; 22; 23; 24; 26; 27; 29; 30; 32; 35; 36; 38; 41; 46; 50 mm
---------------	--	------	---

14pc 3/4"DR. Socket combination set



6141B 2/20.7/21.7/1.6' 10.4kg

	10pc	22; 24; 27; 30; 32; 36; 38; 41; 46; 50 mm
	1pc	QR pear ratchet handle 24teeth (8026500)
	2pc	4"(100mm); 8"(200mm)
	1pc	18"(450mm)

21pc 3/4"DR. Socket combination set



6212 2/26.0/27.0/1.5' 13kg

	16pc	19; 21; 22; 23; 24; 26; 27; 29; 30; 32; 35; 36; 38; 41; 46; 50 mm
	1pc	QR pear ratchet handle 24teeth (8026500)
	3pc	4"(100mm); 8"(200mm); 16"(400mm)
	1pc	18"(450mm)

6141B-5 2/20.7/21.7/1.6' 10.4kg

Changed items		10pc	22; 24; 27; 30; 32; 36; 38; 41; 46; 50 mm
---------------	--	------	---

6212-5 2/26.0/27.0/1.5' 13kg

Changed items		16pc	19; 21; 22; 23; 24; 26; 27; 29; 30; 32; 35; 36; 38; 41; 46; 50 mm
---------------	--	------	---

23pc 3/4"DR. Socket combination set

NEW



6233 1/15.0/16.0/0.6' 15kg

	17pc	19; 21; 22; 24; 27; 28; 30; 32; 33; 34; 35; 36; 38; 41; 46; 50; 55 mm
	1pc	QR pear ratchet handle 24teeth (8026500)
	3pc	5"(125mm); 8"(200mm); 16"(400mm)
	1pc	18"(450mm)
	1pc	1/2"(F)x3/4"(M)

6233-5 1/15.0/16.0/0.6' 15kg

Changed items

	17pc	19; 21; 22; 24; 27; 28; 30; 32; 33; 34; 35; 36; 38; 41; 46; 50; 55 mm
--	------	---

24pc 3/4"DR. Socket combination set



6241 2/26.0/27.0/1.5' 13kg

	16pc	19; 21; 22; 23; 24; 27; 30; 32; 34 36; 38; 41; 46; 50; 55; 60 mm
	4pc	14; 17; 19; 22 mm (80mmL)
	1pc	QR adjustable pear ratchet handle 48teeth (8026820)
	2pc	4"(100mm); 8"(200mm)
	1pc	20"(500mm)

6241-5 2/26.0/27.0/1.5' 13kg

Changed items

	16pc	19; 21; 22; 23; 24; 27; 30; 32; 34 36; 38; 41; 46; 50; 55; 60 mm
--	------	--

24pc 3/4"DR. Socket combination set



6241-72 2/26.0/27.0/1.5' 13kg

	16pc	19; 21; 22; 23; 24; 27; 30; 32; 34 36; 38; 41; 46; 50; 55; 60 mm
	4pc	14; 17; 19; 22 mm (80mmL)
	1pc	QR round ratchet handle 72teeth (8026505)
	2pc	4"(100mm); 8"(200mm)
	1pc	20"(500mm)

6241-72-5 2/26.0/27.0/1.5' 13kg

Changed items

	16pc	19; 21; 22; 23; 24; 27; 30; 32; 34 36; 38; 41; 46; 50; 55; 60 mm
--	------	--

14pc 3/4"DR. 12pt. Flank socket combination set (SAE)



6141S 1/11.0/12.0/0.46' 11kg

	10pc	7/8"; 15/16"; 1"; 1-1/8"; 1-1/4"; 1-7/16"; 1-1/2"; 1-5/8"; 1-3/4"; 2"
	1pc	QR pear ratchet handle 24teeth (8026500)
	2pc	4"(100mm); 8"(200mm)
	1pc	18" (450mm)

14pc 3/4"DR. 12pt. Flank socket combination set (SAE)



6141SB 2/20.7/21.7/1.6' 10.4kg

	10pc	7/8"; 15/16"; 1"; 1-1/8"; 1-1/4"; 1-7/16"; 1-1/2"; 1-5/8"; 1-3/4"; 2"
	1pc	QR pear ratchet handle 24teeth (8026500)
	2pc	4"(100mm); 8"(200mm)
	1pc	18" (450mm)

20pc 3/4"DR. 12pt. Flank socket combination set (SAE)



6201S 1/12.5/13.5/0.5' 12.5kg

	16pc	7/8"; 15/16"; 1"; 1-1/16"; 1-1/8"; 1-3/16"; 1-1/4"; 1-5/16"; 1-3/8"; 1-7/16"; 1-1/2"; 1-5/8"; 1-3/4"; 1-13/16"; 1-7/8"; 2"
	1pc	QR pear ratchet handle 24teeth (8026500)
	2pc	4"(100mm); 8"(200mm)
	1pc	18"(450mm)

21pc 3/4"DR. 12pt. Flank socket combination set (SAE)



6212S

2/26.0/27.0/1.5' 13kg

	16pc	7/8"; 15/16"; 1"; 1-1/16"; 1-1/8"; 1-3/16"; 1-1/4"; 1-5/16"; 1-3/8"; 1-7/16"; 1-1/2"; 1-5/8"; 1-3/4"; 1-13/16"; 1-7/8"; 2"
	1pc	QR pear ratchet handle 24teeth (8026500)
	3pc	4"(100mm); 8"(200mm); 16"(400mm)
	1pc	18"(450mm)

26pc 3/4"DR. 12pt. Flank socket combination set (S&M)



6261

2/30.0/31.0/1.5' 15kg

	10pc	22; 24; 27; 30; 32; 36; 38; 41; 46; 50 mm
	12pc	7/8"; 15/16"; 1"; 1-1/8"; 1-3/16"; 1-5/16"; 1-3/8"; 1-7/16"; 1-5/8"; 1-3/4"; 1-7/8"; 2"
	1pc	QR pear ratchet handle 24teeth (8026500)
	2pc	4"(100mm); 8"(200mm)
	1pc	18"(450mm)

29pc 3/4"DR. 12pt. Flank socket combination set (S&M)

NEW



6291

1/19.2/20.2/0.5' 19.2kg

	12pc	19; 22; 24; 27; 30; 32; 33; 35; 36; 38; 41; 46 mm
	13pc	7/8"; 15/16"; 1"; 1-1/16"; 1-1/8"; 1-3/16"; 1-1/4"; 1-5/16"; 1-3/8"; 1-7/16"; 1-1/2"; 1-5/8"; 1-7/8"
	1pc	QR pear ratchet handle 24teeth (8026500)
	2pc	8"(200mm); 16"(400mm)
	1pc	18"(450mm)

3/4"DR. Hex socket bit



364		<i>l</i>		
Part no.	size	mm	g	pc/box
36408014	14	80	319	3
36408016	16	80	338	3
36408017	17	80	348	3
36408019	19	80	358	3
36408022	22	80	396	3

3/4"DR. Star socket bit



366		<i>l</i>		
Part no.	size	mm	g	pc/box
36608060	T60	80	310	3
36608070	T70	80	314	3
36608080	T80	80	340	3
36608090	T90	80	343	3
366080100	T100	80	370	3

3/4"DR. Spline security socket bit



368...T		<i>l</i>		
Part no.	size	mm	g	pc/box
36808016T	M16T	80	320	3
36808018T	M18T	80	322	3

3/4"DR. 6pt. Flank socket



565		<i>l</i>		
Part no.	size	mm	g	pc/box
56517 NEW	17	50	155	2
56518 NEW	18	50	158	2
56519	19	50	160	2
56520	20	50	160	2
56521	21	50	163	2
56522	22	50	203	2
56523	23	50	203	2
56524	24	51	210	2
56525	25	52	204	2
56526	26	52	234	2
56527	27	52	220	2
56528	28	52	219	2
56529	29	52	239	2
56530	30	54	267	2
56531	31	56	304	2
56532	32	56	289	2
56533	33	56	318	2
56534	34	56	327	2
56535	35	58	380	2
56536	36	58	407	2
56537 NEW	37	58	435	2
56338	38	60	474	2
56539 NEW	39	60	485	2
56540	40	62	501	2
56541	41	64	558	2
56542	42	64	556	2
56543 NEW	43	64	620	2
56544 NEW	44	66	630	2
56545	45	67	660	2
56546	46	68	669	2
56548	48	70	702	2
56550	50	72	812	2
56552	52	74	869	2
56554	54	74	879	2
56555	55	76	948	2
56556 NEW	56	76	940	2
56558	58	78	1050	2
56560	60	78	1117	2
56565	65	82	1311	2

3/4"DR. 12pt. Flank socket



569		<i>l</i>		
Part no.	size	mm	g	pc/box
56917 NEW	17	50	154	2
56918 NEW	18	50	155	2
56919	19	50	157	2
56920	20	50	158	2
56921	21	50	158	2
56922	22	50	198	2
56923	23	50	201	2
56924	24	51	206	2
56925	25	52	200	2
56926	26	52	216	2
56927	27	52	205	2
56928	28	52	209	2
56929	29	52	230	2
56930	30	54	256	2
56931	31	56	270	2
56932	32	56	276	2
56933	33	56	298	2
56934	34	56	315	2
56935	35	58	359	2
56936	36	58	389	2
56937 NEW	37	58	417	2
56938	38	60	440	2
56939 NEW	39	60	453	2
56940 NEW	40	62	463	2
56941	41	64	527	2
56942	42	64	528	2
56943 NEW	43	64	575	2
56944 NEW	44	66	585	2
56945	45	67	615	2
56946	46	68	622	2
56947 NEW	47	68	689	2
56948 NEW	48	70	664	2
56950	50	72	769	2
56952	52	74	789	2
56954	54	74	840	2
56955	55	76	853	2
56956	56	76	840	2
56958 NEW	58	78	960	2
56960	60	78	998	2
56965	65	82	1233	2
56969 NEW	69	86	1370	2

569		<i>l</i>		
Part no.	size	mm	g	pc/box
5693.4	3/4"	50	157	2
56913.16	13/16"	50	205	2
5697.8	7/8"	50	197	2
56915.16	15/16"	51	205	2
5691.0	1"	52	221	2
5691.1.16	1-1/16"	52	205	2
5691.1.8	1-1/8"	52	233	2
5691.3.16	1-3/16"	54	260	2
5691.1.4	1-1/4"	56	279	2
5691.5.16	1-5/16"	56	300	2
5691.3.8	1-3/8"	58	354	2
5691.7.16	1-7/16"	58	392	2
5691.1.2	1-1/2"	60	441	2
5691.9.16	1-9/16"	62	470	2
5691.5.8	1-5/8"	64	515	2
5691.11.16	1-11/16"	65	547	2
5691.3.4	1-3/4"	66	587	2
5691.13.16	1-13/16"	68	627	2
5691.7.8	1-7/8"	70	697	2
5691.15.16	1-15/16"	70	705	2
5692.0	2"	72	750	2
5692.1.16	2-1/16"	72	785	2
5692.1.8	2-1/8"	74	835	2
5692.3.16	2-3/16"	76	848	2
5692.1.4	2-1/4"	76	835	2
5692.5.16	2-5/16"	78	950	2
5692.3.8	2-3/8"	78	990	2
5692.7.16	2-7/16"	80	995	2
5692.1.2	2-1/2"	82	1225	2

3/4"DR. Swivel handle



8016475	<i>l</i>		
Part no.	mm	g	pc/ctn
8016475	475-19"	1900	10

* Spare part available

3/4"DR. Heavy duty swivel handle

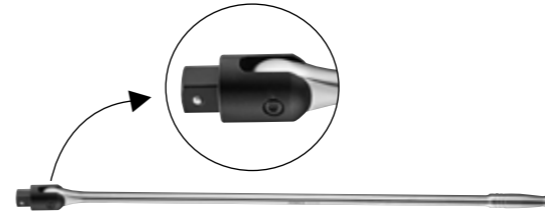

80161000	<i>l</i>		
Part no.	mm	g	pc/ctn
80161000	1000-40"	3670	6

* Spare part available

3/4"DR. QR pear ratchet handle 24teeth



8026500	<i>l</i>		
Part no.	mm	g	pc/ctn
8026500	500-20"	1970	10

* Spare part available

3/4"DR. QR round ratchet handle 72teeth



8026505	<i>l</i>		
Part no.	mm	g	pc/ctn
8026505	500	2800	5

* Spare part available

3/4"DR. QR adjustable pear ratchet handle 48teeth

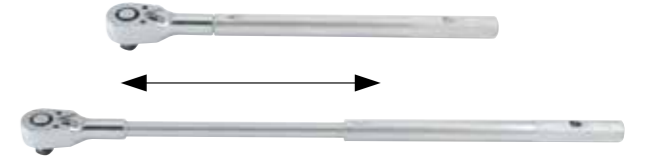

8026820	<i>l</i>	<i>l</i>		
Part no.	Normal(mm)	Extended(mm)	g	pc/ctn
8026820	520	820	3168	10

* Spare part available

3/4"DR. Sliding T handle



8036	<i>l</i>		
Part no.	mm	g	pc/ctn
8036450	450-18"	1388	10
8036500	500-20"	1514	10

3/4"DR. Locking sliding T handle

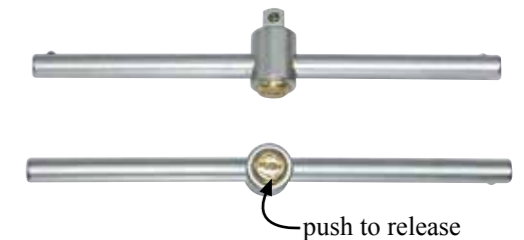

8036450L	<i>l</i>		
Part no.	mm	g	pc/ctn
8036450L	450-18"	1350	10

3/4"DR. Extension



8046	<i>l</i>		
Part no.	mm	g	pc/ctn
8046100	100-4"	417	40
8046125	125-5"	505	40
8046200	200-8"	740	30
8046400	400-16"	1358	15
8046600 <small>NEW</small>	600-24"	1628	10

3/4"DR. Adapter



8096		<i>l</i>		
Part no.	size	mm	g	pc/box
80964	3/4"(F)x1/2"(M)	58	308	5
80968	3/4"(F)x1"(M)	68	407	2

3/4"DR. Locking extension



8086	<i>l</i>		
Part no.	mm	g	pc/ctn
8086100	100-4"	460	40
8086200	200-8"	809	30
8086400	400-16"	1598	15

3/4"DR. L handle



8156	<i>l</i>		
Part no.	mm	g	pc/ctn
8156330	330	1520	10
8156450	450	1990	10

3/4"DR. Universal joint



80561	<i>l</i>		
Part no.	mm	g	pc/box
80561	109	625	2

3/4"DR. Plastic hanger



8166		<i>l</i>	
Part no.	size	mm	g
8166	3/4"DR.	95	11



14pc 1"DR. 12pt. Flank socket combination set



8141 1/26.8/27.8/0.83' 26.8kg

	10pc	36; 41; 46; 50; 55; 60; 65; 70; 75; 80 mm
	1pc	Pear ratchet head 24teeth (80281) (+ handle bar 8008550 = 8028650)
	2pc	8"(200mm); 16"(400mm)
	1pc	22"(550mm) (adaptor 80381 + handle bar 8008550)

21pc 1"DR. 12pt. Flank socket combination set



8211 1/35.5/36.5/1.1' 35.5kg

	17pc	36; 38; 41; 46; 50; 54; 55; 58; 60; 63; 65; 67; 70; 71; 75; 77; 80 mm
	1pc	Pear ratchet head 24teeth (80281) (+ handle bar 8008550 = 8028650)
	2pc	8"(200mm); 16"(400mm)
	1pc	22"(550mm) (adaptor 80381 + handle bar 8008550)

14pc 1"DR. 12pt. Flank socket combination set (SAE)



8141S 1/26.8/27.8/0.83' 26.8kg

	10pc	1-7/16"; 1-1/2"; 1-11/16"; 1-7/8"; 2"; 2-1/4"; 2-3/8"; 2-5/8"; 2-15/16"; 3-1/8"
	1pc	Pear ratchet head 24teeth (80281) (+ handle bar 8008550 = 8028650)
	2pc	8"(200mm); 16"(400mm)
	1pc	22"(550mm) (adaptor 80381 + handle bar 8008550)

21pc 1"DR. 12pt. Flank socket combination set (SAE)



8211S 1/35.5/36.5/1.1' 35.5kg

	17pc	1-7/16"; 1-1/2"; 1-5/8"; 1-11/16"; 1-3/4"; 1-13/16"; 1-7/8"; 2"; 2-1/8"; 2-3/16"; 2-1/4"; 2-3/8"; 2-1/2"; 2-5/8"; 2-3/4"; 2-15/16"; 3-1/8"
	1pc	Pear ratchet head 24teeth (80281) (+ handle bar 8008550 = 8028650)
	2pc	8"(200mm); 16"(400mm)
	1pc	22"(550mm) (adaptor 80381 + handle bar 8008550)

1"DR. 6pt. Flank socket



585

Part no.	size	mm	g	pc/box
58548 NEW	48	75	995	2
58550 NEW	50	75	1010	2
58552 NEW	52	75	1033	2
58554 NEW	54	80	1143	2
58555 NEW	55	80	1224	2
58558 NEW	58	80	1258	2
58560	60	84	1455	2
58563 NEW	63	87	1688	2
58565	65	87	1566	2
58570	70	93	2135	1
58571 NEW	71	93	2050	1
58575	75	97	2166	1
58580	80	103	2566	1
58585 NEW	85	106	3119	1
58590 NEW	90	110	4176	1
58595 NEW	95	106	4319	1

1"DR. 12pt. Flank socket



589

Part no.	size	mm	g	pc/box
58935	35	61	414	2
58936	36	65	452	2
58938	38	65	483	2
58940 NEW	40	65	492	2
58941	41	70	552	2
58942 NEW	42	70	540	2
58943 NEW	43	70	673	2
58944 NEW	44	70	758	2
58945 NEW	45	70	769	2
58946	46	75	835	2
58950	50	75	959	2

Part no.	size	mm	g	pc/box
58952 NEW	52	75	1006	2
58954	54	80	1105	2
58955	55	80	1150	2
58958	58	80	1250	2
58960	60	84	1309	2
58963	63	87	1469	2
58965	65	87	1444	2
58967	67	90	1567	1
58970	70	93	1900	1
58971	71	93	1953	1
58975	75	97	2148	1
58977	77	103	2260	1
58980	80	103	2434	1
58985	85	106	2838	1
58990	90	110	3990	1
58995	95	110	4070	1
5891.3.8	1-3/8"	61	365	2
5891.7.16	1-7/16"	65	460	2
5891.1.2	1-1/2"	65	485	2
5891.5.8	1-5/8"	70	542	2
5891.11.16	1-11/16"	70	670	2
5891.3.4	1-3/4"	75	764	2
5891.13.16	1-13/16"	75	800	2
5891.7.8	1-7/8"	75	957	2
5892.0	2"	75	954	2
5892.1.16	2-1/16"	80	1038	2
5892.1.8	2-1/8"	80	1103	2
5892.3.16	2-3/16"	80	1167	2
5892.1.4	2-1/4"	80	1226	2
5892.5.16	2-5/16"	80	1200	2
5892.3.8	2-3/8"	84	1320	2
5892.7.16	2-7/16"	87	1376	2
5892.1.2	2-1/2"	87	1410	2
5892.9.16	2-9/16"	90	1423	1
5892.5.8	2-5/8"	90	1551	1
5892.11.16	2-11/16"	93	1656	1
5892.3.4	2-3/4"	93	1950	1
5892.13.16	2-13/16"	93	1790	1
5892.7.8	2-7/8"	97	2340	1
5892.15.16	2-15/16"	97	2163	1
5893.0	3"	103	2290	1
5893.1.8	3-1/8"	103	2516	1

1"DR. Swivel handle



Part no.	l mm	g	pc/ctn
8018650	650-26"	4122	5

* Spare part available



1"DR. Sliding T handle



Part no.	l mm	g	pc/ctn
8038550	550-22"	3288	5

1"DR. Adapter



Part no.	size	l mm	g	pc/box
80986	1"(F)x3/4"(M)	74	964	2

1"DR. Heavy duty swivel Handle

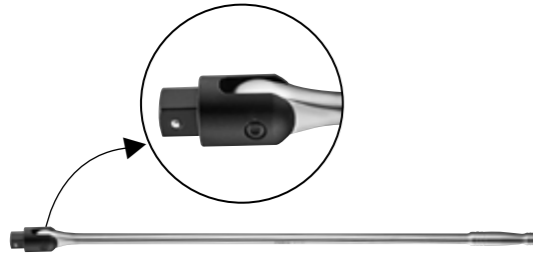

Part no.	l mm	g	pc/ctn
80181000	1000-39"	3785	6

* Spare part available



1"DR. Extension



Part no.	l mm	g	pc/ctn
8048			
8048150	150-6"	1047	12
8048200	200-8"	1330	12
8048400	400-16"	2290	10

1"DR. L handle



Part no.	l mm	g	pc/ctn
8158650	650	4940	4

1"DR. Pear ratchet handle 24teeth



Part no.	l mm	g	pc/ctn
8028650	650-26"	4424	5

8028650=80281(ratchet head)+8008550 (handle bar)

* Spare part available



1"DR. Universal joint



Part no.	l mm	g	pc/box
80581	143	1237	2



1"DR. Plastic hanger





Part no.	size	l mm	g
8168	1"DR	115	18

13pc 1/4"DR. Impact wrench & socket set







K2139  24/21.1/22.1/1.5'  880g

	12pc	4; 4.5; 5; 5.5; 6; 7; 8; 9; 10; 11; 12; 13 mm
	1pc	Palm ratchet impact wrench Max. 33 Nm (82421)

13pc 1/4"DR. Impact wrench & socket set







K2139-2  24/23.2/24.2/1.5'  965g

	12pc	4; 4.5; 5; 5.5; 6; 7; 8; 9; 10; 11; 12; 13 mm
	1pc	Stubby ratchet impact wrench Max. 40.5 Nm (82422)

23pc 1/4"DR. Impact wrench & socket set (S&M)







K2231  24/24.7/25.7/1.5'  1030g

	12pc	4; 4.5; 5; 5.5; 6; 7; 8; 9; 10; 11; 12; 13 mm
	10pc	5/32"; 3/16"; 7/32"; 1/4"; 9/32"; 5/16"; 11/32"; 3/8"; 7/16"; 1/2"
	1pc	Palm ratchet impact wrench Max. 33 Nm (82421)

23pc 1/4"DR. Impact wrench & socket set (S&M)





K2231-2  24/26.9/27.9/1.5'  1120g

	12pc	4; 4.5; 5; 5.5; 6; 7; 8; 9; 10; 11; 12; 13 mm
	10pc	5/32"; 3/16"; 7/32"; 1/4"; 9/32"; 5/16"; 11/32"; 3/8"; 7/16"; 1/2"
	1pc	Stubby ratchet impact wrench Max. 40.5 Nm (82422)



1/4"DR. 6pt. Flank impact socket



425		<i>l</i>		
Part no.	Socket	mm	g	pc/box
42504	4	23	10	50
425045	4.5	23	13	50
42505	5	23	13	50
425055	5.5	23	13	50
42506	6	23	13	50
42507	7	23	14	50
42508	8	23	14	50
42509	9	23	18	50
42510	10	23	24	50
42511	11	23	24	50
42512	12	23	27	50
42513	13	23	32	50
42514	14	23	36	50
4255.32	5/32"	23	10	50
4253.16	3/16"	23	13	50
4257.32	7/32"	23	13	50
4251.4	1/4"	23	13	50
4259.32	9/32"	23	13	50
4255.16	5/16"	23	14	50
42511.32	11/32"	23	14	50
4253.8	3/8"	23	18	50
4257.16	7/16"	23	24	50
4251.2	1/2"	23	32	50
4259.16	9/16"	23	36	50



1/4"DR. Magnetic 6pt. Flank impact socket



42507M		<i>l</i>		
Part no.	Socket	mm	g	pc/box
42507M	7	23	16	50



1/4"DR. 6pt. Flank deep impact socket



42550		<i>l</i>		
Part no.	Socket	mm	g	pc/box
4255008	8	50	31	20
4255009	9	50	29	20
4255010	10	50	39	20
4255011	11	50	42	20
4255012	12	50	45	20

1/4"DR. Star impact socket



426		<i>l</i>		
Part no.	Socket	mm	g	pc/box
42604	E4	23	12	50
42605	E5	23	12	50
42606	E6	23	12	50
42607	E7	23	12	50
42608	E8	23	14	50
42610	E10	23	16	50

1/4"DR. Impact extension (ball type)

NEW



8042...MPB	l	g	pc/box
Part no.	mm	g	pc/box
8042050MPB	50	24	20
8042100MPB	100	45	10

1/4"DR. Impact universal joint (ball type)

NEW



80521MPB	l	g	pc/box
Part no.	mm	g	pc/box
80521MPB	38	33.5	10

1/4"DR. Impact adapter (ball type)



80923MPB	Size	mm	g	pc/box
Part no.				
80923MPB	1/4"(F)x3/8"(M)	27	21	25

1/4"DR. Palm ratchet impact wrench



82421	l	g	pc/box
Part no.	mm	g	pc/box
82421	125-4.9"	450	1

Specifications :

Square Drive	1/4"
Free Speed (R.P.M.)	250
Working Torque Range (ft-lbs) / (Nm)	0-20 / 0-27
Max. Torque (ft-lbs) / (Nm)	25/33
Air Pressure (PSI)	90
AIR Inlet (P.T.)	1/4"
Air Consumption (C.F.M.)	2.4
Sound Pressure Level (dBA)	79.9

1/4"DR. Stubby ratchet impact wrench



82422	l	g	pc/box
Part no.	mm	g	pc/box
82422	165-6.5"	500	1

Specifications :

Square Drive	1/4"
Free Speed (R.P.M.)	240
Working Torque Range (ft-lbs) / (Nm)	5-20 / 7-27
Max. Torque (ft-lbs) / (Nm)	30 / 40.5
Air Pressure (PSI)	90
AIR Inlet (P.T.)	1/4"
Air Consumption (C.F.M.)	2.5

8pc 3/8"DR. 6pt. Flank impact socket set



3083

40/18.7/19.7/0.55' 468g

8pc 8; 10; 11; 12; 13; 14; 17; 19 mm

8pc 3/8"DR. 6pt. Flank deep impact socket set



3084

20/17.7/18.7/0.5' 885g

8pc 8; 10; 11; 12; 13; 14; 17; 19 mm (63mmL)

8pc 3/8"DR. 6pt. Flank impact socket set (SAE)



3083S

40/18.7/19.7/0.55' 468g

8pc 5/16"; 3/8"; 7/16"; 1/2"; 9/16"; 5/8"; 11/16"; 3/4"

8pc 3/8"DR. 6pt. Flank deep impact socket set (SAE)



3084S

20/17.7/18.7/0.5' 885g

8pc 5/16"; 3/8"; 7/16"; 1/2"; 9/16"; 5/8"; 11/16"; 3/4" (63mmL)

7pc 3/8"DR. Hex impact socket bit set (one-piece)

NEW



30716



48/17.6/18.6/1.4' 366g

7pc 4; 5; 6; 7; 8; 10; 12 mm (52mmL)

7pc 3/8"DR. Star impact socket bit set (one-piece)

NEW







30715  48/13.8/14.8/1.4'  286g

	7pc	T20; T25; T27; T30; T40; T45; T50 (52mmL)
---	-----	---

13pc 3/8"DR. Impact wrench & socket set







K3133  24/24.7/25.7/1.5'  1030g

	11pc	6; 7; 8; 10; 11; 12; 13; 14; 15; 17; 19 mm
	1pc	Palm ratchet impact wrench Max. 33 Nm (82432)
	1pc	Ball type 3"(75mm)

13pc 3/8"DR. Impact wrench & socket set











K3133-3  24/26.9/27.9/1.5'  1120g

	11pc	6; 7; 8; 10; 11; 12; 13; 14; 15; 17; 19 mm
	1pc	Stubby ratchet impact wrench Max. 40.5 Nm (82433)
	1pc	Ball type 3"(75mm)

23pc 3/8"DR. Impact wrench & socket set







3233  6/19.8/20.8/1.54'  3.3kg

	10pc	10; 11; 12; 13; 14; 16; 17; 19; 21; 22 mm
	5pc	6; 7; 8; 10; 12 mm (52mmL)
	4pc	T30; T40; T45; T50 (52mmL)
	1pc	Mini impact wrench Max. 711 Nm (82531)
	1pc	Ball type 3"(75mm)
	1pc	Ball type 3/8"
	1pc	Pin type 3/8"(F)x1/2"(M)

3/8"DR. Hex impact socket bit(one-piece)







23452    

Part no.	Socket	mm	g	pc/box
2345204	4	52	35	10
2345205	5	52	38	10
2345206	6	52	41	10
2345207	7	52	43	10
2345208	8	52	47	10
2345210	10	52	57	10
2345212	12	52	66	10
234521.4	1/4"	52	39	10
234523.8	3/8"	52	50	10
234521.2	1/2"	52	66	10

3/8"DR. 6pt. Flank impact socket







435    

Part no.	Socket	mm	g	pc/box
43506	6	32	30	20
43507	7	32	31	20
43508	8	32	32	20
43509	9	32	33	20
43510	10	32	34	20
43511	11	32	36	20
43512	12	32	38	20
43513	13	32	40	20
43514	14	32	51	20
43515	15	32	54	20
43516	16	32	55	20
43517	17	32	55	20
43518	18	32	55	20
43519	19	32	59	20
43520	20	32	60	20
43521	21	32	61	20
43522	22	32	62	20
4353513	13	35	41	20
4355.16	5/16"	32	30	20
4353.8	3/8"	32	31	20
4357.16	7/16"	32	36	20
4351.2	1/2"	32	38	20
4359.16	9/16"	32	51	20
4355.8	5/8"	32	55	20
43511.16	11/16"	32	55	20
4353.4	3/4"	32	59	20
43513.16	13/16"	32	61	20
4357.8	7/8"	32	62	20

3/8"DR. Star impact socket bit(one-piece)



23652    

Part no.	Socket	mm	g	pc/box
2365220	T20	52	25	10
2365225	T25	52	35	10
2365227	T27	52	38	10
2365230	T30	52	38	10
2365240	T40	52	40	10
2365245	T45	52	45	10
2365250	T50	52	50	10

3/8" DR. Magnetic 6pt. Flank impact socket



435...M				
Part no.	Socket	mm	g	pc/box
43508M	8	32	36	20
43510M	10	32	39	20
43512M	12	32	44	20
43513M	13	32	46	20

3/8"DR. 6pt. Flank deep impact socket



43563				
Part no.	Socket	mm	g	pc/box
4356308	8	63	48	20
4356309	9	63	54	20
4356310	10	63	58	20
4356311	11	63	64	20
4356312	12	63	80	20
4356313	13	63	85	20
4356314	14	63	92	20
4356315	15	63	110	20
4356316	16	63	108	20
4356317	17	63	108	20
4356318	18	63	129	20
4356319	19	63	138	20
435635.16	5/16"	63	48	20
435633.8	3/8"	63	58	20
435637.16	7/16"	63	64	20
435631.2	1/2"	63	80	20
435639.16	9/16"	63	92	20
435635.8	5/8"	63	110	20
4356311.16	11/16"	63	108	20
435633.4	3/4"	63	138	20

43578				
Part no.	Socket	mm	g	pc/box
4357808 <small>NEW</small>	8	78	65	20
4357810 <small>NEW</small>	10	78	77	20
4357813 <small>NEW</small>	13	78	100	20

3/8"DR. Star impact socket



436				
Part no.	Socket	mm	g	pc/box
43604	E4	28	31	20
43605	E5	28	31	20
43606	E6	28	31	20
43607	E7	28	31	20
43608	E8	28	32	20
43610	E10	28	32	20
43611	E11	28	32	20
43612	E12	28	34	20
43614	E14	28	37	20

3/8"DR. Extension impact socket



80435				
Part no.	Socket	mm	g	pc/box
8043510010	10	100	100	10
8043510012	12	100	110	10
8043510014	14	100	116	10
8043510016	16	100	123	10
8043515010	10	150	134	10
8043515013 <small>NEW</small>	13	150	143	10
8043515016	16	150	152	10

3/8"DR. Magnetic extension impact socket



80435...M				
Part no.	Socket	mm	g	pc/box
8043510010M	10	100	105	10
8043515010M	10	150	135	10
8043515013M	13	150	147	10

3/8"DR. Impact extension (pin type)



8043...MPP			
Part no.	mm	g	pc/box
8043075MPP	75-3"	76	10
8043150MPP	150-6"	145	10

3/8"DR. Impact extension (ball type)



8043...MPB			
Part no.	mm	g	pc/box
8043075MPB	75-3"	78	10
8043125MPB	125-5"	123	10
8043150MPB	150-6"	147	10
8043200MPB	200-8"	190	10

3/8"DR. Impact universal joint (pin type)



80531MPP			
Part no.	mm	g	pc/box
80531MPP	71	110	10

3/8"DR. Impact universal joint (ball type)



80531MPB			
Part no.	mm	g	pc/box
80531MPB	71	88	10

3/8"DR. Impact adaptor (pin type)



8093...MPP				
Part no.	Size	mm	g	pc/box
80932MPP	3/8"(F) x1/4"(M)	27	50	10
80934MPP	3/8"(F) x1/2"(M)	34	46	10

3/8"DR. Impact adaptor (ball type)



8093...MPB				
Part no.	Size	mm	g	pc/box
80932MPB	3/8"(F) x 1/4"(M)	27	50	10
80934MPB	3/8"(F) x 1/2"(M)	34	46	10

3/8"DR. Impact bit holder



8103...MPB				
Part no.	Size	mm	g	pc/box
81032MPB	3/8"(F) x 1/4"(F)	40	36	20
81035MPB	3/8"(F) x 5/16"(F)	40	49	20

O-ring & Pin for 3/8"DR.



Part no.			
	mm	mm	g
R1335	Ø13- Ø3.5		2
P1425		14L- Ø 2.0	2
R1635	Ø16- Ø3.5		2
P1625		16L- Ø 2.5	2

Part mapping for 3/8"DR.

Tool No.	O-ring	Pin
23452 04...12	R1335	P1425
23452 1.4...1.2	R1335	P1425
23652 20...50	R1335	P1425
435 06...13	R1335	P1425
435 14...22	R1635	P1625
4353513	R1335	P1425
435 5.16...1.2	R1335	P1425
435 9.16...7.8	R1635	P1625
43563 08...13	R1335	P1425
43563 14...19	R1635	P1625
43578 08...13	R1335	P1425
43563 5.16...1.2 4	R1335	P1425
3563 9.16...3.4	R1635	P1625
435 08M...12M	R1335	P1425
43513M	R1635	P1625
436 04...14	R1335	P1425
8043 075MPP...150MPP	R1335	P1425
8043 075MPB...200MPB	R1335	P1425
80435100 10...16	R1335	P1425
80435150 10...16	R1335	P1425
80435 10010M...15013M	R1335	P1425
80531MPP	R1335	P1425
80531MPB	R1335	P1425
8093 2MPP...4MPP	R1335	P1425
8093 2MPB...4MPB	R1335	P1425
8103 2MPB...5MPB	R1335	P1425

3/8"DR. Palm ratchet impact wrench



82432				
Part no.	mm	g	pc/box	
82432	125-4.9"	450	1	

Specifications :

Square Drive	3/8"
Free Speed (R.P.M.)	250
Working Torque Range (ft-lbs) / (Nm)	0-20 / 0-27
Max. Torque (ft-lbs) / (Nm)	25/33
Air Pressure (PSI)	90
AIR Inlet (P.T.)	1/4"
Air Consumption (C.F.M.)	2.4
Sound Pressure Level (dBA)	79.9

3/8"DR. Stubby ratchet impact wrench



82433				
Part no.	mm	g	pc/box	
82433	165-6.5"	500	1	

Specifications :

Square Drive	3/8"
Free Speed (R.P.M.)	240
Working Torque Range (ft-lbs) / (Nm)	5-20 / 7-27
Max. Torque (ft-lbs) / (Nm)	30 / 40.5
Air Pressure (PSI)	90
AIR Inlet (P.T.)	1/4"
Air Consumption (C.F.M.)	2.5
Sound Pressure Level (dBA)	87.7

3/8"DR. Mini impact wrench



82531				
Part no.	mm	g	pc/box	
82531	145-5.7"	1500	1	

Specifications :

Square Drive	3/8"
Free Speed (R.P.M.)	12500
Working Torque Range (ft-lbs) / (Nm)	90-260 / 120-351
Max. Torque (ft-lbs) / (Nm)	525 / 711
Air Pressure (PSI)	90
AIR Inlet (P.T.)	1/4"
Air Consumption (C.F.M.)	4

3/8"DR. Mini composite impact wrench



82532				
Part no.	mm	g	pc/box	
82532	154-6"	1200	1	

Specifications :

Square Drive	3/8"
Free Speed (R.P.M.)	12500
Working Torque Range (ft-lbs) / (Nm)	90-260 / 120-351
Max. Torque (ft-lbs) / (Nm)	525 / 711
Air Pressure (PSI)	90
AIR Inlet (P.T.)	1/4"
Air Consumption (C.F.M.)	4

3/8"DR. Hammer impact drill



82731	l		
Part no.	mm	g	pc/box
82731	185-7.3"	1070	1

Specifications :

Drill Capacity (mm).....	10
Free Speed (R.P.M.).....	2500
Air Pressure (PSI).....	90
AIR Inlet (P.T.).....	1/4"
Air Consumption (C.F.M.).....	8
Reversible.....	Yes

3/8"DR. Hammer impact drill



82733	l		
Part no.	mm	g	pc/box
82733	210-8.3"	870	1

Specifications :

Drill Capacity (mm).....	10
Free Speed (R.P.M.).....	2200
Air Pressure (PSI).....	90
AIR Inlet (P.T.).....	1/4"
Air Consumption (C.F.M.).....	5
Reversible.....	Yes

3pc 1/2"DR. Colored 6pt. flank deep impact socket set



K4032		24/22.3/23.3/1.5'		930g
	3pc	17; 19; 21 mm (85mmL)		

3pc 1/2"DR. Colored 6pt. flank deep impact socket set



4032		24/19.4/20.4/1.4'		808g
	3pc	17; 19; 21 mm (85mmL)		

3pc 1/2"DR. Thin-wall 6pt. flank deep impact socket set



4032TH		24/19.2/20.2/1.1'		800g
	3pc	Thin-wall 17; 19; 21 mm (85mmL)		

4pc 1/2"DR. Colored 6pt. flank deep impact socket set



4046		12/15.2/16.2/0.75'		1266g
	4pc	17; 19; 21; 22 mm (85mmL)		

9pc 1/2"DR. Colored 6pt. flank deep impact socket set



K4099 6/15.3/16.3/0.8' 2543g
 9pc 14; 15; 17; 19; 21; 22; 23; 24; 27 mm (85mmL)

3pc 1/2"DR. Colored 6pt. flank deep impact socket set



K4033 12/16.8/17.8/0.78' 1435g
 3pc 17; 19; 21 mm (150mmL)

3pc 1/2"DR. Colored 6pt. flank deep impact socket set



4033 20/25.0/26.0/1.1' 1435g
 3pc 17; 19; 21 mm (150mmL)

3pc 1/2"DR. Wheel nut 6pt. flank deep impact socket w/plug



4037 20/18.8/19.8/0.5' 940g
 3pc 17; 19; 21 mm (120mmL)

10pc 1/2"DR. 6pt. Flank impact socket set



4109 20/25.0/26.0/0.6' 1250g
 10pc 11; 12; 13; 14; 16; 17; 19; 21; 22; 24 mm

NEW 4109-18 20/25.0/26.0/0.6' 1250g
 10pc 12; 13; 14; 16; 17; 18; 19; 21; 22; 24 mm

16pc 1/2"DR. 6pt. Flank impact socket set



4166 6/16.7/17.7/1.54' 2776g
 16pc 10; 12; 13; 14; 15; 16; 17; 18; 19; 21; 22; 24; 27; 30; 32; 36 mm

19pc 1/2"DR. 6pt. Flank impact socket set



4193 6/18.8/19.8/0.9' 3130g
 18pc 10; 11; 12; 13; 14; 15; 16; 17; 18; 19; 21; 22; 23; 24; 26; 27; 30; 32 mm
 1pc Ball type 5"(125mm)

10pc 1/2"DR. 6pt. Flank deep impact socket set



4107 10/26.9/27.9/0.7' 2690g
 10pc 11; 12; 13; 14; 16; 17; 19; 21; 22; 24 mm (85mmL)

NEW 4107-18 10/26.9/27.9/0.7' 2690g
 10pc 12; 13; 14; 16; 17; 18; 19; 21; 22; 24 mm (85mmL)

8pc 1/2"DR. Deep impact socket set

NEW



T40813 6/21.0/22.0/0.86' Δ 3500g

8pc 19; 22; 24; 27; 30; 32; 36; 41 mm (85mmL)

T40813-5 6/21.0/22.0/0.86' Δ 3500g

8pc 19; 22; 24; 27; 30; 32; 36; 41 mm (85mmL)

11pc 1/2"DR. 6pt. Flank deep impact socket set



4119 6/24.8/25.8/0.9' Δ 4133g

11pc 12; 14; 17; 19; 21; 22; 23; 24; 27; 30; 32 mm (85mmL)

16pc 1/2"DR. 6pt. Flank deep impact socket set

NEW



4166D 3/16.3/17.3/1.1' Δ 5446

16pc 10; 12; 13; 14; 15; 16; 17; 18; 19; 21; 22; 24; 27; 30; 32; 36 mm (85mmL)

10pc 1/2"DR. 6pt. Flank impact socket set (SAE)



4109S 20/25.0/26.0/0.6' Δ 1250g

10pc 3/8"; 7/16"; 1/2"; 9/16"; 5/8"; 11/16"; 3/4"; 13/16"; 7/8"; 15/16"

10pc 1/2"DR. 6pt. Flank deep impact socket set (SAE)



4107S 10/26.9/27.9/0.7' Δ 2690g

10pc 3/8"; 7/16"; 1/2"; 9/16"; 5/8"; 11/16"; 3/4"; 13/16"; 7/8"; 15/16"

11pc 1/2"DR. Star impact socket set



4117 20/23.7/24.7/0.82' Δ 1185g

10pc E6; E7; E8; E10; E12; E14; E16; E18; E20; E22; E24

11pc 1/2"DR. Star impact socket set

NEW



41112 20/24.4/25.4/0.6' Δ 1220g

11pc E6; E8; E10; E11; E12; E14; E16; E18; E20; E22; E24

7pc 1/2"DR. Hex impact socket bit set (one-piece)



4077 20/16.0/17.0/0.82' Δ 800g
 7pc 4; 5; 6; 8; 10; 12; 14 mm (60mmL)

NEW 4077S 20/16.0/17.0/0.82' Δ 800g
 7pc 3/16"; 1/4"; 5/16"; 3/8"; 7/16"; 1/2"; 9/16" (60mmL)

10pc 1/2"DR. Hex impact socket bit set (one-piece)



41012 20/23.7/24.7/0.82' Δ 1185g
 10pc 4; 5; 6; 7; 8; 10; 12; 14; 17; 19 mm (60mmL)

NEW 41012S 20/23.7/24.7/0.82' Δ 1185g
 10pc 3/16"; 1/4"; 5/16"; 3/8"; 7/16"; 1/2"; 9/16";
 5/8"; 11/16"; 3/4" (60mmL)

7pc 1/2"DR. Star impact socket bit set (one-piece)



4078 20/22.0/23.0/0.82' Δ 1100g
 7pc T30; T40; T45; T50; T55; T60; T70 (60mmL)

10pc 1/2"DR. Star impact socket bit set (one-piece)



41013 20/20.2/21.2/0.82' Δ 1010g
 10pc T20; T25; T27; T30; T40; T45; T50; T55; T60;
 T70 (60mmL)

10pc 1/2"DR. Star impact socket bit set



4108 20/18.0/19.0/0.82' Δ 900g
 10pc T20; T25; T27; T30; T40; T45; T50; T55; T60;
 T70 (55mmL)

7pc 1/2"DR. Spline impact socket bit set (one-piece)

NEW



40713 20/21.0/22.0/0.82' Δ 1050g
 3pc M8; M10; M12 (60mmL)
 4pc M12; M14; M16; M18 (78mmL)

20pc 1/2"DR. Impact socket bit set (one-piece)



4205 6/11.4/12.4/0.9' Δ 1900g
 10pc 4; 5; 6; 7; 8; 10; 12; 14; 17; 19 mm (60mmL)
 10pc T20; T25; T27; T30; T40; T45; T50; T55; T60;
 T70 (60mmL)

26pc 1/2"DR. Impact socket bit set (one-piece)

NEW



4267

6/18.7/19.7/1.65' 3095g

	10pc	4; 5; 6; 7; 8; 10; 12; 14; 17; 19 mm (60mmL)
	10pc	T20; T25; T27; T30; T40; T45; T50; T55; T60; T70 (60mmL)
	3pc	M8; M10; M12 (60mmL)
	3pc	M14; M16; M18 (78mmL)

9pc 1/2"DR. Impact 12pt. deep socket & hex socket bit set



40912

6/22.7/23.7/1.54' 3790g

	6pc	27; 30; 32; 34; 35; 36 mm (85mmL)
	3pc	14; 17; 19 mm (60mmL)

25pc 1/2"DR. Impact star socket & star and spline socket bit set

NEW



4256

6/18.1/19.1/0.9' 3016g

	12pc	E6; E7; E8; E10; E11; E12; E14; E16; E18; E20; E22; E24
	7pc	T30; T40; T45; T50; T55; T60; T70 (60mmL)
	3pc	M8; M10; M12 (60mmL)
	3pc	M14; M16; M18 (78mmL)

7pc 1/2"DR. Colored 6pt. flank deep impact socket & handle set

NEW



40710A

10/27.6/28.6/1.3' 2700g

	4pc	17; 19; 21; 22 mm (85mmL)
	1pc	Adjustable handle (turn-lock design) (8334300)
	1pc	12" (300mm)
	1pc	105" L handle 12.4" (315mm)

7pc Impact adapter (ball type)



K4079

12/23.5/24.5/1.4' 1958g

	7pc	3/8"(F)x1/4"(M); 3/8"(F)x1/2"(M); 1/2"(F)x3/8"(M); 1/2"(F)x3/4"(M); 3/4"(F)x1/2"(M); 3/4"(F)x1"(M); 1"(F)x3/4"(M)
--	-----	--

8pc Impact adapter (pin type)





K4088





12/41.2/42.2/1.4' 3430g

	7pc	3/8"(F)x1/4"(M); 3/8"(F)x1/2"(M); 1/2"(F)x3/8"(M); 1/2"(F)x3/4"(M); 3/4"(F)x1/2"(M); 3/4"(F)x1"(M); 1"(F)x3/4"(M); 1"(F)x1-1/2"(M)
--	-----	---

11pc 1/2"DR. Impact wrench & socket set











4118  6/15.0/16.0/1.1'  2500g

	7pc	10; 11; 12; 13; 14; 16; 17 mm
	1pc	Ratchet impact wrench Max. 100 Nm (82441)
	1pc	Ball type 3"(75mm)
	1pc	Quick connector (20MP)
	1pc	Mini oiler

15pc 1/2"DR. Impact wrench & socket set





4142B  4/20.0/21.0/1.2'  5000g





	10pc	10; 11; 12; 13; 14; 17; 19; 21; 22; 24 mm
	1pc	Impact wrench Max. 1655 Nm (82542)
	1pc	Ball type 5"(125mm)
	1pc	Ball type 1/2"
	1pc	Quick connector (20MP)
	1pc	Mini oiler

11pc 1/2"DR. Impact wrench & socket set

NEW





4118-3  6/15.0/16.0/1.4'  2500g







	7pc	10; 11; 12; 13; 14; 16; 17 mm
	1pc	Ratchet impact wrench Max. 108 Nm (82443)
	1pc	Ball type 3"(75mm)
	1pc	Quick connector (20MP)
	1pc	Mini oiler

15pc 1/2"DR. Impact wrench & socket set

NEW











4142-9  4/19.3/20.3/1.2'  4825g

	10pc	10; 11; 12; 13; 14; 17; 19; 21; 22; 24 mm
	1pc	Impact wrench Max. 1695 Nm (82549)
	1pc	Ball type 5"(125mm)
	1pc	Ball type 1/2"
	1pc	Quick connector (20MP)
	1pc	Mini oiler

15pc 1/2"DR. Impact wrench & socket set





4142  4/20.0/21.0/1.2'  5000g





	10pc	10; 11; 12; 13; 14; 17; 19; 21; 22; 24 mm
	1pc	Impact wrench Max. 1566 Nm (82541)
	1pc	Ball type 5"(125mm)
	1pc	Ball type 1/2"
	1pc	Quick connector (20MP)
	1pc	Mini oiler

18pc 1/2"DR. Impact wrench & socket set

NEW













4189  3/15.0/16.0/1.1'  5018g

	12pc	10; 12; 13; 14; 15; 16; 17; 18; 19; 21; 22; 24 mm (85mmL)
	1pc	Mini impact wrench Max. 1247 Nm (825411)
	1pc	Ball type 1/2"
	2pc	Pin 20L-Ø3.0; 25L-Ø3.0
	2pc	Ring Ø19-Ø3.5; Ø24-Ø3.5

21pc 1/2"DR. Impact wrench & socket set







4215  3/20.4/21.4/1'  6796g

	5pc	10; 13; 17; 19; 24 mm
	3pc	Thin-wall 17; 19; 21 mm (85mmL)
	5pc	15; 17; 19; 21; 23 mm (85mmL)
	1pc	Ratchet impact wrench Max. 108 Nm (82443)
	1pc	Impact wrench Max. 1566 Nm (825410)
	1pc	Bally type 5"(125mm)
	1pc	Bally type 1/2"
	2pc	Pin 20L-Ø3.0; 25L-Ø3.0
	2pc	Ring Ø19-Ø3.5; Ø24-Ø3.5

145pc 1/2"DR. 6pt. Flank impact socket set











41451S  1/27.8/28.8/1.35'  27.8kg

	1pc	Short socket storage L58 x W11 x H45 cm (50141S)
	66pc	Each 11pcs - 10; 11; 12; 13; 14; 16 mm
	20pc	Each 10pcs - 17; 19 mm
	9pc	Each 9pcs - 21 mm
	24pc	Each 8pcs - 22; 23; 24 mm
	14pc	Each 7pcs - 26; 27 mm
	12pc	Each 6pcs - 30; 32 mm

29pc 1/2"DR. Impact wrench & socket set







4293  3/22.3/23.3/1.5'  7433g

	16pc	10; 11; 12; 13; 14; 15; 16; 17; 18; 19; 21; 22; 24; 27; 30; 32 mm
	4pc	10; 13; 16; 18 mm (85mmL)
	3pc	17; 19; 21 mm (85mmL)
	1pc	Impact wrench Max. 1566 Nm (825410)
	1pc	Ball type 5"(125mm)
	2pc	Pin 20L-Ø3.0; 25L-Ø3.0
	2pc	Ring Ø19-Ø3.5; Ø24-Ø3.5

145pc 1/2"DR. 6pt. Flank deep impact socket set





41451D  1/44.8/45.8/1.35'  44.8kg



	1pc	Deep socket storage L58 x W11 x H45 cm (50141D)
	66pc	Each 11pcs - 10; 11; 12; 13; 14; 16 mm (85mmL)
	20pc	Each 10pcs - 17; 19 mm (85mmL)
	9pc	Each 9pcs - 21 mm (85mmL)
	24pc	Each 8pcs - 22; 23; 24 mm (85mmL)
	14pc	Each 7pcs - 26; 27 mm (85mmL)
	12pc	Each 6pcs - 30; 32 mm (85mmL)

133pc 1/2"DR. 6pt. Flank impact socket set (SAE)

NEW



41331S  1/25.4/26.4/1.35'  25kg

	1pc	Short socket storage L58 x W11 x H45 cm (50141SS)
	70pc	Each 10pcs - 5/16"; 3/8"; 7/16"; 1/2"; 9/16"; 5/8"; 11/16"
	18pc	Each 9pcs - 3/4"; 13/16"
	8pc	Each 8pcs - 7/8"
	14pc	Each 7pcs - 15/16"; 1"
	18pc	Each 6pcs - 1-1/16"; 1-1/8"; 1-3/16"
	5pc	Each 5pcs - 1-1/4"



133pc 1/2"DR. 6pt. Flank deep impact socket set (SAE)

NEW



41331D

1/37.3/39.3/1.35' Δ 37kg



	1pc	Deep socket storage L58 x W11 x H45 cm (50141DS)
	70pc	Each 10pcs - 5/16"; 3/8"; 7/16"; 1/2"; 9/16"; 5/8"; 11/16" (85mmL)
	18pc	Each 9pcs - 3/4"; 13/16" (85mmL)
	8pc	Each 8pcs - 7/8" (85mmL)
	14pc	Each 7pcs - 15/16"; 1" (85mmL)
	18pc	Each 6pcs - 1-1/16"; 1-1/8"; 1-3/16" (85mmL)
	5pc	Each 5pcs - 1-1/4" (85mmL)

3-Layer socket display shelf with 275pc impact sockets



50121E-275

1/62.4/63.4/3.34' Δ 62kg



	1pc	Socket display shelf with size sticker L42 x W35 x H48 cm (50121E)
	110pc	Each 10pcs - 10; 12; 13; 14; 15; 16; 17; 18; 19; 21; 22mm
	9pc	Each 9pcs - 24 mm
	8pc	Each 8pcs - 27 mm
	14pc	Each 7pcs - 30; 32 mm
	6pc	Each 6pcs - 36 mm
	5pc	Each 5pcs - 41 mm
	60pc	Each 10pcs - 10; 12; 13; 14; 15; 16 mm (85mmL)
	24pc	Each 8pcs - 17; 18; 19 mm (85mmL)
	14pc	Each 7pcs - 21; 22 mm (85mmL)
	6pc	Each 6pcs - 24 mm (85mmL)
	15pc	Each 5pcs - 27; 30; 32 mm (85mmL)
	4pc	Each 4pcs - 36 mm (85mmL)

3-Layer socket display shelf with 271pc impact sockets (SAE)







50121F-271

1/60.8/61.8/3.34' Δ 60kg

	1pc	Socket display shelf with size sticker L42 x W35 x H48 cm (50121F)
	100pc	Each 10pcs - 5/16"; 3/8"; 7/16"; 1/2"; 9/16"; 5/8"; 11/16"; 3/4"; 13/16"; 7/8"
	18pc	Each 9pcs - 15/16"; 1"
	7pc	Each 7pcs - 1-1/16"
	24pc	Each 6pcs - 1-1/8"; 1-3/16"; 1-1/4"; 1-5/16"
	60pc	Each 10pcs - 5/16"; 3/8"; 7/16"; 1/2"; 9/16"; 5/8" (85mmL)
	16pc	Each 8pcs - 11/16"; 3/4" (85mmL)
	14pc	Each 7pcs - 13/16"; 7/8" (85mmL)
	12pc	Each 6pcs - 15/16"; 1" (85mmL)
	20pc	Each 5pcs - 1-1/16"; 1-1/8"; 1-3/16"; 1-1/4" (85mmL)





1/2"DR. Phillips impact socket bit



241				
Part no.	size	mm	g	pc/box
241552	PH.2	55	104	10
241553	PH.3	55	104	10
241554	PH.4	55	104	10





1/2"DR. Slotted impact socket bit



243				
Part no.	size	mm	g	pc/box
2435508	1.2x8	55	102	10
2435510	1.6x10	55	104	10
2435512	2.0x12	55	104	10
2435514	2.5x14	55	106	10
2435516	2.5x16	55	108	10





1/2"DR. Phillips impact socket bit(one piece)



241060				
Part no.	size	mm	g	pc/box
2410601	PH.1	60	69	10
2410602	PH.2	60	71	10
2410603	PH.3	60	74	10





1/2"DR. Hex impact socket bit



244				
Part no.	size	mm	g	pc/box
24405503	3	55	104	10
24405504	4	55	104	10
24405505	5	55	106	10
24405506	6	55	106	10
24405507	7	55	106	10
24405508	8	55	112	10
24405509	9	55	113	10
24405510	10	55	114	10
24405512	12	55	122	10
24406514	14	65	186	10
24407016 NEW	16	65	200	10
24407017	17	70	232	10
24407019	19	70	272	10
24410005	5	100	136	10
24410006	6	100	136	10
24410007	7	100	136	10
24410008	8	100	138	10

1/2"DR. Pozidriv impact socket bit



242				
Part no.	size	mm	g	pc/box
242552	PZ.2	55	104	10
242553	PZ.3	55	104	10
242554	PZ.4	55	104	10

1/2"DR. Hex impact socket bit (one-piece)



244060		<i>l</i>		
Part no.	size	mm	g	pc/box
24406004	4	60	70	10
24406005	5	60	70	10
24406006	6	60	74	10
24406007	7	60	74	10
24406008	8	60	76	10
24406010	10	60	94	10
24406012	12	60	103	10
24406014	14	60	115	10
24406016	16	60	148	10
24406017	17	60	150	10
24406019	19	60	154	10
24406021	21	60	192	10
24406022	22	60	165	10
24406024	24	60	175	10
2440603.16	3/16"	60	66	10
2440601.4	1/4"	60	72	10
2440605.16	5/16"	60	78	10
2440603.8	3/8"	60	85	10
2440607.16	7/16"	60	95	10
2440601.2	1/2"	60	102	10
2440609.16	9/16"	60	111	10
2440605.8	5/8"	60	146	10
24406011.16	11/16"	60	159	10
2440603.4	3/4"	60	154	10
24406013.16	13/16"	60	192	10
244078		<i>l</i>		
Part no.	size	mm	g	pc/box
24407804	4	78	72	10
24407805	5	78	75	10
24407806	6	78	81	10
24407807	7	78	84	10
24407808	8	78	87	10
24407810	10	78	109	10
24407812	12	78	124	10
24407813	13	78	132	10
24407814	14	78	140	10
24407817	17	78	180	10
24407819	19	78	204	10
24407822	22	78	280	10
24407824	24	78	320	10

1/2"DR. Star impact socket bit (one-piece)



246		<i>l</i>		
Part no.	size	mm	g	pc/box
24620	T20	40	61	10
24625	T25	40	61	10
24627	T27	40	61	10
24630	T30	40	61	10
24640	T40	40	62	10
24645	T45	40	62	10
24650	T50	40	64	10
24655	T55	40	69	10
24660	T60	40	74	10
24670	T70	40	86	10

1/2"DR. Star impact socket bit



246		<i>l</i>		
Part no.	size	mm	g	pc/box
24605520	T20	55	106	10
24605525	T25	55	106	10
24605527	T27	55	106	10
24605530	T30	55	108	10
24605540	T40	55	108	10
24605545	T45	55	108	10
24605550	T50	55	112	10
24605555	T55	55	122	10
24605560	T60	55	124	10
24605570	T70	55	142	10
24610040	T40	100	138	10
24610045	T45	100	140	10
24610050	T50	100	142	10
24610055	T55	100	160	10
24610060	T60	100	162	10

1/2"DR. Star impact socket bit (one-piece)



246060		<i>l</i>		
Part no.	size	mm	g	pc/box
24606010	T10	60	62	10
24606015	T15	60	62	10
24606020	T20	60	63	10
24606025	T25	60	63	10
24606027	T27	60	63	10
24606030	T30	60	63	10
24606035 <small>NEW</small>	T35	60	66	10
24606040	T40	60	67	10
24606045	T45	60	71	10
24606050	T50	60	74	10
24606055	T55	60	88	10
24606060	T60	60	99	10
24606070	T70	60	108	10

1/2"DR. Spline impact socket bit



248		<i>l</i>		
Part no.	size	mm	g	pc/box
24805505	M5	55	104	10
24805506	M6	55	104	10
24805508	M8	55	104	10
24805509	M9	55	104	10
24805510	M10	55	106	10
24805512	M12	55	114	10
24810005	M5	100	146	10
24810006	M6	100	148	10
24810008	M8	100	148	10
24810010	M10	100	150	10
24810012	M12	100	158	10

1/2"DR. Spline impact socket bit (one-piece)



248060		<i>l</i>		
Part no.	size	mm	g	pc/box
24806008	M8	60	74	10
24806010	M10	60	85	10
24806012	M12	60	93	10
248078		<i>l</i>		
Part no.	size	mm	g	pc/box
24807812	M12	78	107	10
24807814	M14	78	110	10
24807816	M16	78	115	10
24807818	M18	78	118	10

1/2"DR. Square impact socket



44114		<i>l</i>		
Part no.	size	mm	g	pc/box
44114	14	30	96	10

1/2"DR. 6pt. Flank impact socket



445		<i>l</i>		
Part no.	size	mm	g	pc/box
44508	8	38	71	10
44509	9	38	71	10
44510	10	38	72	10
44511	11	38	72	10
44512	12	38	74	10
44513	13	38	77	10
44514	14	38	80	10
44515	15	38	82	10
44516	16	38	85	10
44517	17	38	89	10
44518	18	38	89	10
44519	19	38	102	10
44520	20	38	124	10
44521	21	38	124	10
44522	22	40	148	10
44523	23	43	148	10
44524	24	43	154	10
44525	25	45	160	10
44526	26	45	181	10
44527	27	45	181	10
44528	28	48	197	10
44529	29	48	200	10
44530	30	48	218	10
44531	31	48	218	10
44532	32	48	218	10
44533	33	50	223	10
44534	34	50	230	10
44535	35	52	268	10
44536	36	52	289	10
44538	38	54	314	10
44539	39	54	350	10
44541	41	57	388	10
44545 ^{NEW}	45	57	540	10
44546	46	57	572	10
4455.16	5/16"	38	70	10
4453.8	3/8"	38	72	10
4457.16	7/16"	38	74	10
4451.2	1/2"	38	77	10
4459.16	9/16"	38	77	10
4455.8	5/8"	38	85	10
44511.16	11/16"	38	104	10
4453.4	3/4"	38	120	10
44513.16	13/16"	38	130	10
4457.8	7/8"	40	147	10
44515.16	15/16"	45	153	10
4451.0	1"	45	169	10
4451.1.16	1-1/16"	45	173	10
4451.1.8	1-1/8"	48	193	10
4451.3.16	1-3/16"	48	201	10
4451.1.4	1-1/4"	48	210	10
4451.5.16	1-5/16"	50	285	10
4451.3.8	1-3/8"	50	311	10
4451.7.16	1-7/16"	50	354	10
4451.1.2	1-1/2"	50	373	10

1/2"DR. 6pt. Flank middle deep impact socket



44552		<i>l</i>		
Part no.	size	mm	g	pc/box
4455214	14	52	100	10
4455215 ^{NEW}	15	52	103	10
4455216 ^{NEW}	16	52	111	10
4455217	17	52	125	10
4455218 ^{NEW}	18	52	114	10
4455219	19	52	142	10
4455221	21	52	161	10
4455223	23	52	174	10
4455224	24	52	185	10

1/2"DR. Thin-wall 6pt. flank middle deep impact socket



44552...TH			<i>l</i>		
Part no.	size	mm	mm	g	pc/box
4455214TH	14	20	52	86	10
4455217TH	17	25	52	99	10
4455219TH	19	27	52	118	10
4455221TH	21	28	52	130	10
4455223TH	23	31	52	144	10
4455224TH	24	32	52	152	10

1/2"DR. 6pt. Flank deep impact socket



44585		<i>l</i>		
Part no.	size	mm	g	pc/box
4458506 ^{NEW}	6	85	93	10
4458508	8	85	110	10
4458509	9	85	120	10
4458510	10	85	123	10
4458506 ^{NEW}	6	85	93	10
4458508	8	85	110	10
4458509	9	85	120	10
4458510	10	85	123	10
4458511	11	85	135	10
4458512	12	85	147	10
4458513	13	85	154	10
4458514	14	85	178	10
4458515	15	85	181	10
4458516	16	85	204	10
4458517	17	85	209	10
4458518	18	85	215	10
4458519	19	85	242	10
4458520	20	85	277	10
4458521	21	85	279	10
4458522	22	85	299	10
4458523	23	85	299	10
4458524	24	85	336	10
4458525	25	85	366	10
4458526	26	85	367	10
4458527	27	85	367	10
4458528	28	85	377	10
4458529	29	85	393	10
4458530	30	85	400	10
4458531	31	85	405	10
4458532	32	85	458	10
4458533	33	85	466	10
4458534	34	85	475	10
4458535	35	85	489	10
4458536	36	85	499	10
4458537 ^{NEW}	37	85	603	5
4458538	38	85	518	5
4458539 ^{NEW}	39	85	679	5
4458540 ^{NEW}	40	85	682	5
4458541	41	85	545	5

44585		<i>l</i>		
Part no.	size	mm	g	pc/box
445855.16	5/16"	85	110	10
445853.8	3/8"	85	127	10
445857.16	7/16"	85	133	10
445851.2	1/2"	85	157	10
445859.16	9/16"	85	171	10
445855.8	5/8"	85	201	10
4458511.16	11/16"	85	211	10
445853.4	3/4"	85	232	10
4458513.16	13/16"	85	274	10
445857.8	7/8"	85	305	10
4458515.16	15/16"	85	341	10
445851.0	1"	85	350	10
445851.1.16	1-1/16"	85	360	10
445851.1.8	1-1/8"	85	372	10
445851.3.16	1-3/16"	85	393	10
445851.1.4	1-1/4"	85	418	10
445851.5.16	1-5/16"	85	504	10
445851.3.8	1-3/8"	85	522	10
445851.7.16	1-7/16"	85	625	5
445851.1.2	1-1/2"	85	623	5

1/2"DR. 6pt. Thin-wall flank deep impact socket



44585...TH			<i>l</i>		
Part no.	size	mm	mm	g	pc/box
4458517TH	17	25	85	173	10
4458519TH	19	27	85	219	10
4458521TH	21	28	85	240	10
4458522TH ^{NEW}	22	30	85	245	10

1/2"DR. Colored 6pt. flank deep impact socket



44585...C		l			
Part no.	size	mm	g	color	pc/box
4458514C	14	85	175	Black	1
4458515C	15	85	180	Gold	1
4458517C	17	85	225	Blue	1
4458519C	19	85	240	Yellow	1
4458521C	21	85	260	Red	1
4458522C	22	85	305	Green	1
4458523C	23	85	310	Purple	1
4458524C	24	85	312	Dark Green	1
4458527C	27	85	362	Brown	1

1/2"DR. Wheel nut 6pt. Flank deep impact socket w/plug



445120		l		
Part no.	Size	mm	g	pc/box
44512017	17	120	264	10
44512019	19	120	306	10
44512021	21	120	348	10

1/2"DR. 12pt. Flank impact socket



448		l		
Part no.	Socket	mm	g	pc/box
44808	8	38	74	10
44809 NEW	9	38	67	10
44810	10	38	74	10
44811	11	38	74	10
44812	12	38	74	10
44813	13	38	76	10
44814	14	38	76	10
44815	15	38	81	10
44816	16	38	84	10
44817	17	38	86	10
44818	18	38	86	10
44819	19	38	102	10
44820	20	38	117	10
44821	21	38	120	10
44822	22	40	147	10
44823	23	43	147	10
44824	24	43	148	10
44826	26	45	168	10
44827	27	45	168	10
44828	28	48	185	10
44830	30	48	204	10
44832	32	48	206	10
44836 NEW	36	52	309	10

1/2"DR. 12pt. Flank deep impact socket



44885		l		
Part no.	Socket	mm	g	pc/box
4488508 NEW	8	85	109	10
4488510	10	85	123	10
4488511 NEW	11	85	133	10
4488512	12	85	144	10
4488513 NEW	13	85	153	10
4488514	14	85	174	10
4488515 NEW	15	85	174	10
4488516	16	85	204	10
4488517	17	85	222	10
4488518 NEW	18	85	223	10
4488519	19	85	244	10
4488520 NEW	20	85	217	10
4488521	21	85	261	10
4488522	22	85	319	10
4488523 NEW	23	85	329	10
4488524	24	85	329	10
4488525 NEW	25	85	348	10
4488526 NEW	26	85	352	10
4488527	27	85	377	10
4488528 NEW	28	85	387	10
4488529 NEW	29	85	432	10
4488530	30	85	411	10
4488532	32	85	443	10
4488533	33	85	466	10
4488534	34	85	507	10
4488535	35	85	485	10
4488536	36	85	479	10
4488538 NEW	38	85	590	10
4488541 NEW	41	85	651	5

1/2"DR. Colored 6pt. flank deep impact socket



445150...C		l			
Part no.	size	mm	g	color	pc/box
44515017C	17	150	365	Blue	1
44515019C	19	150	395	Yellow	1
44515021C	21	150	420	Red	1

1/2"DR. Star impact socket



446		l		
Part no.	Socket	mm	g	pc/box
44606	E6	38	62	10
44607	E7	38	62	10
44608	E8	38	62	10
44610	E10	38	74	10
44611	E11	38	74	10
44612	E12	38	77	10
44614	E14	38	77	10
44616	E16	38	77	10
44618	E18	38	124	10
44620	E20	38	126	10
44622	E22	38	132	10
44624	E24	42	155	10

1/2"DR. Impact extension (pin type)



8044...MPP	l	g	pc/box
Part no.	mm	g	pc/box
8044075MPP	75-3"	148	10
8044125MPP	125-5"	230	10

1/2"DR. Impact universal joint (pin type)



80541MPP	l	g	pc/box
Part no.	mm	g	pc/box
80541MPP	75	141	10

1/2"DR. Impact adaptor (ball type)



8094...MPB	Size	l	g	pc/box
Part no.	mm	mm	g	pc/box
80943MPB	1/2"(F)x3/8"(M)	38	72	10
80946MPB	1/2"(F)x3/4"(M)	48	145	10

O-ring & Pin for 1/2"DR.



Part no.	O	—	g
Part no.	mm	mm	g
R1935	Ø19- Ø3.5		2
P2030		20L- Ø3.0	2
R2435	Ø24- Ø3.5		2
P2530		25L- Ø3.0	2

1/2"DR. Impact extension (ball type)



8044...MPB	l	g	pc/box
Part no.	mm	g	pc/box
8044050MPB	50-2"	105	10
8044075MPB	75-3"	170	10
8044125MPB	125-5"	230	10
8044250MPB	250-10"	420	5

1/2"DR. Impact universal joint (ball type)



80541MPB	l	g	pc/box
Part no.	mm	g	pc/box
80541MPB	75	139	10

1/2"DR. Impact bit holder



8104...MPB	Size	l	g	pc/box
Part no.	mm	mm	g	pc/box
81042MPB	1/2"(F)x1/4"(F)	50	76	10
81045MPB	1/2"(F)x5/16"(F)	50	89	10

Part mapping for 1/2"DR.

Tool No.	O-ring	Pin
24155 2...4	R1935	P2030
24106 01...03	R1935	P2030
24255 2...4	R1935	P2030
24355 08...12	R1935	P2030
24355 14...16	R2435	P2530
244055 03...12	R1935	P2030
244065 14...16	R2435	P2530
244070 17...19	R2435	P2530
244100 05...08	R1935	P2030
244060 04...14	R1935	P2030
244060 16...24	R2435	P2530
244078 04...14	R1935	P2030
244078 17...24	R2435	P2530
244060 3.16...9.16	R1935	P2030
244060 5.8...13.16	R2435	P2530
246 20...70	R1935	P2030
246055 20...60	R1935	P2030
24605570	R2435	P2530
246100 40...60	R1935	P2030
246060 10...60	R1935	P2030
24606070	R2435	P2530
248055 05...12	R1935	P2030
248100 05...12	R1935	P2030
248060 08...12	R1935	P2030
248078 12...14	R1935	P2030
248078 16...18	R2435	P2530
44114	R1935	P2030
445 08...18	R1935	P2030
445 19...41	R2435	P2530
445 45...46	R3755	P3540
445 5.16...11.16	R1935	P2030
445 3.4...1.1.2	R2435	P2530

1/2"DR. Impact adaptor (pin type)



8094...MPP	Size	l	g	pc/box
Part no.	mm	mm	g	pc/box
80943MPP	1/2"(F)x3/8"(M)	38	70	10
80946MPP	1/2"(F)x3/4"(M)	48	140	10

1/2"DR. Ratchet impact wrench



82441	l		
Part no.	mm	g	pc/box
82441	230-9.7"	1200	1

Specifications :

Length:Square Drive1/2"
 Free Speed (R.P.M.)160
 Max Torque (ft/lbs) / (Nm)74 / 100
 Air Pressure (PSI)90
 Air Inlet(P.T.)1/4"
 Air Consumption (C.F.M.)7

- Rear exhaust

1/2"DR. Recoilless ratchet impact wrench

NEW



82445	l		
Part no.	mm	g	pc/box
82445	327-12.9"	1830	1

Specifications :

Length:Square Drive1/2"
 Free Speed (R.P.M.)200
 Max Torque (ft/lbs) / (Nm)89 / 120
 Air Pressure (PSI)90
 Air Inlet(P.T.)1/4"
 Air Consumption (C.F.M.)8.8

1/2"DR. Ultra-duty ratchet impact wrench

NEW



82443	l		
Part no.	mm	g	pc/box
82433	260-10.3"	1180	1

Specifications :

Square Drive1/2"
 Free Speed (R.P.M.)200
 Working Torque Range (ft/lbs) / (Nm)5-70 / 7-95
 Max Torque (ft/lbs) / (Nm)80 / 108
 Air Pressure (PSI)90
 Air Inlet(P.T.)1/4"
 Air Consumption (C.F.M.)3.25

Special Features:

Low vibration and noise: high efficiency with 360-degree adjustable exhaust (black ring) directing air away from operator and the work.

1/2"DR. Impact wrench



82541	l		
Part no.	mm	g	pc/box
82541	180-7.1"	2560	1

Specifications :

Length:Square Drive1/2"
 Free Speed (R.P.M.)8000
 Max Torque (ft/lbs) / (Nm)1155 / 1566
 Air Pressure (PSI)90
 Air Inlet(P.T.)1/4"
 Air Consumption (C.F.M.)4.2

- Front exhaust

1/2"DR. Impact wrench

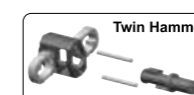

82542	l		
Part no.	mm	g	pc/box
82542	186-7.3"	2560	1

Specifications :

Length:Square Drive1/2"
 Free Speed (R.P.M.)8000
 Max Torque (ft/lbs) / (Nm)1221 / 1655
 Air Pressure (PSI)90
 Air Inlet(P.T.)1/4"
 Air Consumption (C.F.M.)4.2

- Handle exhaust with muffler

1/2"DR. Mini composite impact wrench

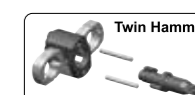

82544	l		
Part no.	mm	g	pc/box
82544	154mm-6" 154-3"1200	1200	1

Specifications :

Length:Square Drive 1/2"
 Free Speed (R.P.M.) 12500
 Working Torque Range (ft/lbs) / (Nm) 90-260 / 120-351
 Max Torque (ft/lbs) / (Nm) 550 / 745
 Air Pressure (PSI) 90
 Air Inlet(P.T.) 1/4"
 Air Consumption (C.F.M.) 4

1/2"DR. Mini impact wrench

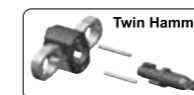

82543	l		
Part no.	mm	g	pc/box
82543	145-5.7"	1500	1

Specifications :

Length:Square Drive1/2"
 Free Speed (R.P.M.) 12500
 Working Torque Range (ft/lbs) / (Nm)90-280 / 120-378
 Max Torque (ft/lbs) / (Nm)550 / 745
 Air Pressure (PSI)90
 Air Inlet(P.T.)1/4"
 Air Consumption (C.F.M.)4

1/2"DR. Heavy duty composite impact wrench



82549	l		
Part no.	mm	g	pc/box
82549	171-6.7"	1950	1

Specifications :

Length:Square Drive1/2"
 Free Speed (R.P.M.)8000
 Working Torque Range (ft/lbs) / (Nm)50-600 / 68-810
 Max Torque (ft/lbs) / (Nm)1250 / 1695
 Air Pressure (PSI)90
 Air Inlet(P.T.)1/4"
 Air Consumption (C.F.M.)4

- Switch can be changed for right or left handed.

1/2"DR. Impact wrench



825410	l		
Part no.	mm	g	pc/box
825410	185-7.3"	2630	1

Specifications :
 Square Drive 1/2"
 Free Speed (R.P.M.) 8500
 Working Torque Range (ft/lbs) / (Nm) 25-400 / 34-544
 Max Torque (ft/lbs) / (Nm) 1155 / 1566
 Air Pressure (PSI) 90
 Air Inlet(P.T.) 1/4"
 Noise Level (dBA) 102

1/2"DR. Super duty mini impact wrench



825411	l		
Part no.	mm	g	pc/box
825411	109-4.3"	1300	1

Specifications :
 Square Drive 1/2"
 Free Speed (R.P.M.) 9000
 Working Torque Range (ft/lbs) / (Nm) 102-310 / 138-420
 Max Torque (ft/lbs) / (Nm) 920 / 1247
 Air Pressure (PSI) 90
 Air Inlet(P.T.) 1/4"
 Air consumption (C.F.M.) 4.76
 • Switch can be changed for right or left handed.

5" Angle grinder with lever throttle



82601	l		
Part no.	mm	g	pc/box
82601	235-9.3"	1800	1

Specifications :
 Spindle Thread Size M10x1.5
 Free Speed (R.P.M.) 11000
 Air Pressure (PSI) 90
 AIR Inlet (P.T.) 1/4"
 Air Consumption (C.F.M.) 5

6mm Industrial grader air die grinder



82602	l		
Part no.	mm	g	pc/box
82602	145-5.7"	600	1

Specifications :
 Collect Size 3mm; 6mm; 1/8"; 1/4"
 Free Speed (R.P.M.) 22000
 Air Pressure (PSI) 90
 AIR Inlet (P.T.) 1/4"
 Air Consumption (C.F.M.) 3

7pc 3/4"DR. 6pt. Flank impact socket set



6071			4/24.0/25.0/1.1'		6000g
7pc	30; 32; 36; 41; 46; 50; 55 mm				

8pc 3/4"DR. 6pt. Flank impact socket set



6081			6/21.0/22.0/0.89'		3500g
8pc	26; 27; 29; 30; 32; 35; 36; 38 mm				

8pc 3/4"DR. 6pt. Flank impact socket set

NEW



6083			6/20.1/21.1/1.2'		3347g
8pc	19; 22; 24; 27; 30; 32; 36; 41 mm				

11pc 3/4"DR. 6pt. Flank impact socket set



6112			3/18.6/19.6/1.5'		6200g
11pc	17; 19; 22; 24; 27; 30; 32; 36; 41; 46; 50 mm				

12pc 3/4"DR. 6pt. Flank impact socket set

NEW



T6121

6/26.0/27.0/0.66' Δ 4338g

	12pc	17; 19; 21; 22; 24; 27; 30; 32; 34; 36; 38; 41 mm
--	------	---

16pc 3/4"DR. 6pt. Flank impact socket set

NEW



6163

2/15.7/16.7/0.54' Δ 7605g

	16pc	19; 21; 22; 24; 26; 27; 28; 29; 30; 32; 33; 34; 36; 38; 41; 46 mm
--	------	---

8pc 3/4"DR. 6pt. Flank deep impact socket set



6081D

2/13.4/14.4/0.6' Δ 6700g

	8pc	26; 27; 29; 30; 32; 35; 36; 38 mm (100mmL)
--	-----	--

8pc 3/4"DR. Deep impact socket set



6082D

2/13.4/14.4/0.6' Δ 6700g

	2pc	19; 21 mm (90mmL)
	6pc	27; 30; 32; 35; 38; 41 mm (100mmL)

8pc 3/4"DR. 6pt. Flank deep impact socket set

NEW



6083D

2/12.3/13.3/0.54' Δ 6144g

	8pc	19; 22; 24; 27; 30; 32; 36; 41 mm (100mmL)
--	-----	--

8pc 3/4"DR. 6pt. Flank deep impact socket set

NEW



T6085

6/30.4/31.4/0.66' Δ 5064g

	8pc	19; 22; 24; 27; 30; 32; 36; 41 mm (100mmL)
--	-----	--

9pc 3/4"DR. 6pt. Flank deep impact socket set

NEW



6092D

3/23.1/24.1/1.1' Δ 7708g

	9pc	24; 27; 30; 32; 33; 36; 38; 41; 46 mm (100mmL)
--	-----	--

11pc 3/4"DR. 6pt. Flank deep impact socket set

NEW



6115D

3/21.2/22.2/1.1' Δ 7054g

	11pc	17; 19; 21; 22; 24; 27; 30; 32; 33; 36; 38 mm (100mmL)
--	------	--

8pc 3/4"DR. 6pt. Flank impact socket set (SAE)

6081S

6/21.0/22.0/0.89' Δ 3500g

	8pc	1"; 1-1/16"; 1-1/8"; 1-1/4"; 1-5/16"; 1-3/8"; 1-7/16"; 1-1/2"
--	-----	---



16pc 3/4"DR. 6pt. Flank impact socket set (SAE)

NEW



6163S		2/18.1/19.1/0.54'		9050g
	16pc	3/4"; 7/8"; 15/16"; 1"; 1-1/16"; 1-1/8"; 1-3/16"; 1-1/4"; 1-5/16"; 1-3/8"; 1-7/16"; 1-1/2"; 1-5/8"; 1-3/4"; 1-13/16"; 1-7/8"		

8pc 3/4"DR. 6pt. Flank deep impact socket set (SAE)



6081DS		2/13.4/14.4/0.6'		6700g
	8pc	1"; 1-1/16"; 1-1/8"; 1-1/4"; 1-5/16"; 1-3/8"; 1-7/16"; 1-1/2" (100mmL)		

8pc 3/4"DR. Deep impact socket set (SAE)



6082DS		2/13.4/14.4/0.6'		6700g
	2pc	3/4"; 13/16" (90mmL)		
	6pc	1-1/16"; 1-1/8"; 1-3/16"; 1-1/4"; 1-3/8"; 1-1/2" (100mmL)		

11pc 3/4"DR. Truck wheel deep impact socket set (S&M)



6113		3/27.5/28.5/1.5'		9150g
	2pc	17; 21 mm (90mmL)		
	1pc	13/16" (90mmL)		
	4pc	33; 35; 38; 41 mm (100mmL)		
	4pc	1-1/16"; 1-1/8"; 1-1/4"; 1-1/2" (100mmL)		

9pc 3/4"DR. Hex impact socket bit set (one-piece)

NEW



6091		4/22.4/23.4/0.72'		5578g
	9pc	14; 16; 17; 19; 22; 24; 27; 30; 32 mm (90mmL)		
6091S		4/22.4/23.4/0.72'		5578g
	9pc	9/16"; 5/8"; 11/16"; 3/4"; 7/8"; 15/16"; 1-1/16"; 1-3/16"; 1-1/4" (90mmL)		

10pc 3/4"DR. Impact wrench & socket set



6111		2/17.6/18.6/1.4'		8800g
	8pc	22; 24; 27; 30; 32; 36; 38; 41 mm		
	1pc	Impact wrench Max. 1673 Nm (82563)		
	1pc	Mini oiler		

10pc 3/4"DR. Impact wrench & socket set

NEW



6111-6		2/18.5/19.5/1.4'		9240g
	8pc	22; 24; 27; 30; 32; 36; 38; 41 mm		
	1pc	Impact wrench Max. 1912 Nm (82566)		
	1pc	Mini oiler		

10pc 3/4"DR. Impact wrench & socket set



6111D 2/22.0/23.0/1.4' 11kg

	8pc	22; 24; 27; 30; 32; 36; 38; 41 mm (100mmL)
	1pc	Impact wrench Max. 1673 Nm (82563)
	1pc	Mini oiler

10pc 3/4"DR. Impact wrench & socket set



6111D-6 2/22.7/23.7/1.4' 11.3kg

	8pc	22; 24; 27; 30; 32; 36; 38; 41 mm (100mmL)
	1pc	Impact wrench Max. 1912 Nm (82566)
	1pc	Mini oiler

14pc 3/4"DR. Impact wrench & socket set



6142-6 3/27.6/28.6/1.5' 9200g

	5pc	24; 27; 30; 32; 33 mm
	1pc	Impact wrench Max. 1912 Nm (82566)
	1pc	Pin type 7"(175mm)
	1pc	Pin type 3/4"
	3pc	Pin 30L-Ø4.0; 35L-Ø4.0; 45L-Ø4.0
	3pc	Ring Ø33-Ø5.5; Ø37-Ø5.5; Ø44-Ø5.5

3/4"DR. Hex impact socket bit (one-piece)



26490

Part no.	Socket	mm	g	pc/box
2649014	14	90	420	2
2649016 NEW	16	90	420	2
2649017	17	90	455	2
2649019	19	90	496	2
2649022	22	90	520	2
2649024	24	90	561	2
2649027	27	90	650	2
2649030	30	90	670	2
2649032	32	90	740	2
264909.16 NEW	9/16"	90	403	2
264905.8 NEW	5/8"	90	423	2
2649011.16 NEW	11/16"	90	439	2
264903.4 NEW	3/4"	90	458	2
264907.8 NEW	7/8"	90	515	2
2649015.16 NEW	15/16"	90	547	2
264901.1.16 NEW	1-1/16"	90	606	2
264901.3.16 NEW	1-3/16"	90	684	2
264901.1.4 NEW	1-1/4"	90	725	2

3/4"DR. Square deep impact socket



46190

Part no.	Socket	mm	g	pc/box
4619017	17	90	520	1
4619019	19	90	520	1
4619020	20	90	520	1
4619021	21	90	520	1
4619022 NEW	22	90	652	1
4619011.16	11/16"	90	520	1
461903.4	3/4"	90	520	1
4619013.16	13/16"	90	520	1

3/4"DR. Square impact socket



461

Part no.	Socket	mm	g	pc/box
46117	17	50	398	1
46119	19	50	400	1
46120	20	50	378	1
46121	21	50	412	1
46111.16	11/16"	50	398	1
4613.4	3/4"	50	400	1
46113.16	13/16"	50	412	1

3/4"DR. 6pt. Flank impact socket



465		l		
Part no.	Socket	mm	g	pc/box
46517	17	50	254	2
46518	18	50	252	2
46519	19	50	248	2
46520	20	50	254	2
46521	21	50	254	2
46522	22	50	262	2
46523	23	50	266	2
46524	24	50	268	2
46525	25	50	268	2
46526	26	50	268	2
46527	27	54	294	2
46528	28	54	364	2
46529	29	54	362	2
46530	30	54	376	2
46531	31	54	384	2
46532	32	57	380	2
46533	33	57	412	1
46534	34	57	434	1
46535	35	57	438	1
46536	36	57	432	1
46537	37	57	444	1
46538	38	57	452	1
46539	39	57	478	1
46540	40	57	480	1
46541	41	57	498	1
46542	42	57	564	1
46543	43	63	580	1
46544	44	63	626	1
46545	45	63	658	1
46546	46	63	772	1
46547	47	68	1016	1
46548	48	68	1015	1
46549 NEW	49	68	1023	1
46550	50	68	1078	1
46551 NEW	51	70	1130	1
46552	52	70	1127	1
46553 NEW	53	70	1142	1
46554	54	70	1215	1
46555	55	72	1258	1
46556 NEW	56	72	1286	1
46557	57	72	1333	1
46558	58	75	1401	1

465		l		
Part no.	Socket	mm	g	pc/box
46559	59	75	1489	1
46560	60	75	1282	1
46563	63	78	1500	1
46565	65	78	1548	1
46570	70	85	2038	1
4653.4	3/4"	50	244	2
46511.16	11/16"	50	272	2
46513.16	13/16"	50	258	2
4657.8	7/8"	50	260	2
46515.16	15/16"	50	264	2
4651.0	1"	50	264	2
4651.1.16	1-1/16"	54	300	2
4651.1.8	1-1/8"	54	366	2
4651.3.16	1-3/16"	54	366	2
4651.1.4	1-1/4"	57	390	2
4651.5.16	1-5/16"	57	418	1
4651.3.8	1-3/8"	57	442	1
4651.7.16	1-7/16"	57	464	1
4651.1.2	1-1/2"	57	452	1
4651.9.16	1-9/16"	57	524	1
4651.5.8	1-5/8"	57	524	1
4651.11.16	1-11/16"	63	582	1
4651.3.4	11-3/4"	63	686	1
4651.13.16	1-13/16"	63	748	1
4651.7.8	1-7/8"	68	850	1
4651.15.16	1-15/16"	68	910	1
4652.0	2"	68	998	1
4652.1.16	2-1/16"	70	990	1
4652.1.8	2-1/8"	70	1022	1
4652.3.16	2-3/16"	72	1062	1
4652.1.4	2-1/4"	72	1176	1
4652.5.16	2-5/16"	75	1190	1
4652.3.8	2-3/8"	75	1282	1
4652.1.2	2-1/2"	78	1560	1
4652.5.8	2-5/8"	80	1715	1
4652.3.4	2-3/4"	85	2096	1

3/4"DR. 6pt. Flank middle deep impact socket



46560		l		
Part no.	Socket	mm	g	pc/box
4656021	21	60	228	1
4656022	22	60	228	1
4656023	23	60	227	1
4656024	24	60	226	1
46585		l		
Part no.	Socket	mm	g	pc/box
4658526	26	85	384	1
4658527	27	85	392	1
4658530	30	85	456	1
4658532	32	85	450	1

465100		l		
Part no.	Socket	mm	g	pc/box
46510036	36	100	726	1
46510037	37	100	748	1
46510038	38	100	700	1
46510039	39	100	828	1
46510040	40	100	848	1
46510041	41	100	866	1
46510042	42	100	936	1
46510043	43	100	1133	1
46510044	44	100	1151	1
46510045	45	100	1237	1
46510046	46	100	1176	1
46510047	47	100	1390	1
46510048	48	100	1282	1
46510050	50	100	1312	1
46510052 NEW	52	100	1546	1
46510054 NEW	54	100	1675	1
46510055	55	100	1358	1
46510057 NEW	57	100	1830	1
46510058 NEW	58	100	1870	1
46510059 NEW	59	100	1868	1
46510060	60	100	1734	1
46510063 NEW	63	100	1809	1
46510065	65	100	1710	1

3/4"DR. 6pt. Flank deep impact socket



465100		l		
Part no.	Socket	mm	g	pc/box
46510017	17	100	352	1
46510018	18	100	368	1
46510019	19	100	377	1
46510020	20	100	390	1
46510021	21	100	411	1
46510022	22	100	430	1
46510023	23	100	450	1
46510024	24	100	460	1
46510025	25	100	476	1
46510026	26	100	480	1
46510027	27	100	506	1
46510028	28	100	577	1
46510029	29	100	591	1
46510030	30	100	592	1
46510031 NEW	31	100	602	1
46510032	32	100	657	1
46510033	33	100	660	1
46510034	34	100	710	1
46510035	35	100	728	1

46510011.16	11/16"	100	387	1
4651003.4	3/4"	100	434	1
46510013.16	13/16"	100	456	1
4651007.8	7/8"	100	496	1
46510015.16	15/16"	100	512	1
4651001.0	1"	100	480	1
4651001.1.16	1-1/16"	100	506	1
4651001.1.8	1-1/8"	100	568	1
4651001.3.16	1-3/16"	100	626	1
4651001.1.4	1-1/4"	100	598	1
4651001.5.16	1-5/16"	100	638	1
4651001.3.8	1-3/8"	100	714	1
4651001.7.16	1-7/16"	100	770	1
4651001.1.2	1-1/2"	100	848	1
4651001.9.16	1-9/16"	100	856	1
4651001.5.8	1-5/8"	100	852	1
4651001.11.16	1-11/16"	100	1028	1
4651001.3.4	1-3/4"	100	1190	1
4651001.13.16	1-13/16"	100	1148	1
4651001.7.8	1-7/8"	100	1316	1
4651002.0	2"	100	1430	1
4651001.15.16	1-15/16"	100	1416	1

3/4"DR. Star impact socket

NEW



466		<i>l</i>		
Part no.	Socket	mm	g	pc/box
46618	E18	55	280	2
46620	E20	55	300	2
46622	E22	55	348	2
46624	E24	55	350	2
46626	E26	55	354	2
46628	E28	55	389	2
46630	E30	55	410	2
46632	E32	55	422	2

3/4"DR. 12pt. Flank impact socket



468		<i>l</i>		
Part no.	Socket	mm	g	pc/box
46817	17	50	248	2
46818	18	50	219	2
46819	19	50	252	2
46820	20	50	230	2
46821	21	50	232	2
46822	22	50	350	2
46823	23	50	360	2
46824	24	50	360	2
46826	26	50	336	2
46827	27	54	323	2
46828	28	54	356	2
46829	29	54	354	2
46830	30	54	360	2
46831	31	54	370	2
46832	32	57	370	2
46833	33	57	400	1
46834	34	57	418	1
46835	35	57	400	1
46836	36	57	420	1
46837	37	57	444	1
46838	38	57	454	1
46839	39	57	478	1
46841	41	57	490	1
46842	42	57	582	1
46843	43	63	650	1
46844	44	63	663	1
46846	46	63	740	1
46850	50	68	1068	1

3/4"DR. Star deep impact socket



466110		<i>l</i>		
Part no.	Socket	mm	g	pc/box
46611018	E18	110	520	1
46611020	E20	110	540	1
46611022	E22	110	580	1
46611024	E24	110	591	1
46611028	E28	110	708	1

3/4"DR. Impact extension (pin type)



8046...MPP	<i>l</i>		
Part no.	mm	g	pc/box
8046100MPP	100-4"	641	2
8046175MPP	175-7"	923	2
8046250MPP	250-10"	1223	2
8046330MPP	330-13"	1544	1

3/4"DR. Impact extension (ball type)



8046..MPB	<i>l</i>		
Part no.	mm	g	pc/box
8046100MPB	100-4"	325	2
8046150MPB	150-6"	797	2
8046175MPB	175-7"	927	2
8046200MPB	200-8"	993	2
8046250MPB	250-10"	1224	2
8046330MPB	330-13"	1546	1

3/4"DR. Impact universal joint (pin type)



80561MPP	<i>l</i>		
Part no.	mm	g	pc/box
80561MPP	110	602	1

3/4"DR. Impact universal joint (ball type)



80561MPB	<i>l</i>		
Part no.	mm	g	pc/box
80561MPB	110	624	1

3/4"DR. Impact adaptor (pin type)



8096...MPP	<i>l</i>			
Part no.	Size	mm	g	pc/box
80964MPP	3/4"(F)x1/2"(M)	58	334	2
80968MPP	3/4"(F)x1"(M)	63	430	2

3/4"DR. Impact adaptor (ball type)



8096...MPB	<i>l</i>			
Part no.	Size	mm	g	pc/box
80964MPB	3/4"(F)x1/2"(M)	58	320	2
80968MPB	3/4"(F)x1"(M)	63	400	2

O-ring & Pin for 3/4"DR.



Part no.	○ mm	— mm	⚖ g
R3355 P3040	ø33- ø5.5	30L- ø4.0	3
R3755 P3540	ø37- ø5.5	35L- ø4.0	3
R4455 P4540	ø44- ø5.5	45L-ø4.0	3

Part mapping for 3/4"DR.

Tool No.	O-ring	Pin
26490 14...32	R3755	P3540
26490 9.16...1.1.4	R3755	P3540
461 17...21	R3755	P3540
461 11.16...13.16	R3755	P3540
46190 17...22	R3755	P3540
46190 11.16...13.16	R3755	P3540
465 17...27	R3355	P3040
465 28...46	R3755	P3540
465 47...70	R4455	P4540
465 3.4...1.1.16	R3355	P3040
465 1.1.8...1.13.16	R3755	P3540
465 1.7.8...2.3.4	R4455	P4540
46560 21...24	R3355	P3040
46585 26...27	R3355	P3040
46585 30...32	R3755	P3540
465100 17...27	R3355	P3040
465100 28...46	R3755	P3540
465100 47...65	R4455	P4540
465100 11.16...1.1.16	R3355	P3040
465100 1.1.8...1.13.16	R3755	P3540
465100 1.7.8...1.15.16	R4455	P4540
466 18...32	R3755	P3540
466110 18...28	R3755	P3540
468 17...27	R3355	P3040
468 28...46	R3755	P3540
46850	R4455	P4540
8046 100MPP...330MPP	R3355	P3040
8046 100MPB...330MPB	R3355	P3040
80561MPP	R3355	P3040
80561MPB	R3355	P3040
80964MPP	R3355	P3040
80964MPB	R3355	P3040

3/4"DR. Light duty impact wrench



Part no.	l mm	⚖ g	📦 pc/box
82562	180-7"	2700	1

Specifications :

Square Drive 3/4"
 Free Speed (R.P.M.) 9000
 Working Torque Range (ft/lbs) / (Nm) 50-600 / 68-810
 Max Torque (ft/lbs) / (Nm) 1260 / 1708
 Air Pressure (PSI) 90
 Air Inlet(P.T.) 1/4".

3/4"DR. Impact wrench

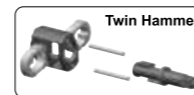

Part no.	l mm	⚖ g	📦 pc/box
82563	234-9.2"	4550	1

Specifications :

Square Drive 3/4"
 Free Speed (R.P.M.) 6500
 Max Torque (ft/lbs) / (Nm) 1234 / 1673
 Air Pressure (PSI) 90
 Air Inlet(P.T.) 1/4".
 Air Consumption (C.F.M.) 7

• Handle exhaust with muffler

3/4"DR. Super duty impact wrench

NEW

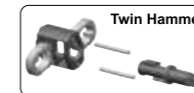

Part no.	l mm	⚖ g	📦 pc/box
82566	210-8.27"	4600	1



Specifications :



Square Drive 3/4"
 Free Speed (R.P.M.) 5500
 Working Torque Range (ft/lbs) / (Nm) 200-900 / 271-1220
 Max Torque (ft/lbs) / (Nm) 1410 / 1912
 Air Pressure (PSI) 90
 Air Inlet(P.T.) 3/8".
 Air Consumption (C.F.M.) 3.25

• Special Features: Six-position power management operated by turnknob forward and reverse.

7pc 1"DR. 6pt. Flank impact socket set







8071  2/28.0/29.0/1.1'  14kg

 	7pc	46; 50; 55; 60; 65; 70; 75 mm
---	-----	-------------------------------

8pc 1"DR. 6pt. Flank impact socket set









8081  4/24.6/25.6/0.8'  6150g

 	8pc	24; 27; 30; 32; 33; 36; 38; 41 mm
---	-----	-----------------------------------

8pc 1"DR. Impact socket set







8082  4/24.6/25.6/0.8'  6150g

 	3pc	17; 19; 21 mm
 	5pc	27; 32; 35; 38; 41 mm

8pc 1"DR. 6pt. Flank impact socket set







8083  2/14.0/15.0/0.8'  7000g

 	8pc	22; 24; 27; 30; 32; 36; 41; 46 mm
---	-----	-----------------------------------

8pc 1"DR. 6pt. Flank deep impact socket set









8081D  2/18.4/19.4/0.6'  9200g

 	8pc	24; 27; 30; 32; 33; 36; 38; 41 mm (100mmL)
---	-----	--

8pc 1"DR. Deep impact socket set







8082D  2/18.4/19.4/0.6'  9200g

 	3pc	17; 19; 21 mm (90mmL)
 	5pc	27; 32; 35; 38; 41 mm (100mmL)

8pc 1"DR. 6pt. Flank impact socket set (SAE)









8081S  4/24.6/25.6/0.8'  6150g

 	8pc	15/16"; 1-1/16"; 1-3/16"; 1-1/4"; 1-5/16"; 1-7/16"; 1-1/2"; 1-5/8"
---	-----	---

8pc 1"DR. Impact socket set (SAE)





8082S  4/24.6/25.6/0.8'  6150g

 	2pc	3/4"; 13/16"
 	6pc	1-1/16"; 1-1/8"; 1-3/16"; 1-1/4"; 1-3/8"; 1-1/2"

8pc 1"DR. 6pt. Flank deep impact socket set (SAE)







8081DS  2/18.4/19.4/0.6'  9200g

	8pc	15/16"; 1-1/16"; 1-3/16"; 1-1/4"; 1-5/16"; 1-7/16"; 1-1/2"; 1-5/8" (100mmL)
---	-----	--

8pc 1"DR. Deep impact socket set (SAE)







8082DS  2/18.4/19.4/0.6'  9200g

	2pc	3/4"; 13/16" (90mmL)
	6pc	1-1/16"; 1-1/8"; 1-3/16"; 1-1/4"; 1-3/8"; 1-1/2" (100mmL)

15pc Impact accessory set







T8151  6/17.7/18.7/0.66'  2954g

	8pc	Ball type 1/4"(F)x3/8"(M); 3/8"(F)x1/4"(M); 3/8"(F)x1/2"(M); 1/2"(F)x3/8"(M); 1/2"(F)x3/4"(M); 3/4"(F)x1/2"(M); 3/4"(F)x1"(M); 1"(F)x3/4"(M)
	3pc	Ball type 3/8"DR.; 1/2"DR.; 3/4"DR.
	4pc	3/8"DR.x1/4"(F); 3/8"DR.x5/16"(F); 1/2"DR.x1/4"(F); 1/2"DR.x5/16"(F)

10pc 1"DR. Impact wrench & socket set







8091  1/20.8/21.8/2.5'  20.8kg

	8pc	27; 30; 32; 33; 35; 36; 38; 41 mm
	1pc	Impact wrench Max. 2756 Nm (82585)
	1pc	Mini oiler

10pc 1"DR. Impact wrench & socket set







8091MD  1/21.0/22.0/2.5'  21kg

	8pc	27; 30; 32; 33; 35; 36; 38; 41 mm (80mmL)
	1pc	Impact wrench Max. 2756 Nm (82585)
	1pc	Mini oiler

10pc 1"DR. Impact wrench & socket set



8091D  1/21.7/22.7/2.5'  21.7kg

	8pc	27; 30; 32; 33; 35; 36; 38; 41 mm (100mmL)
	1pc	Impact wrench Max. 2756 Nm (82585)
	1pc	Mini oiler

1"DR. Hex impact socket bit (one-piece)

NEW



Part no.	Socket	l mm	g	pc/box
28411014	14	110	659	1
28411017	17	110	707	1
28411019	19	110	741	1
28411022	22	110	812	1
28411024	24	110	857	1
28411027	27	110	937	1
28411030	30	110	1014	1
28411032	32	110	1084	1
28411033	33	110	1116	1
28411036	36	110	1209	1
28411038	38	110	1295	1
28411041	41	110	1398	1

1"DR. Square deep impact socket



Part no.	Socket	l mm	g	pc/box
48190				
4819017	17	90	780	1
4819019	19	90	850	1
4819020 NEW	20	90	888	1
4819021	21	90	990	1
4819011.16	11/16"	90	770	1
481903.4	3/4"	90	850	1
4819013.16	13/16"	90	980	1

1"DR. Rectangular deep socket



Part no.	size	l mm	g kg	pc/box
48311021	21 x 28 mm	110	1.44	2

1"DR. Rear wheel nut socket



Part no.	Socket	middle	l mm	g	pc/box
484					
4843517	35	17	100	1168	1
4843820	38	20	100	1260	1
4844121	41	21	100	1326	1
4843820S	1-1/2"	13/16"	100	1260	1

1"DR. 6pt. Flank impact socket



Part no.	Socket	l mm	g	pc/box
485				
48517	17	58	566	1
48518 NEW	18	58	577	1
48519	19	58	640	1
48520	20	58	630	1
48521	21	58	628	1
48522	22	58	628	1
48523	23	58	644	1
48524	24	58	644	1
48525	25	58	636	1
48526	26	58	634	1
48527	27	58	632	1
48528	28	58	642	1
48529	29	58	660	1
48530	30	60	656	1
48531 NEW	31	60	665	1
48532	32	60	664	1
48533	33	60	664	1
48534	34	62	694	1
48535	35	62	674	1
48536	36	65	684	1
48537	37	65	658	1
48538	38	65	674	1
48539	39	65	748	1
48540	40	67	785	1
48541	41	67	760	1
48542	42	70	760	1
48543	43	70	844	1
48544	44	70	928	1
48545	45	70	990	1
48546	46	75	1124	1
48547	47	75	1015	1
48548	48	75	1065	1
48550	50	75	1081	1
48552	52	75	1096	1
48554	54	80	1242	1
48555	55	80	1238	1
48557	57	80	1500	1
48558	58	85	1422	1
48560	60	85	1748	1
48563	63	85	1864	1
48565	65	85	1642	1
48567	67	90	1642	1
48570	70	90	1690	1
48571	71	95	2620	1

1"DR. Square impact socket



Part no.	Socket	l mm	g	pc/box
481				
48117	17	60	570	1
48119 NEW	19	60	580	1
48120	20	60	645	1
48121	21	60	590	1
48111.16 NEW	11/16"	60	565	1
4813.4	3/4"	60	580	1
48113.16	13/16"	60	585	1
48115.16	15/16"	60	669	1

1"DR. Truck nut impact socket



Part no.	Socket	middle	l mm	g	pc/box
482					
48217	27	17	76	684	1
482175	27	17.5	76	684	1
48219	29	19	76	712	1
48220	30	20	76	712	1
482205	30	20.5	76	712	1
48221	32	21	76	694	1
482215	34	21.5	76	693	1
48222	34	22	76	692	1
48211.16	27	11/16"	76	684	1
4823.4	29	3/4"	76	712	1
48213.16	32	13/16"	76	694	1
4827.8	34	7/8"	76	694	1

1"DR. 6pt. Flank middle deep impact socket

485		<i>l</i>		
Part no.	Socket	mm	g	pc/box
48572	72	95	2820	1
48575	75	95	2532	1
48577	77	100	2598	1
48580	80	100	2774	1
48585	85	110	4330	1
48590	90	110	4100	1
48595	95	110	4400	1
4853.4	3/4"	58	665	1
48513.16	13/16"	58	665	1
4857.8	7/8"	58	660	1
48515.16	15/16"	58	660	1
4851.0	1"	58	650	1
4851.1.16	1-1/16"	58	655	1
4851.1.8	1-1/8"	58	655	1
4851.3.16	1-3/16"	60	670	1
4851.1.4	1-1/4"	60	670	1
4851.5.16	1-5/16"	62	675	1
4851.3.8	1-3/8"	62	675	1
4851.7.16	1-7/16"	65	695	1
4851.1.2	1-1/2"	65	720	1
4851.9.16	1-9/16"	65	765	1
4851.5.8	1-5/8"	70	815	1
4851.11.16	1-11/16"	70	865	1
4851.3.4	1-3/4"	75	910	1
4851.13.16	1-13/16"	75	1015	1
4851.7.8	1-7/8"	75	1065	1
4851.15.16	1-15/16"	75	1085	1
4852.0	2"	75	1250	1
4852.1.16	2-1/16"	75	1370	1
4852.1.8	2-1/8"	80	1405	1
4852.3.16	2-3/16"	80	1565	1
4852.1.4	2-1/4"	85	1605	1
4852.5.16	2-5/16"	85	1675	1
4852.3.8	2-3/8"	85	1875	1
4852.7.16	2-7/16"	85	1980	1
4852.1.2	2-1/2"	85	2055	1
4852.9.16	2-9/16"	85	2170	1
4852.5.8	2-5/8"	90	2295	1
4852.11.16	2-11/16"	90	2425	1
4852.3.4	2-3/4"	90	2510	1
4852.13.16	2-13/16"	95	2745	1
4852.7.8	2-7/8"	95	2910	1
4852.15.16	2-15/16"	95	3590	1
4853.0	3"	100	3715	1
4853.1.16	3-1/16"	100	3840	1
4853.1.8	3-1/8"	100	3960	1
4853.1.4	3-1/4"	110	4185	1
4853.3.8	3-3/8"	110	4285	1
4853.1.2	3-1/2"	110	4485	1



48580		<i>l</i>		
Part no.	Socket	mm	g	pc/box
4858027	27	80	608	1
4858030	30	80	652	1
4858031 <small>NEW</small>	31	80	753	1
4858032	32	80	766	1
4858033	33	80	802	1
4858034 <small>NEW</small>	34	80	759	1
4858035	35	80	798	1
4858036	36	80	808	1
4858038	38	80	826	1
4858041	41	80	818	1

1"DR. 6pt. Flank deep impact socket

485100		<i>l</i>		
Part no.	Socket	mm	g	pc/box
48510024	24	100	932	1
48510025	25	100	879	1
48510026	26	100	932	1
48510027	27	100	952	1
48510028	28	100	1000	1
48510029	29	100	994	1
48510030	30	100	1010	1
48510032	32	100	1096	1
48510033	33	100	1012	1
48510034	34	100	1044	1
48510035	35	100	1052	1
48510036	36	100	1148	1
48510037	37	100	1153	1
48510038	38	100	1044	1
48510041	41	100	1158	1
48510042	42	100	1294	1
48510044 <small>NEW</small>	44	100	1320	1
48510045	45	100	1377	1
48510046	46	100	1314	1
48510048	48	100	1362	1
48510050	50	100	1402	1
48510052 <small>NEW</small>	52	100	1719	1
48510054	54	100	1570	1
48510055	55	100	1696	1
48510058	58	100	1856	1
48510060	60	100	1978	1
48512063	63	120	2120	1
48512065	65	120	2430	1
48512067	67	120	2550	1
48513570	70	135	2690	1
48513572	72	135	2900	1
48513575	75	135	4359	1
48513577	77	135	4104	1



485100		<i>l</i>		
Part no.	Socket	mm	g	pc/box
48510015.16	15/16"	100	885	1
4851001.0	1"	100	975	1
4851001.1.16	1-1/16"	100	1055	1
4851001.1.8	1-1/8"	100	1075	1
4851001.3.16	1-3/16"	100	1130	1
4851001.1.4	1-1/4"	100	1115	1
4851001.5.16	1-5/16"	100	1120	1
4851001.3.8	1-3/8"	100	1125	1
4851001.7.16	1-7/16"	100	1165	1
4851001.1.2	1-1/2"	100	1120	1
4851001.9.16	1-9/16"	100	1265	1
4851001.5.8	1-5/8"	100	1285	1
4851001.11.16	1-11/16"	100	1410	1
4851001.3.4	1-3/4"	100	1485	1
4851001.13.16	1-13/16"	100	1500	1
4851001.7.8	1-7/8"	100	1550	1
4851001.15.16	1-15/16"	100	1560	1
4851002.0	2"	100	1650	1
4851002.1.16	2-1/16"	100	1730	1
4851002.1.8	2-1/8"	100	1750	1
4851002.3.16	2-3/16"	100	1900	1
4851002.1.4	2-1/4"	100	1980	1
4851002.5.16	2-5/16"	100	2100	1
4851002.3.8	2-3/8"	100	2450	1
4851202.7.16	2-7/16"	120	2580	1
4851202.1.2	2-1/2"	120	2465	1

1"DR. 12pt. Flank impact socket



488		<i>l</i>		
Part no.	Socket	mm	g	pc/box
48850	50	75	1300	1
48855	55	80	1500	1
48860 <small>NEW</small>	60	85	1593	1
48865	65	85	1655	1

1"DR. Impact extension (pin type)



8048...MPP	l		
Part no.	mm	g	pc/box
8048100MPP	100-4"	935	2
8048175MPP	175-7"	1476	2
8048250MPP	250-10"	1961	2
8048330MPP	330-13"	2702	1

1"DR. Impact extension (ball type)



8048...MPB	l		
Part no.	mm	g	pc/box
8048100MPB	100-4"	935	2
8048175MPB	175-7"	1476	2
8048200MPB <small>NEW</small>	200-8"	1651	2
8048250MPB	250-10"	2050	2
8048330MPB	330-13"	2578	1

1"DR. Impact universal joint (pin type)



80581MPP	l		
Part no.	mm	g	pc/box
80581MPP	135	1626	1

1"DR. Impact universal joint (ball type)



80581MPB	l		
Part no.	mm	g	pc/box
80581MPB	135	1626	1

1"DR. Impact adaptor (pin type)



8098...MPP		l		
Part no.	Size	mm	g	pc/box
80986MPP	1"(F)x3/4"(M)	75	1070	2
809812MPP	1"(F)x1-1/2"(M)	80	1506	1

1"DR. Impact adaptor (ball type)



80986MPB		l		
Part no.	Size	mm	g	pc/box
80986MPB	1"(F)x3/4"(M)	75	596	2

O-ring & Pin for 1"DR.



Part no.			
	mm	mm	g
R4455	Ø44- Ø5.5		4
P4550		45L- Ø5.0	4
R7555	Ø75- Ø5.5		4
P7550		75L- Ø5.0	4

Part mapping for 1"DR.

Tool No.	O-ring	Pin
284110 14...41	R4455	P4550
481 17...21	R4455	P4550
481 11.16...13.16	R4455	P4550
48190 17...21	R4455	P4550
48190 11.16...13.16	R4455	P4550
482 17...22	R4455	P4550
482 11.16...7.8	R4455	P4550
484 3517...4121	R4455	P4550
4843820S	R4455	P4550
485 17...70	R4455	P4550
485 71...95	R7555	P7550
485 3.4...2.3.4	R4455	P4550
485 2.13.16...3.1.2	R7555	P7550
48580 27...41	R4455	P4550
485100 24...60	R4455	P4550
485120 63...67	R4455	P4550
48513570	R4455	P4550
485135 72...77	R7555	P7550
485100 15.16...2.3.8	R4455	P4550
485120 2.7.16...2.1.2	R4455	P4550
488 50...65	R4455	P4550
8048 100MPP...330MPP	R4455	P4550
8048 100MPB...330MPB	R4455	P4550
80581MPP	R4455	P4550
80581MPB	R4455	P4550
809 86MPP...812MPP	R4455	P4550
80986MPB	R4455	P4550

1"DR. Impact wrench with 6" anvil

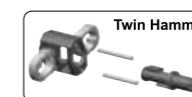

82585	l		
Part no.	mm	kg	pc/box
82585	518-20"	12.5	1

Specifications :
 Square Drive1"
 Free Speed (R.P.M.)4000
 Max Torque (ft/lbs) / (Nm)2033/2756
 Air Pressure (PSI)90
 Air Inlet(P.T.)1/2".
 Air Consumption (C.F.M.)12
 • Side exhaust

1"DR. Impact wrench

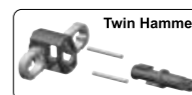

82585S	l		
Part no.	mm	kg	pc/box
82585S	365-14.5"	10	1

Specifications :
 Square Drive1"
 Free Speed (R.P.M.)4000
 Max Torque (ft/lbs) / (Nm)2033/2756
 Air Pressure (PSI)90
 Air Inlet(P.T.)1/2".
 Air Consumption (C.F.M.)12

1"DR. Super duty impact wrench

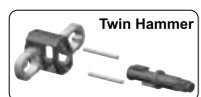

82586	l		
Part no.	mm	kg	pc/box
82586	367-14.5"	10.6	1

Specifications :

Square Drive1"
 Free Speed (R.P.M.)4000
 Max Torque (ft/lbs) / (Nm)2300/3118
 Air Pressure (PSI)90
 Air Inlet(P.T.)1/2".

1"DR. Super duty impact wrench with 6" anvil

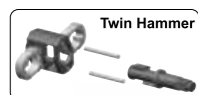

82586L	l		
Part no.	mm	kg	pc/box
82586L	533-21"	11.1	1

Specifications :

Square Drive1"
 Free Speed (R.P.M.)4000
 Max Torque (ft/lbs) / (Nm)2300/3118
 Air Pressure (PSI)90
 Air Inlet(P.T.)1/2".

1-1/2"DR. 6pt. Flank impact socket



4125		l		
Part no.	Socket	mm	kg	pc/box
412541	41	80	2.2	1
412542	42	80	2.3	1
412546	46	84	2.3	1
412550	50	84	2.4	1
412552	52	84	2.4	1
412554	54	84	2.3	1
412555	55	90	2.5	1
412558	58	90	2.3	1
412560	60	90	2.6	1
412565	65	95	3.0	1
412570	70	100	3.4	1
412575	75	105	3.6	1
412580	80	110	4.6	1
412585	85	110	5.7	1
412590	90	112	5.7	1
412595	95	112	9.2	1
4125100	100	115	9.9	1
4125105	105	120	11.0	1
4125110	110	124	12.6	1
4125115	115	128	13	1
4125120	120	132	14.7	1
4125125	125	136	16.1	1
4125130	130	140	16.7	1
4125135	135	125	19.0	1
4125140	140	150	19.6	1
4125150	150	160	23.0	1
41251.5.8	1-5/8"	80	2.2	1
41251.11.16	1-11/16"	80	2.3	1
41251.3.4	1-3/4"	80	2.3	1
41251.13.16	1-13/16"	84	2.4	1
41251.15.16	1-15/16"	84	2.5	1
41252.0	2"	84	2.5	1
41252.1.16	2-1/16"	84	2.5	1
41252.1.8	2-1/8"	84	2.3	1
41252.3.16	2-3/16"	90	2.7	1
41252.1.4	2-1/4"	90	2.7	1
41252.5.16	2-5/16"	90	2.8	1
41252.3.8	2-3/8"	90	2.8	1
41252.7.16	2-7/16"	95	2.9	1
41252.1.2	2-1/2"	95	2.9	1

4125		l		
Part no.	Socket	mm	kg	pc/box
41252.9.16	2-9/16"	95	3.0	1
41252.5.8	2-5/8"	100	3.2	1
41252.11.16	2-11/16"	100	3.4	1
41252.3.4	2-3/4"	100	3.4	1
41252.13.16	2-13/16"	105	3.5	1
41252.7.8	2-7/8"	105	3.6	1
41252.15.16	2-15/16"	105	3.7	1
41253.0	3"	105	4.4	1
41253.1.8	3-1/8"	110	4.4	1
41253.1.4	3-1/4"	110	4.4	1
41253.3.8	3-3/8"	110	5.7	1
41253.1.2	3-1/2"	112	5.7	1
41253.5.8	3-5/8"	112	9.0	1
41253.3.4	3-3/4"	112	9.2	1
41253.7.8	3-7/8"	115	9.9	1
41254.0	4"	120	10.2	1
41254.1.8	4-1/8"	120	10.9	1
41254.1.4	4-1/4"	124	11.0	1
41254.1.2	4-1/2"	128	13.0	1
41254.3.4	4-3/4"	132	14.7	1
41255.0	5"	140	16.7	1
41255.1.4	5-1/4"	145	19.0	1
41256.0	6"	265	23.0	1
41256.1.2	6-1/2"	1655	26.0	1

1-1/2"DR. 6pt. Flank deep impact socket



4125D		<i>l</i>		
Part no.	Socket	mm	kg	pc/box
4125D41	41	115	3	1
4125D42	42	115	3	1
4125D46	46	125	3.4	1
4125D50	50	135	3.8	1
4125D54	54	135	4	1
4125D55	55	135	4.1	1
4125D60	60	135	4.3	1
4125D65	65	150	5.2	1
4125D70	70	160	5.7	1
4125D75	75	170	6.5	1
4125D80	80	170	7.2	1
4125D85	85	170	7.4	1
4125D90	90	170	9.4	1
4125D95	95	180	10	1
4125D100	100	190	10.5	1
4125D105	105	195	11	1
4125D110	110	200	11.5	1
4125D115	115	210	12.0	1
4125D120	120	210	13.0	1
4125D125	125	220	14.0	1
4125D130	130	220	15.0	1
4125D1.5.8	1-5/8"	115	3.0	1
4125D1.11.16	1-11/16"	115	3.1	1
4125D1.3.4	1-3/4"	115	3.2	1
4125D1.13.16	1-13/16"	115	3.4	1
4125D1.7.8	1-7/8"	115	3.5	1
4125D1.15.16	1-15/16"	115	3.6	1
4125D2.0	2"	135	3.8	1
4125D2.1.16	2-1/16"	140	3.9	1
4125D2.1.8	2-1/8"	140	4.0	1
4125D2.3.16	2-3/16"	140	4.1	1
4125D2.1.4	2-1/4"	150	4.2	1
4125D2.3.8	2-3/8"	150	4.3	1

4125D		<i>l</i>		
Part no.	Socket	mm	kg	pc/box
4125D2.7.16	2-7/16"	150	4.4	1
4125D2.1.2	2-1/2"	150	4.6	1
4125D2.9.16	2-9/16"	150	5.2	1
4125D2.5.8	2-5/8"	150	5.3	1
4125D2.11.16	2-11/16"	150	5.5	1
4125D2.3.4	2-3/4"	160	5.7	1
4125D2.13.16	2-13/16"	160	5.9	1
4125D2.7.8	2-7/8"	160	6.1	1
4125D2.15.16	2-15/16"	170	6.5	1
4125D3.0	3"	170	6.8	1
4125D3.1.8	3-1/8"	170	7.5	1
4125D3.3.4	3-3/4"	180	10.0	1
4125D3.7.8	3-7/8"	190	11.0	1

1-1/2"DR. Impact extension (pin type)



80412...MPP	<i>l</i>		
Part no.	mm	kg	pc/box
80412250MPP	250-10"	5	1
80412330MPP	330-13"	5.2	2
80412380MPP	380-15"	6.6	1
80412500MPP	500-20"	8.4	1

1-1/2"DR. Impact wrench

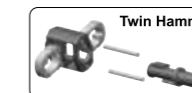

825121	<i>l</i>		
Part no.	mm	kg	pc/box
825121	452-17.8"	15.8	1

Specifications :

- Square Drive1-1/2"
- Free Speed (R.P.M.)3000
- Max Torque (ft/lbs) / (Nm)3860/5250
- Air Pressure (PSI)90
- Air Inlet(P.T.)1/2"
- Air Consumption (C.F.M.)14.5
- Side exhaust

1-1/2"DR. Impact adaptor (pin type)



80912...MPP	<i>l</i>			
Part no.	size	mm	kg	pc/box
809128MPP	1-1/2"(F)x1"(M)	98	2.5	1
8091220MPP	1-1/2"(F)x2-1/2"(M)	115	3.8	1

2-1/2"DR. 6pt. Flank impact socket



4205		<i>l</i>		
Part no.	Socket	mm	kg	pc/box
420550	50	115	7.2	1
420555	55	115	7.3	1
420560	60	125	7.5	1
420565	65	125	7.6	1
420570	70	125	7.7	1
420575	75	125	7.8	1
420580	80	125	7.9	1
420585	85	132	8.0	1
420590	90	132	8.3	1
420595	95	140	10.0	1
4205100	100	142	11.0	1
4205105	105	146	11.5	1
4205110	110	155	12.0	1
4205115	115	158	13.5	1
4205120	120	160	15.0	1
4205125	125	165	16.0	1
4205130	130	170	17.5	1
4205135	135	175	19.0	1
4205140	140	180	21.0	1
4205145	145	183	23.0	1
4205150	150	192	25.5	1
4205160	160	200	30.0	1
4205165	165	204	32.0	1
4205170	170	207	34.0	1
4205175	175	210	36.0	1
4205180	180	214	40.0	1
4205185	185	218	42.0	1
4205190	190	220	47.0	1
4205200	200	225	51.0	1
4205210	210	235	57.0	1
4205215	215	240	60.0	1
4205225	225	250	70.0	1
4205235	235	260	77.0	1

4205		<i>l</i>		
Part no.	Socket	mm	kg	pc/box
42052.3.8	2-3/8"	125	7.2	1
42052.7.16	2-7/16"	125	7.3	1
42052.1.2	2-1/2"	125	7.4	1
42052.9.16	2-9/16"	125	7.5	1
42052.5.8	2-5/8"	125	7.6	1
42052.11.16	2-11/16"	125	7.7	1
42052.3.4	2-3/4"	125	7.8	1
42052.13.16	2-13/16"	125	7.8	1
42052.7.8	2-7/8"	125	7.9	1
42052.15.16	2-15/16"	125	8.0	1
42053.0	3"	125	8.0	1
42053.1.8	3-1/8"	125	8.1	1
42053.1.4	3-1/4"	125	8.1	1
42053.3.8	3-3/8"	132	8.2	1
42053.5.8	3-5/8"	132	8.8	1
42053.3.4	3-3/4"	140	10.0	1
42053.7.8	3-7/8"	140	10.5	1
42054.0	4"	142	11.0	1
42054.1.8	4-1/8"	142	11.5	1
42054.1.4	4-1/4"	155	12.0	1
42054.1.2	4-1/2"	158	13.0	1
42054.5.8	4-5/8"	160	14.0	1
42054.7.8	4-7/8"	165	16.0	1
42055.0	5"	165	17.0	1
42055.1.4	5-1/4"	175	19.0	1
42055.3.8	5-3/8"	180	20.0	1
42055.1.2	5-1/2"	180	21.0	1
42055.5.8	5-5/8"	182	22.0	1
42055.3.4	5-3/4"	192	24.0	1
42056.0	6"	196	28.0	1
42056.1.8	6-1/8"	196	29.0	1
42056.5.8	6-5/8"	205	33.0	1
42057.0	7"	213	39.0	1

2-1/2"DR. 6pt. Flank deep impact socket



4205D		<i>l</i>		
Part no.	Socket	mm	kg	pc/box
4205D75	75	190	11.0	1
4205D80	80	190	12.0	1
4205D85	85	195	13.0	1
4205D90	90	205	14.0	1
4205D95	95	210	14.5	1
4205D100	100	215	15.0	1
4205D105	105	220	18.0	1
4205D110	110	225	19.0	1
4205D115	115	230	20.0	1
4205D120	120	235	24.0	1
4205D125	125	238	25.0	1
4205D130	130	243	26.0	1
4205D135	135	248	27.0	1
4205D140	140	248	28.0	1
4205D145	145	248	29.0	1
4205D150	150	255	30.0	1
4205D155	155	255	32.0	1
4205D160	160	260	35.0	1
4205D165	165	260	36.0	1
4205D170	170	265	37.0	1
4205D175	175	270	39.0	1

2-1/2"DR. Impact extension (Pin type)



80420...MPP	<i>l</i>		
Part no.	mm	kg	pc/box
80420250MPP	250-10"	18.0	1
80420500MPP	500-20"	27.0	1

2-1/2"DR. Impact adaptor (pin type)



80920...MPP	<i>l</i>			
Part no.	size	mm	kg	pc/box
8092012MPP	2-1/2"(F)x1-1/2"(M)	145	7.2	1

3-1/2"DR. 6pt. Flank impact socket



4285		<i>l</i>		
Part no.	Socket	mm	kg	pc/box
4285105	105	176	19.0	1
4285110	110	179	20.0	1
4285115	115	183	21.0	1
4285120	120	185	22.0	1
4285125	125	190	23.0	1
4285130	130	194	25.0	1
4285135	135	200	27.0	1
4285140	140	205	28.0	1
4285145	145	207	30.0	1
4285150	150	212	31.0	1
4285155	155	218	33.0	1
4285160	160	220	35.0	1
4285165	165	224	38.0	1
4285170	170	227	39.0	1
4285175	175	230	41.0	1
4285180	180	234	45.0	1
4285185	185	238	50.0	1
4285190	190	240	54.0	1
4285200	200	245	59.0	1
4285210	210	255	65.0	1
4285215	215	260	68.0	1
4285225	225	270	76.0	1
4285235	235	280	80.0	1

1/2"DR. Cordless impact wrench (18V, LI-ION)

NEW



825A41L

4/19.5/20.5/2.64' 4675g

Features:

- Ventilation of special design.
- Soft-grip switch trigger.
- Slide clip mechanism secures connection between the main unit and the battery.

Specifications:

- Voltage: 18.0V d.c.
- Capacity (Square driver): 1/2" (13mm)
- No-load speed: 0~2000 r.p.m.
- Max. torque: 4100 kg-cm / 401.8 N.m (300 ft-lb)
- Impacts per minute: 2300
- Charging time: 80 minutes (AUTO CUT-OFF)
- Capability: A fully-charged battery pack can tighten and loosen 150 pcs of 21mm wheel nut

*Charger included

825A41L package + one more battery (18V, LI-ION)

NEW



825A41L-B

4/20.4/21.4/2.64' 5100g

	+		1pc	1/2"DR. Cordless impact wrench (825A41L)
			1pc	18V Battery

Cordless drill - keyless 3/8" (14.4V, LI-ION)

NEW



827A31L

6/19.4/20.4/3.1' 3235g

Specifications:

- Voltage: 14.4 V d.c.
- No-load speed: Low: 0-325 High: 0-1170 r.p.m.
- Max. torque: 400 kg-cm / 39.2 N.m (29 ft-lb)
- Chuck capacity: Keyless 3/8" (10mm)
- Clutch: 17 sections
- Charging time: 40 minutes (AUTO CUT-OFF)

*Charger included

827A31L package + one more battery (14.4V, LI-ION)

NEW



827A31L-B

6/22.3/23.3/3.1' 3716g

	+		1pc	Cordless drill - keyless 3/8" (827A31L)
			1pc	14.4V Battery

1/4" Cordless screwdriver (3.6V, LI-ION)



828A21L

6/10.6/11.6/2' 1766g

Specifications:

- Voltage: 3.6 V d.c.
- Capacity: 1/4" inhex
- No-load speed: Low: 220 High: 450 r.p.m.
- Max. torque: 40 kg-cm / 3.92 N.m (2.9 ft-lb)
- Charging time: 1 hour (AUTO CUT-OFF)
- Capability: A fully charged battery pack can tighten 457pcs of TP3x12mmL carpenter screw to a pine board

*Charger included

828A21L package + one more battery (3.6V, LI-ION)



828A21L+825B036L

6/11.3/12.3/2' 1883g

	+		1pc	Cordless impact screwdriver (828A21L)
			1pc	3.6V Battery

1/4" Cordless impact wrench (12V)



828A22

6/25.8/26.8/2.5' 4300g

Specifications:

- Voltage: 12V d.c.
- Capacity: 1/4" inhex
- No-load speed: 0~2300 r.p.m.
- Max. torque: 1000 kg-cm / 98 N.m (72 ft-lb)
- Impacts per minute: 3000
- Charging time: 1 hour (AUTO CUT-OFF)
- Capability: A fully-charged battery pack can tighten 170 pcs of 4.1x38mmL carpenter screw to a pine board

*Charger included

828A22 package + one more battery (12V)



828A22+825B120

6/26.5/27.5/2.5' 4416g

	+		1pc	1/4" Cordless impact wrench (828A22)
			1pc	12V Battery

PH.2 Bit with limiter



121A		<i>l</i>		
Part no	Size	mm	g	packing
121A252	PH.2	25	19.5	400/7.8/8.8/1.2'
121A502	PH.2	50	25.5	400/10.2/11.2/1.2'

1/4" Magnetic nut setter

NEW



812M		<i>l</i>		
Part no	Size	mm	g	pc/box
812M06	6	65	25	10
812M07	7	65	26	10
812M08	8	65	31	10
812M10	10	65	36	10
812M13	13	65	53	10
812M5.16	5/16"	65	31	10
812M3.8	3/8"	65	36	10
812M7.16	7/16"	65	42	10

Magnetic screw bit holder



827B02

400/3.2/4.2/0.58' 8g

- Width: 14mm
- Length: 24mm

Angle drill tool with quick release



827B03

48/18.7/19.7/0.8' 390g

- 1/4" Hex shank.
- 1/4" Bit holder with quick release.
- Adjustable mini handle attached to quick locking sleeve allows users to rotate it 360°.
- Transmit the spinning smoothly at the 90° direction switch.
- Reach most difficult space.

Part No.	Page	Part No.	Page	Part No.	Page	Part No.	Page	Part No.	Page	Part No.	Page
10215	1-10	156...	4-54	2087A	4-27	2141T	4-46	2461	5-7	3078A	6-7
10215A	1-10	157...	4-55	2088A	4-27	2142	4-17	2461-5	5-7	3082	6-1
10215B	1-10	174...	4-55	2088AT	4-28	2143	4-17	2462-7	5-8	3082S	6-2
10215R	1-10	174S...	4-55	20915	4-17	2144Q	5-2	2462-9	5-8	3083	10-4
10216	1-11	176...	4-56	20916N	4-24	2203	5-5	248...	10-28	3083S	10-4
10216A	1-11	177...	4-56	20917	4-25	2203-5	5-5	248060...	10-28	3084	10-4
10216B	1-11	178...	4-57	20918	4-7	2203-72	5-5	248078...	10-28	3084S	10-4
10216R	1-11	179...	4-57	2095	4-46	2203-72-5	5-5	2481	5-14	3086	6-6
10217	1-11	196...	4-57	2095S	4-46	2203S-5	5-12	2501A	5-14	3086T	6-6
10217A	1-11	2044	4-20	2096	4-47	2203S-9	5-12	2501B	5-15	30911	6-7
10217B	1-11	2044S	4-20	2097	4-45	2222	4-7	2561	5-8	30912	6-7
10217R	1-11	2044ST	4-21	2097B	4-45	2253	5-5	2561-27	5-8	3093	6-1
10218	1-12	2045	5-4	2097S	4-45	2253-72	5-5	2561-4	5-8	3094	4-10
10218A	1-12	2048	4-20	2101	4-1	2255	4-8	2561-8	5-8	3094-4	4-10
10218B	1-12	2048T	4-22	21010	4-1	2263	4-8	2561T	5-9	3095	6-7
10218R	1-12	2049	5-4	21011	4-1	2281	5-5	2561T-27	5-9	3098	6-2
10225	1-10	2057	4-45	21011S	4-1	2281-5	5-5	2561T-4	5-9	3099	6-6
10225A	1-10	2058	4-45	21012	4-1	2281-72	5-5	2561T-8	5-9	3101	6-3
10225B	1-10	2059	4-46	21012T	4-2	2281-72-5	5-5	2571	5-9	3103R	6-4
10225R	1-10	2061	4-20	21013	4-2	2281S	5-12	2611A	4-5	3105R	6-4
10318	1-13	20610A	4-18	21016	5-2	2285	5-13	2611B	4-5	3108Q	6-4
10318B	1-13	20611	4-23	21016D	5-2	2292	5-6	2613	4-5	3112	6-4
10318R	1-13	20612	4-23	21017	5-3	2292-7	5-6	2641	5-10	3113S	6-2
10323	1-12	20612N	4-25	2101L	4-1	2292-9	5-6	2641-8	5-10	3113S-5	6-2
10323R	1-12	2061T	4-22	21021	4-5	2303	5-4	2642	5-8	3121	6-2
10517	1-6	2062	5-2	21022	4-6	2311	4-3	26490...	10-44	3122Q	6-4
10517-310	1-6	2062S	5-2	2106A	4-27	2312	5-13	2711	5-10	3127	6-3
10523	1-5	2068	4-16	2108	4-19	2312-5	5-13	2741	5-15	3128	6-1
10526	1-5	2069	4-18	2109	4-19	2312-72	5-13	2742	5-11	3128-9	6-1
10529	1-5	2071	4-1	21110	5-1	2312-72-5	5-13	2742-18	5-11	3128D	6-1
1052D	1-5	20711	5-3	21110-5	5-1	2313	4-3	2742-8	5-11	3128D-9	6-1
121...	4-49	20712N	4-24	21110D	5-1	2313A	4-3	2751	4-26	3131	6-1
121A...	10-70	20713	4-16	21110D-5	5-1	2315	4-4	2752	4-26	3131-9	6-1
121D...	4-49	20714	4-19	21111	4-2	2331	4-4	2753	4-26	3143	6-10
121S...	4-52	20715N	4-24	21112	4-2	2331A	4-4	2753T	4-26	3151	6-2
122...	4-49	20717	4-23	21113	4-2	2332	4-4	284110...	10-55	3151-5	6-2
122D...	4-49	20718N	4-24	21113T	4-3	23452...	10-6	2911	5-11	3171	6-8
122S...	4-52	20718N-3	4-24	21115	5-1	23652...	10-6	2911Q	5-11	3171T	6-8
123...	4-49	20719	4-21	21115-9	5-1	2402	5-13	3039	6-8	3173N	2-83
123D...	4-49	2073	5-3	2111I	5-3	2405Q	5-6	3039W	6-8	3193	6-3
123S...	4-52	2073S	5-3	2112I	5-3	241...	10-26	3051	6-8	321...	5-16
124...	4-50	2081	4-6	2119	4-21	241060...	10-26	3051M	6-8	3212	6-15
124D...	4-50	20810	4-19	2119T	4-22	2413	5-4	3064	6-3	3215	6-9
124R...	4-53	20810B	4-20	2125N	4-25	242....	10-26	3068	6-7	322...	5-16
124S...	4-52	20812	5-3	2126N	4-25	2421	5-6	3071	4-9	3224	6-5
125...	4-50	20812T	5-3	2133	5-1	2421-2	5-6	30710S	6-5	323...	5-16
126...	4-51	2081A	4-6	2133-5	5-1	2421-8	5-6	30712	6-8	3232	6-10
126D...	4-51	2081B	4-6	2134	4-23	2421F	5-7	30715	10-5	3232-7	6-10
127...	4-51	2081C	4-6	2137	4-21	2421S	5-12	30716	10-4	3232-9	6-10
128...	4-51	2081D	4-7	2137T	4-22	243...	10-26	3074	6-3	3233	10-5
12F...	4-52	2083	4-7	2138	5-1	244...	10-26	3075	6-6	324...	5-16
151...	4-53	2084	4-16	2138-5	5-1	244060...	10-27	3075S	6-6	3251	6-11
152...	4-53	2085	4-17	2138Q	5-2	244078...	10-27	3076	6-6	3251-5	6-11
153...	4-53	2086	4-20	2141	4-46	246...	10-27	3076L	6-6	3251-5-18	6-11
154...	4-54	2086T	4-22	21410	4-18	246060...	10-28	3077S	6-5	3251-72	6-11

Part No.	Page	Part No.	Page	Part No.	Page	Part No.	Page	Part No.	Page	Part No.	Page
3251-72-5	6-11	349...T	7-61	4083	7-6	4117	10-16	4166	10-14	4243S-5	7-47
3251-9	6-11	3511	6-13	4084R	7-7	4118	10-21	4166D	10-15	4243S-9	7-47
3251-Q	6-11	3521	6-9	4084SR	7-7	41182	7-37	4171	7-18	4245	7-23
326...	5-16	3552	6-18	4085SR	7-7	41182-27	7-37	41710	7-9	4245-7	7-23
3261	6-11	3611	6-14	4091	7-8	4118-3	10-21	4172	7-18	4245-9	7-23
3261-7	6-11	3611-5	6-14	40911	7-2	4119	10-15	4173	7-22	4245B	7-23
3261-9	6-11	3612	6-14	40911-9	7-2	41201-9	7-33	4173-4	7-22	4245B-7	7-23
327...	5-17	364...	8-6	40912	10-19	4122	7-16	4173-5	7-22	4245B-9	7-23
32F...	5-17	366...	8-6	40913	7-11	4124Q	7-6	4173-9	7-22	4245BS	7-48
3302	6-12	368...T	8-6	40913L	7-11	4125	7-1	4173S	7-47	4245BS-7	7-48
331...	6-19	3681	6-15	40913LT	7-12	4125...	10-62	4173S-5	7-47	4245S	7-48
3313N	2-83	3681-27	6-15	40913T	7-12	4125-9	7-1	4173S-9	7-47	4245S-7	7-48
332...	6-19	3681-4	6-15	40915	7-13	4125D...	10-63	4178	7-3	4245S-9	7-48
3322	6-16	3681-8	6-15	4091S	7-8	4127	7-4	4179	7-13	4246	7-24
3322-15	6-16	4031	2-124	4092	7-9	4127-9	7-4	41801	7-41	4246-5	7-24
3322-23	6-16	4032	10-12	4093	7-5	41311	7-38	41801-27	7-41	4246-9	7-24
3322-24	6-16	4032TH	10-12	4095	7-5	41311-27	7-38	41802	7-35	4246B	7-24
333...	6-19	4033	10-13	4101	7-8	41331D	10-25	4189	10-22	4246B-5	7-24
334...	6-19	4036	2-124	41012	10-17	41331S	10-24	4192	7-19	4246B-9	7-24
335...	6-20	4037	10-13	41012S	10-17	41391	7-39	4193	10-14	4246S	7-49
3351	6-16	4046	10-12	41013	10-17	4142	10-21	4194	7-4	4246S-5	7-49
3351-5	6-16	4049	7-17	41014Q	7-6	41421	7-40	4194-7	7-4	4246SB-5	7-49
3352	6-12	4051	7-10	41015	7-1	41421-9	7-40	4194-9	7-4	4246SB-9	7-49
3352Q	6-12	4056	7-8	41015-9	7-1	4142-9	10-22	4205	10-18	425...	10-2
336...	6-20	4057	7-17	41015D	7-2	4142B	10-22	4205...	10-65	42507M	10-2
3361	6-12	4061	7-13	41015D-9	7-2	4143	7-3	4205D...	10-66	4255	7-24
3361-7	6-12	40612	7-17	41015R	7-7	4143-9	7-3	4206	7-14	42550...	10-2
3361-8	6-12	40613-23	7-17	41018	7-1	41451D	10-24	4212	7-1	4256	10-19
3361-9	6-12	40616	7-6	41018-9	7-1	41451S	10-24	4212-7	7-1	426...	10-2
3362	6-16	4062	7-10	41018D	7-2	41512	7-21	4212-9	7-1	4263	7-14
337...	6-20	4066	4-11	41018D-9	7-2	41531D	7-54	4215	10-23	4265	7-15
338...	6-21	4071	7-4	41019	7-5	41531D-7	7-54	4217	7-3	4266	7-15
3382	6-9	40710A	10-20	41019D	7-6	41531D-9	7-54	4222	4-11	4267	10-19
3382T	6-9	40711	7-2	4101S	7-8	41531S	7-54	4223	7-22	4281	7-16
339...	6-21	40711-9	7-2	4102	7-10	41531S-7	7-54	4223-7	7-22	4283	4-12
3391	6-17	40713	10-18	41021	7-33	41531S-9	7-54	4223-9	7-22	4285	7-14
3391-5	6-17	40715	7-8	4106DS	7-4	4155	4-9	4225	4-12	4285...	10-66
33F...	6-21	40715L	7-9	4106DS-9	7-4	4156	4-10	4226	7-22	4293	10-23
341...	7-57	40716	7-12	4107	10-14	4157	7-18	4226Q	7-22	4312	7-50
342...	7-57	40716L	7-13	41071	7-34	4158	7-5	4234A	7-42	4321	7-51
343...	7-57	40717	7-10	4107-18	10-14	4161	7-21	4234A+2421	7-42	4321-7	7-51
3431	6-17	40717L	7-11	41071-9	7-34	4161-7	7-21	4234A+4091	7-42	4324	7-25
344...	7-57	4072	4-11	4107S	10-16	4161-9	7-21	4234B	7-43	4325	7-50
344...	7-58	4074	4-9	4108	10-18	4162	7-21	4234B+2641	7-43	4326	7-19
3443	6-13	4075	4-9	41082-9	7-35	4162-5	7-21	4234B+2742-8	7-44	435...	10-6
3443-27	6-13	4077	10-17	4109	10-14	4162-7	7-21	4234B+3361	7-44	435...M	10-7
3443-4	6-13	4077S	10-17	4109-18	10-14	4163	7-3	4234B+4143	7-45	4351	4-12
3443-8	6-13	4078	10-17	4109S	10-16	41631D	7-53	4234B+4583	7-45	4352	7-19
345...	7-59</										

Part No.	Page	Part No.	Page	Part No.	Page	Part No.	Page	Part No.	Page	Part No.	Page
4405	7-25	4682-5	7-29	5036	2-19	50652	4-48	5084-24	3-4	5109S	4-34
4405-27	7-25	4682-9	7-29	5036A	2-19	50653	2-18	5084TF	4-40	5109XLBS	4-37
4405-4	7-25	4731	7-20	5036C	2-20	5066	3-1	5085	3-15	5111	3-5
4405-8	7-25	4772	7-29	5036E	2-20	5066S	3-1	5085S	3-16	51110	3-2
4411	7-19	481...	10-55	5038	2-20	5067D	3-4	5086	3-7	5115	3-7
44114	10-28	48190...	10-55	5041	3-14	5067DS	3-5	5086S	3-11	5115S	3-11
4412	7-51	482...	10-55	5042	2-57	5069DS	3-15	5087F	4-38	5116	4-31
4412-5	7-51	4821	7-30	5042S	2-57	5071	4-38	5088	3-17	5116L	4-31
4415	7-51	4821-5	7-30	5043A	2-18	50712	3-17	5088-8	3-15	5116LB	4-36
4416	7-26	4821-9	7-30	5045	2-17	5071T	4-41	5091	4-39	5116XL	4-31
4416-27	7-26	48311021	10-56	5046	2-17	5072	4-29	50910BS	4-44	5116XLB	4-36
4416-4	7-26	484...	10-56	5047	2-17	50721	2-19	50911	3-20	51210M	3-21
4416-8	7-26	485...	10-56	5047P1...	2-24	50722	2-46	50912	4-47	51211M	3-22
4421	4-14	485100...	10-58	5047P2...	2-24	50726	3-21	50913	4-42	51213C	3-18
4421C	4-14	48580...	10-57	5047P3...	2-24	50726F	3-24	50919	4-48	51213P-8	3-15
4421CT	4-14	488...	10-58	5047P4	2-24	5072BF	4-35	5092	4-41	51213SC	3-18
4421T	4-14	4911	7-31	5051	2-125	5072F	4-29	50925SC	3-6	51213SC-8	3-16
443...	2-130	4911-9	7-31	50510	2-45	5072FS	4-32	5093	4-30	51214	3-13
4441C	4-15	4921	7-20	50511	2-46	5072L	4-29	5093L	4-30	51214P	3-13
4441CT	4-15	4941	7-32	50512	2-46	5072LB	4-35	5093LB	4-35	51215	3-22
4442C	4-15	4941-5	7-32	50513	2-48	5072LBS	4-37	5093LBS	4-37	51215R	3-23
4442CT	4-15	4941-9	7-32	5053	2-47	5072LS	4-33	5093LS	4-33	5121C	3-7
4445	7-26	50121	7-55	5054	2-45	5072S	4-33	5093S	4-33	5121SC	3-11
445...	10-29	50121A-429	7-55	5055	2-48	5072XL	4-30	5093XL	4-30	5122	2-125
445120...	10-31	50121B-460	7-56	5055P1...	2-55	5072XLB	4-35	5093XLB	4-36	51229	2-46
445150...C	10-31	50121C-408	7-56	5056	2-48	5072XLBS	4-37	5093XLBS	4-37	5123	3-8
44552...	10-29	50121D-452	7-55	5061	2-125	5072XLS	4-33	5093XLS	4-34	5128C	3-5
44552...TH	10-29	50121E-275	10-25	50610	3-17	5074	3-2	5094	3-7	5131	2-47
44585...	10-30	50121F-271	10-25	50610DS	3-18	5075	3-3	5096	2-71	51313	3-13
44585...C	10-31	5021	2-20	50612	2-125	5076	4-28	5096A8...	2-73	5134	3-11
44585...TH	10-30	50212	1-9	50613	2-45	5076F	4-28	5096P1A	2-72	5135S	3-2
446...	10-31	50223	1-8	50614	2-45	5076FS	4-32	5096P1A30	2-72	5137	4-32
448...	10-32	50223R	1-8	50616S	3-3	5076L	4-29	5096P8...	2-73	5137S	4-34
44885...	10-32	50223S	1-5	50617	3-26	5076S	4-32	5096P8100	2-74	5137XL	4-32
4541	7-27	50229S	1-5	5062	3-14	5076XL	4-29	5096P9...	2-74	5137XLS	4-34
4541-5	7-27	50230-95	1-1	50621L	4-38	5077	3-6	5098	4-39	5141C	3-9
4541-7	7-27	50231-33	1-1	50622	3-19	5077S	3-11	5098L	4-39	5141K	3-8
4583	4-16	50233	1-2	50622A	3-19	5078	2-58	5098LB	4-40	5141SC	3-12
461...	10-44	50233-25	1-4	50623	3-25	5081	3-17	5098LT	4-41	5144	3-21
46190...	10-44	50233-76	1-2	50624	3-16	50810	3-26	5098T	4-41	5146	4-35
4622	7-27	50234	1-1	5063	4-38	50811	3-26	5098XL	4-39	5151	4-40
4622-27	7-27	50234-107	1-1	50634	3-20	5081-24	3-17	5098XLT	4-42	5151L	4-40
4622-4	7-27	50235	1-2	50636	4-44	50812M	3-22	5099L	4-39	5151LT	4-42
4622-8	7-27	50235-101	1-3	50637	4-43	50813M	3-23	5099LT	4-42	5151T	4-42
4641	7-52	50235-110	1-4	50638	4-47	50814	2-18	51010T	4-44	5157N	2-84
465...	10-45	50235-124	1-3	50638A	4-48	50816	4-48	51016N	2-83	5161	3-8
465100...	10-46	50235-187	1-3	50639	4-47	50817	3-20	5102	4-30	51612C	3-9
4652	7-52	50235-88	1-4	50639A	4-48	5081S	3-18	51025C	3-5	5162SP	3-12
4653	7-28	50253	1-8	5063T	4-40	5082	3-1	5102L	4-31	5164	3-21
46560...	10-46	50254	1-9	5064	2-57	50821	3-19	5102LB	4-36	5164R	3-23
46585...	10-46	50311	2-18	5064L	2-57	50821A	3-19	5102XL	4-31	5171	2-57
466...	10-47	5033	3-2	5065	3-14	50829	3-4	5102XLB	4-36	51710C	3-8
466110...	10-47	5034	2-17	50651	3-6	5083F	4-38	5103	3-4	5172	3-2
468...	10-47	50352	1-7	50651A	3-6	5083TF	4-41	5103AS	3-6	5176	3-3
4682	7-29	50352-129	1-7	50651S	3-10	5084	3-4	5106B	4-44	5191C	3-9

Part No.	Page	Part No.	Page	Part No.	Page	Part No.	Page	Part No.	Page	Part No.	Page
5191Q	3-14	605...	2-51	6163S	10-41	62504	2-147	647C...	2-14	65604	2-40
5192	3-13	606...	2-51	616A...	2-53	62505	2-147	647H...	2-10	65605	2-41
52010S	3-12	606...Q	2-51	616A400	2-53	62509	2-148	647H...	2-11	65608	2-41
5209SC	3-12	607...	2-51	616A700	2-54	62512	2-148	647H...-72	2-10	65641	2-40
5213C	3-9	607...Q	2-52	616B...	2-52	62518	2-141	647H...-72	2-12	656A	2-38
5221C	3-10	6071	10-38	616F...	2-52	62519	2-142	647P...	2-14	656AM	2-38
525...	5-17	608...	2-126	616G...	2-53	62520	2-142	647P...	2-44	656B	2-39
52550...	5-18	6081	10-38	617	2-77	62522	2-142	648...	4-64	656B01	2-39
526...	5-18	6081D	10-39	61701	2-77	62525	2-142	648...L	4-64	656BM	2-39
5261	3-10	6081DS	10-41	61702	2-78	62528...	2-31	6480607	4-64	656F	2-38
5261C	3-10	6081S	10-40	61703	2-77	6261	8-5	649...	2-33	656M	2-38
52650...	5-18	6082D	10-39	617L	2-77	627...	2-143	649...A	2-33	65701	2-149
527...	5-19	6082DS	10-41	618	2-71	628...	2-145	649...AL	2-34	65714...	2-149
52750...	5-19	6083	10-38	61802	2-72	62801	2-143	649...E	2-34	658	2-146
529...	5-20	6083D	10-39	61803	2-72	62802	2-143	649...L	2-33	65802	2-146
52950...	5-20	609...ABC	2-25	6181	8-2	62805	2-143	649200C	2-34	65803	2-145
52Q...	5-21	609...ABO	2-25	6181-5	8-2	62806	2-144	649200D	2-34	65805	2-146
52Q50...	5-21	609...ASC	2-25	618L	2-71	62811	2-144	649M...	2-89	65901...	2-109
535...	6-21	609...ASO	2-25	619	2-136	62812	2-144	649N...	2-90	65902...	2-110
53546...	6-22	6091	10-42	61901	2-138	628E...	2-144	65001	2-130	65903...	2-110
53563...	6-22	6091S	10-42	61901A	2-139	6291	8-5	65014	2-130	65909...	2-110
536...	6-22	6092D	10-40	61901A	2-31	63005	2-63	65019	2-130	65909Q...	2-111
536...	6-23	610...	2-21	61902	2-137	63005B	2-63	65101	2-14	65910	2-117
537...	6-23	610110	2-21	61903	2-137	63006	2-63	65102	2-14	65910...	2-111
53763...	6-23	610B...	2-21	61904	2-136	63006B	2-64	65103	2-15	65910Q...	2-111
539...	6-24	610B...B	2-21	61904A	2-136	63008	2-135	65104	2-15	660...	2-32
53963...	6-24	611...	2-21	61906...	2-138	634...	2-148	65106	2-15	660...D	2-32
539N...	2-84	6111	10-42	61908	2-137	634...A	2-149	65107	2-15	66101	2-32
53Q...	6-25	6111-6	10-42	61909	2-138	639...	2-139	65111L	2-15	66201	2-32
53Q63...	6-25	6111D	10-43	61910...	2-138	639230	2-140	65112L	2-16	66301	2-54
545...	7-61	6111D-6	10-43	61911	2-139	64101	2-135	65113L	2-16	66302	2-54
54577...	7-62	6112	10-38	61912	2-137	647...	2-5	65202	2-31	66303	2-54
546...	7-63	6113	10-41	61913	2-136	647...	2-6	653...	2-42	66431	2-115
546150...B	7-63	6115D	10-40	61914	2-139	647...	2-7	65303	2-42	66432	2-115
54677...	7-63	611B...	2-22	620...	2-140	647...P	2-4	65304	2-42	664P	2-115
547...	7-63	612140	2-22	6201	8-2	647...W	2-8	65305	2-43	666...	2-114
54777...	7-64	612175	2-22	6201-5	8-2	64701L	2-2	65306	2-43	66601	2-112
548W...	7-64	612B...	2-22	6201S	8-4	64702L	2-2	653180	2-42	66602	2-112
549...	7-65	613...	2-23	62102	2-140	64703	2-1	65401...	2-69	66610	2-112
54977...	7-65	613A500	2-23	62103	2-141	64703A	2-1	65402...A	2-70	66612	2-113
54Q...	7-66	613B250	2-23	62104	2-141	64704	2-4	65404...	2-69	66613	2-113
54Q77...	7-66	614...	2-30	62106	2-141	64705	2-4	65405...	2-69	66614	2-113
5501	4-43	6141	8-1	6212	8-2	64707	2-1	65406...	2-69	666140	2-114
565...	8-6	6141-5	8-1	6212-5	8-2	64709	2-2	65407...	2-70	66616	2-118
569...	8-7	6141B	8-1	6212S	8-5	64710	2-2	65408...	2-70	66617	2-121
585...	9-2	6141B-5	8-1	623...	2-140	64711	2-3	6551...	4-63	66617A	2-121
5861	2-35	6141S	8-4	6233	8-3						

Part No.	Page	Part No.	Page	Part No.	Page	Part No.	Page	Part No.	Page	Part No.	Page
66625	2-122	685B09...	2-11	712N...	4-65	765...G	4-71	802323	6-29	8044080L	7-72
66626	2-122	685C14...	2-13	713...	4-60	765...L	4-68	802327	6-29	80454430	7-72
66627	2-123	685D14...	2-13	713...M	4-61	765...XL	4-69	80233	6-27	8046...	8-9
66628	2-123	68601	2-80	713N...	4-65	766...	4-69	80234	6-27	8046...MPB	10-48
666A...	2-118	68602	2-80	714...	4-61	766...BL	4-70	80235	6-28	8046...MPP	10-48
666A01	2-119	68603	2-81	715...	4-62	766...L	4-69	80238	6-28	8048...	9-3
666A02	2-120	68607	2-81	716...	4-62	766...T	4-74	80239	6-28	8048...MPB	10-59
666A03	2-120	68608	2-81	716300...	4-62	766...XL	4-70	802412	7-69	8048...MPP	10-59
66901	2-67	68610	2-82	717...	4-62	767...	4-70	802415	7-69	80521	5-25
66902	2-67	68611	2-82	71817004A	4-64	767...G	4-72	802418	7-69	80521MPB	10-3
66903	2-67	68612	2-82	71F...	4-63	767...L	4-70	802418L	7-69	80525...	5-22
67001	2-66	687...	2-108	724...	4-72	767...XL	4-71	80242	7-68	8052565...	5-22
672...	2-68	687...	2-108	725...	4-72	768...K	4-71	802422	7-69	80531	6-30
673B...	2-23	687400H	2-108	726...	4-72	76F...	4-71	802423	7-70	80531E	6-30
674	2-129	68755	2-108	727...	4-73	774...	4-73	802426	7-70	80531MPB	10-8
67402	2-129	68790	2-108	731A...	4-66	774...A	4-75	802427	7-70	80531MPP	10-8
677...	2-126	6901225	2-85	733A...	4-66	774...B	4-75	80243	7-68	80535...	6-26
678	2-130	6902...	2-86	736A...	4-66	7743200N	2-85	802433	7-71	8053585...	6-26
67801	2-35	6903...	2-86	737A...	4-66	776...	4-74	802434	7-70	80536...	6-26
67802	2-36	6904...	2-86	744...	4-63	784...B	4-75	80244	7-68	80541	7-72
678260	2-36	6905...	2-87	744N...	4-65	784...U	4-76	80245	7-68	80541MPB	10-33
678535	2-36	6907250	2-87	750...	2-128	791...	3-41	80248	7-69	80541MPP	10-33
678810	2-37	6908160	2-87	751...	3-27	792...	3-42	80249	7-69	80545...	7-67
678N260	2-37	6909250	2-88	751...A	3-27	793...	3-43	8026500	8-8	80545108...	7-67
678N320	2-37	6911...	2-88	752...	3-28	794...	3-44	8026505	8-8	80546...	7-67
6801	2-93	6912160	2-88	753...	3-29	795...	3-45	8026820	8-8	80561	8-9
68010	2-96	6913160	2-89	753...A	3-29	796...	3-43	8028650	9-3	80561MPB	10-48
68011	2-95	6914...	2-89	753...R	3-29	8012140	5-22	8032115	5-24	80561MPP	10-48
68012	2-96	6921160	2-26	754...	3-30	8013200B	6-27	8033165	6-29	80581	9-3
68013	2-93	6922160	2-26	755...	3-31	8013215	6-27	8033200L	6-29	80581MPB	10-59
68015	2-94	6923...	2-26	755...A	3-32	8014...	7-68	8034...	7-70	80581MPP	10-59
6802	2-93	6924250	2-26	755...L	3-32	8014600	7-68	8034250L	7-70	806...	5-25
6803	2-94	6925...	2-26	755...Q	3-33	80161000	8-8	8036...	8-8	806...	6-30
6804	2-94	6927310	2-27	755S...	3-33	8016475	8-7	8036450L	8-8	80634	7-72
6804B160	2-95	6927600	2-27	756...	3-33	80181000	9-3	8038550	9-3	8071	10-51
6805A	2-95	6957240	2-28	756...A	3-34	8018650	9-3	803A4300	7-71	8073...	2-131
6806	2-95	6958...	2-27	756...F	3-28	802214	4-59	804...U	4-76	8073...	6-26
6807	2-94	6959180	2-27	757...	3-37	802215	5-23	80412...MPP	10-64	8073...B	2-132
6808	2-96	6961300	2-28	757...F	3-38	802218	5-23	8042...	5-24	8073...B	2-134
6809	2-96	6962350	2-28	757...R	3-38	802219	5-23	8042...MPB	10-3	8073...BM	2-132
681...	2-127	6963330	2-28	757S...	3-39	80222	5-22	8042...W	5-24	8073...BM	2-134
681600	2-128	6964...	2-29	758...	3-34	802220	5-23	80420...MPP	10-66	8073...M	2-131
681A300	2-127	6965265	2-29	758S...	3-35	802222	5-24	8043...	6-29	8073...M	6-26
681B400	2-127	6971...	2-29	759...	3-35	802223	5-24	8043...MPB	10-8	8073...MTH	2-131
681D515	2-128	6972180	2-29	760...	3-36	802227	5-24	8043...MPP	10-8	8073...MTH	6-27
6821	2-129	6976200	2-27	760...A	3-36	80224	5-22	8043...R	6-30	8073...U	2-133
684...	2-43	698...	2-56	760M...	3-36	80225	5-22	8043...W	6-30	8073...U	2-134
684...A	2-44	6982	2-55	761...	3-36	80228	5-23	80435...	10-7	8073...UM	2-133
684C...	2-44	6983	2-55	761...A	3-37	80229	5-23	80435...M	10-8	8073...UM	2-134
68509...	2-10	6985	2-56	762...	3-37	802315	6-28	8043N...	2-84	8073250...M	2-131
68514...	2-12	711...	4-60	764...	4-67	802318	6-28	8044...	7-71	8074...	7-67
68520...	2-13	711...M	4-61	764...L	4-67	802319	6-28	8044...MPB	10-33	8074...	2-132
685A09...	2-11	711N...	4-65	764...T	4-74	80232	6-27	8044...MPP	10-33	8074...M	7-67
685A14...	2-12	712...	4-60	764...TA	4-74	802320N	2-85	8044...R	7-71	8074...M	2-132
685A20...	2-13	712...M	4-61	764...XL	4-68	802322	6-29	8044...W	7-72	8074...U	2-133

Part No.	Page	Part No.	Page	Part No.	Page	Part No.	Page	Part No.	Page	Part No.	Page
8074...U	2-135	8141	9-1	82563	10-49	887D01	2-105	9U0221	2-100	PI8034	7-74
8074...UM	2-133	8141S	9-1	82566	10-50	887P01	2-106	9U0311	2-98	R1335	10-9
8074...UM	2-135	8142	5-26	82585	10-60	887P02	2-106	9U0312	2-99	R1635	10-9
8081	10-51	8143	5-26	82585S	10-60	887P03	2-106	9U0313	2-99	R1935	10-34
8081D	10-52	8144	4-59	82586	10-61	88801	2-97	9U0401	2-76	R2435	10-34
8081DS	10-53	8145	5-26	82586L	10-61	88802	2-97	9U0501...	2-28	R3355	10-49
8081S	10-52	8148	4-59	825A41L	10-67	88803	2-97	9U1001	2-68	R3755	10-49
8082	10-51	8149	5-27	825A41L-B	10-67	88804	2-98	9U10A...	2-59	R4455	10-49
8082D	10-52	8152	4-59	826...	3-40	88901	2-78	9U10B...	2-59	R4455	10-60
8082DS	10-53	8152370A	5-27	82601	10-37	88902	2-78	9U1101	2-67	R7555	10-60
8082S	10-52	8152R	4-60	82602	10-37	891...	2-74	9U1102	2-67	T2173A	4-28
8083	10-51	8153360A	6-31	827...	3-39	891A01	2-75	9U3001	2-152	T31010	2-124
8083...	6-30	8154...	7-73	82731	10-11	891B01	2-75	9U3003	2-152	T40813	10-15
8084...	7-72	8154410A	7-73	82733	10-11	904M3	2-150	9U39...	2-102	T40813-5	10-15
8086...	8-9	8156...	8-9	827A31L	10-67	904U2	2-107	9U3921	2-101	T4322	7-16
8091	10-54	8158650	9-4	827A31L-B	10-68	904U4	2-151	9U4501	2-101	T4355	7-16
80912...MPP	10-64	815A4315	7-71	827B02	10-70	904U5	2-107	G81	2-98	T4413	7-20
8091D	10-54	8162	5-27	827B03	10-70	904U6	2-107	K2139	10-1	T5044	3-16
8091MD	10-54	8163	6-32	827M...	3-39	905G6	2-151	K2139-2	10-1	T5052	3-6
8092...	4-58	8164	7-74	828...	3-39	905M1	2-150	K2231	10-1	T50633AF	2-47
80920...MPP	10-66	8166	8-9	828A21L	10-68	905T2	2-145	K2231-2	10-1	T50710	3-1
80922	4-58	8168	9-4	828A21L+825B036L	10-68	905T6	2-116	K2463	4-8	T50918	3-1
80922175	4-58	818...	2-58	828A22	10-69	905U1	2-62	K3021	2-124	T51115	3-26
80923	5-25	818A	2-58	828A22+825B120	10-69	906U2	2-60	K3133	10-5	T5114	3-3
80923036	5-25	818B...	2-59	829...	2-90	907U2	2-68	K3133-3	10-5	T51226	3-19
80923MPB	10-3	8192...	5-27	829A...	2-90	908U2	2-64	K4032	10-12	T51226A	3-20
8093...	6-31	8193...	6-31	830...	2-90	909U1	2-65	K4033	10-13	T51315	3-25
8093...MPB	10-9	8193T	6-31	831...	3-40	910...	2-65	K4079	10-20	T51811	2-35
8093...MPP	10-8	8194...	7-74	8334300	7-71	910T1	2-116	K4087	7-18	T5303	4-43
80934062	6-31	8194T	7-73	87901	2-56	910U1	2-62	K4088	10-20	T5303S	4-43
8094...	7-73	8211	9-1	88001	2-79	910U2	2-60	K4099	10-13	T6085	10-40
8094...MPB	10-34	8211S	9-1	88002	2-79	912...	2-65	K50411	3-25	T6121	10-39
8094...MPP	10-33	822...	3-45	88003	2-80	912U3	2-60	K50625	3-25	T8151	10-53
80943066	7-73	823...	2-109	88004	2-80	9130U1	2-65	K50812F	3-24	T905M2	2-150
8095...	4-58	823A...	2-109	88011	2-78	915U1	2-66	K51210F	3-24		
8096...	8-9	824...	3-40	88012	2-79	920U1	2-66	K51216	3-24		
8096...MPB	10-48	82421	10-3	88013	2-79	920U3	2-64	K5156	3-22		
8096...MPP	10-48	82422	10-3	881...	2-61	924...	2-65	K5156R	3-23		
8098...MPP	10-59	82432	10-10	881A...	2-61	924U1	2-61	K6072	8-1		
80986	9-4	82433	10-10	88201	2-148	925U1	2-62	K64706	2-1		
80986MPB	10-59	82441	10-35	88401	2-91	929...	2-65	K64706S	2-1		
81022	5-25	82443	10-35	88402	2-91	938U1	2-151	P1425	10-9		
81022M	5-25	82445	10-35	88403	2-91	943U1	2-67	P1625	10-9		
8103...	6-31	825...	3-40	88404	2-92	9G0115	2-31	P2030	10-34		
8103...MPB	10-9	825121	10-64	88407	2-92	9G1801	2-75	P2530	10-34		
8104...	7-73	82531	10-10	88408	2-92	9G1801A	2-75	P3040	10-49		
8104...MPB											



FORCE®

Shyang Yun Tools Co., Ltd.

No.161, Sitou Rd., Shengang Dist., Taichung City 42953, Taiwan

Tel: +886-4-25631268 Fax: +886-4-25632678

<http://www.force.com.tw> E-mail: info@force.com.tw